

RF Measurements of a Traveling-Wave Muffin-Tin Accelerating Structure at 90 GHz*

P.J. Chou, G.B. Bowden, M.R. Copeland, A. Menegat, D.P. Pritzkau, and R.H. Siemann
Stanford Linear Accelerator Center, Stanford University, California 94309

H. Henke
Technical University Berlin, EN2, Einsteinufer 17, D-10587 Berlin, Germany

Abstract

A measuring system at the table-top scale was developed for RF measurements of a muffin-tin accelerating structure operating at 32 times the SLAC frequency (2.856 GHz). Both perturbation and non-perturbation methods are employed to characterize the RF properties of a muffin-tin structure. Conventional bead pull measurements are extended to millimeter wavelengths. Design of the measuring system and preliminary results of RF measurements are presented.

Paper Contributed to the 1997 Particle Accelerator Conference

Vancouver, B.C., Canada, 12-16 May 1997

* Work supported by Department of Energy contract DE-AC03-76SF00515.

RF MEASUREMENTS OF A TRAVELING-WAVE MUFFIN-TIN ACCELERATING STRUCTURE AT 90 GHz [†]

P.J. Chou, G.B. Bowden, M.R. Copeland, H. Henke*, A. Menegat, D.P. Pritzkau, and R.H. Siemann

Stanford Linear Accelerator Center, Stanford University, California 94309

ABSTRACT

A measuring system at the table-top scale was developed for RF measurements of a muffin-tin accelerating structure operating at 32 times the SLAC frequency (2.856 GHz). Both perturbation and non-perturbation methods are employed to characterize the RF properties of a muffin-tin structure. Conventional bead pull measurements are extended to millimeter wavelengths. Design of the measuring system and preliminary results of RF measurements are presented.

I. INTRODUCTION

A relatively low cost, fully automated measuring system which is capable of measuring both the phase and amplitude of microwave signals in the 90 GHz frequency range was constructed. A precision platform for bead pull measurements was also constructed in order to characterize the RF properties of a traveling-wave muffin-tin accelerating structure at 90 GHz[1]. The measuring system was built by combining standard RF measuring equipments and some home-built components together. All equipment and data acquisition are controlled by a PC running with the commercial software package LabVIEW[®]. A support fork mounted on a 1-dimensional optical translation stage was built to hold a tiny fiber used in the bead pull measurements. The movement of the fiber was controlled by a servo motor driven translation stage with a 1 μ m resolution. Preliminary results and ideas for further improvement are presented.

II. HOME-MADE MM-WAVE VECTOR NETWORK ANALYZER

The block diagram of the W-band vector network analyzer is depicted in Fig. 1. The mm-wave power is generated by multiplying the frequency of a Hewlett Packard (HP) 8673D microwave source with a HP 85100W $\times 5$ mm-wave frequency multiplier. The resultant mm-wave power goes through two directional couplers (reference: Hughes 45326H-1120 and signal: Hughes 4532641-1320) and some WR10 waveguides and then is fed into the test structure.

W-band signals from the directional couplers are mixed down to an intermediate frequency, $f_{IF} = 835.216$ MHz, using HP 11970W waveguide mixers. The local oscillator (LO) frequency is multiplied by $\times 18$ in the

waveguide mixers before mixing, so the first stage LO frequency is in the 5 GHz range. This LO frequency is changed when the W-band frequency is changed to keep f_{IF} constant. The signals are amplified by 40 dB with Q-Bit QBS 135 narrowband, low noise (Noise Figure < 1 dB) amplifiers and then mixed down to audio, 16 kHz, using an EM Research SLS-849-ER-01 phase locked loop as the second stage LO. The outputs of the second stages of mixing are low-pass filtered.

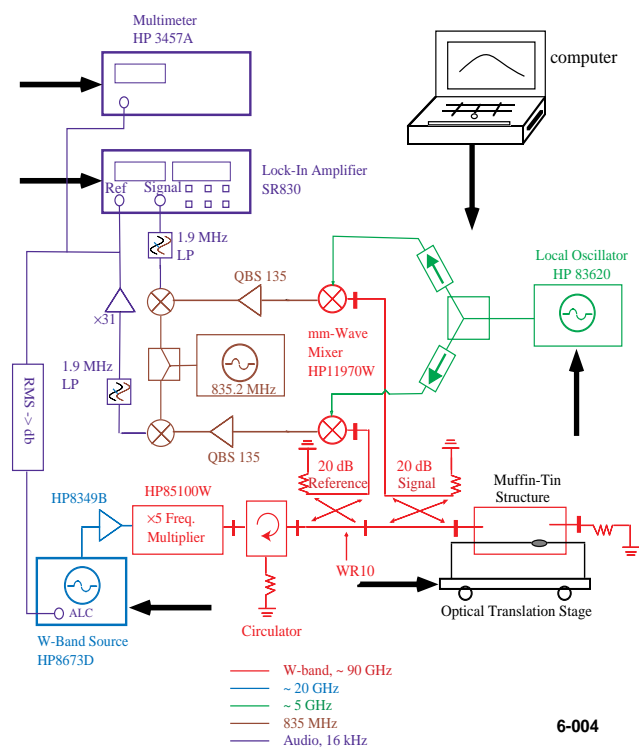

Fig. 1: Block diagram of mm-wave vector network analyzer configured for reflection measurements.

The processed output of the first directional coupler, the reference coupler, is amplified with a $\times 31$ audio amplifier and then used in several ways: i) it is measured with an HP 3457A multimeter; ii) it is the reference input for an Stanford Research Systems SR830 lock-in amplifier; and iii) it is converted to dB to level the HP 8673D microwave source.

The processed output of the signal coupler is connected directly to the signal input of the lock-in amplifier which measures i) the amplitude of the signal at the frequency of the reference input and ii) the phase between the reference and signal inputs. A key to the phase measurement is balanced splitting of the first stage LO output.

[†] Work supported by Department of Energy contract DE-AC03-76SF00515.

*Permanent Address: Technical University Berlin, EN2, Einsteinufer 17, D-10587 Berlin, Germany.

For transmission measurements, the signal coupler is connected to the output port of the test structure (Fig. 2). This is done rather than connecting the waveguide mixer directly because it allows use of the same calibration intercepts (see below).

Calibrations of the reference and signal arms were performed using an HP 437B power meter and HP W8486A power sensor. A typical setup is shown in Fig. 3. Measurements showed that the reference and signal voltages, measured in dBV, were linear in the power in dBm with intercepts, K, that are a function of frequency

$$\text{Voltage(dBV)} = \text{Power(dBm)} + K$$

The intercepts vary by ~ 1 dB over the frequency range from 85 to 95 GHz, and the frequency dependence was reproducible when measurements were taken several weeks apart during a time when the analyzer was taken apart and reassembled several times (Figs. 4 and 5). There was a systematic change of 0.24 dB in the intercept of the reference channel during this time. We suspect that the $\times 31$ amplifier is drifting and plan to replace this home-built amplifier with a high quality commercial one.

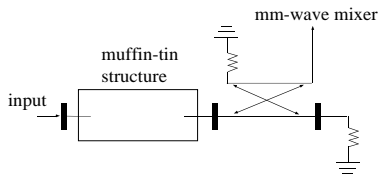

Fig. 2: Configuration for the transmission measurements.

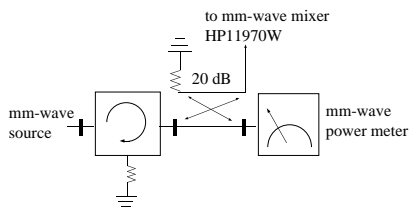

Fig. 3: Configuration of the calibration measurements.

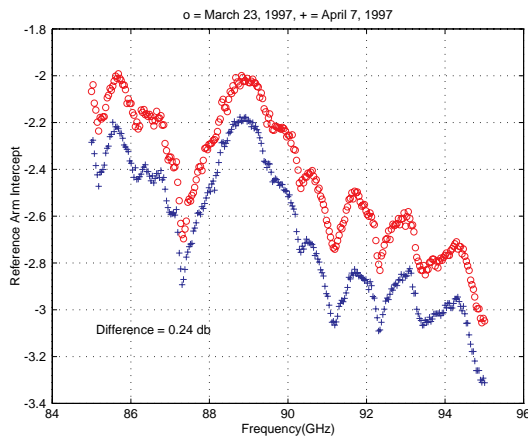

Fig. 4: Reference channel calibrations performed at two different times.

III. PRELIMINARY RESULTS OF RF MEASUREMENTS

The 7-cell muffin-tin structure[1] was designed with the computer code MAFIA[2]. The reflection and transmission coefficients are shown in Figs. 6 and 7 respectively. Note that only 4 cavity cells were used in the simulation.

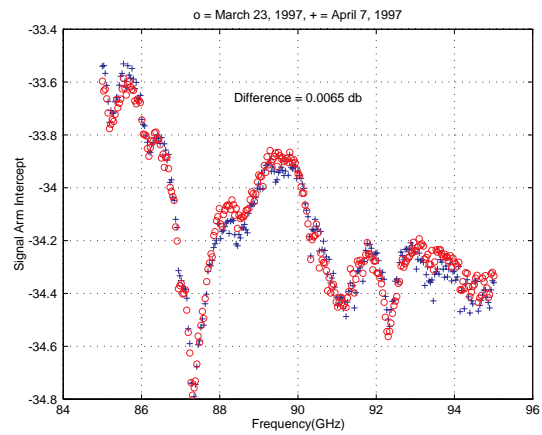

Fig. 5: Signal channel calibrations performed at two different times.

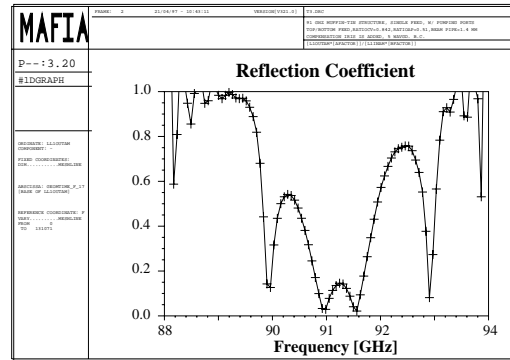

Fig. 6: Simulated frequency response of the reflection coefficient.

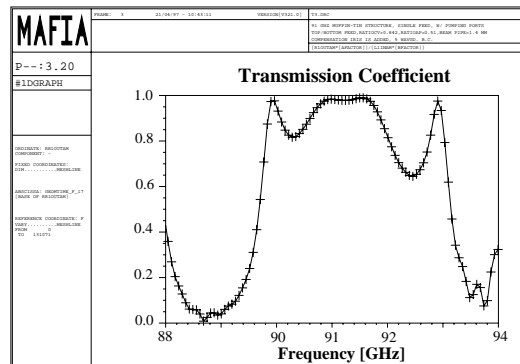

Fig. 7: Simulated frequency response of the transmission coefficient.

The measured reflection and transmission coefficients are depicted in Fig. 8. The measured frequency response is in good qualitative agreement with the simulation except for the magnitude of the transmission coefficient. The sum of the squares of the reflection coefficient and the transmission coefficient is shown in Fig. 9. From energy conservation, we expect the sum to be one. There

is some unexpected power loss in the passband. Roughly 50% of the input power is accounted for. We repeated the measurement with the beam pipe and pumping slot closed, and only a few percent change was observed. We suspect that the surface roughness of the structure may be the cause. Experimental investigation is underway to understand this extra power loss.

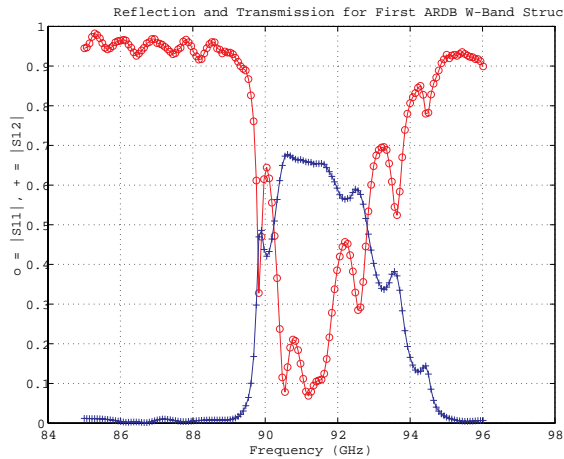

Fig8: The measured frequency response of the reflection coefficient for a 7-cell structure.

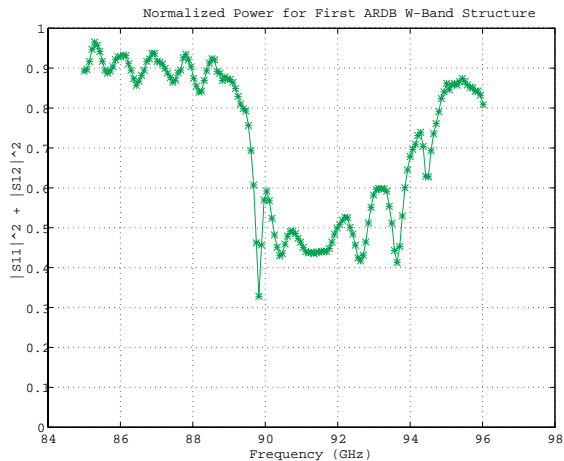

Fig9: The sum of the squares of the reflection coefficient and the transmission coefficient.

For a traveling-wave structure, the accelerating field along the longitudinal axis of the structure has the following expression:

$$E_z(z) = |E(z)| e^{-j\phi(z)}$$

where $\phi(z)$ is the phase advance along the structure. In non-resonant perturbation measurements (a perturbing object was placed inside the accelerating structure and the reflection coefficient at the input was measured. The difference between the unperturbed input reflection coefficient S_{11}^p and the perturbed reflection coefficient S_{11}^p provides information on both the amplitude and phase of the accelerating field:

$$DS_{11}(z) = a |E(z)|^2 e^{-2j\phi(z)}$$

where a is a constant depending on the input power level and the shape of perturbing object.

For bead pull measurements, a nylon string with a diameter around 50 μ m was threaded through the side pumping slot and moved along the longitudinal direction. Figures 10 and 11 depict the preliminary results of the measured amplitude and phase at 91.39 GHz along the 7-cell traveling-wave structure.

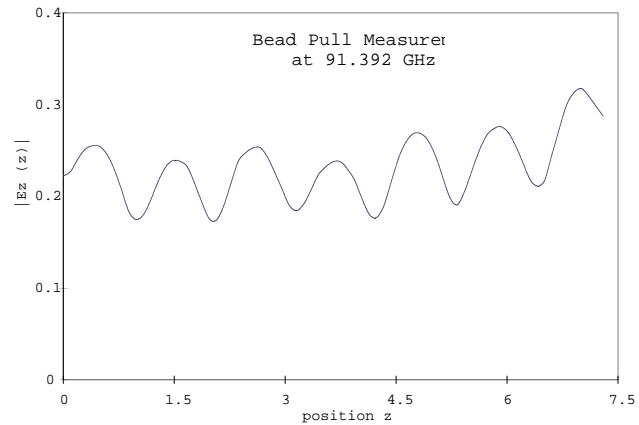

Fig10: The measured amplitude in arbitrary units of the accelerating field along the structure.

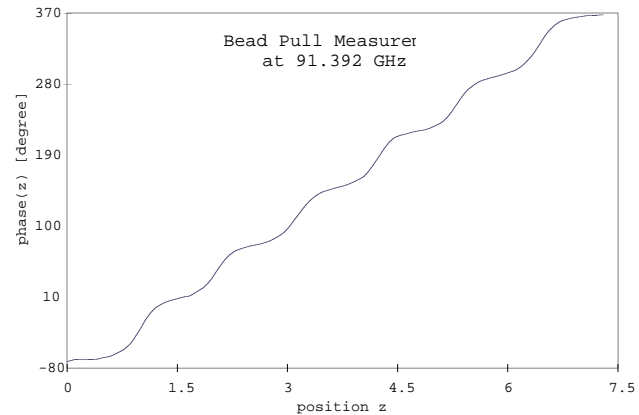

Fig11: The measured phase advance (degrees) of the accelerating field along the structure.

IV. ACKNOWLEDGMENT

The authors would like to thank N.M. Kroll, R.H. Miller, C.K. Ng, and J.W. Wang for many helpful discussions.

V. REFERENCES

- [1] P. J. Chou, et al., Design and Fabrication of a Traveling-Wave Muffin-Tin Accelerator Structure at 90 GHz, in this proceeding.
- [2] The MAFIA Collaborators, Forbels et al., MAFIA User Guide, 1992.
- [3] K.B. Mallory and R.H. Miller, IEEE Trans Microwave Theory and Tech., 14 (1966) 99.