

On Mediating Supersymmetry Breaking in D-brane Models

John H. Brodie

Stanford Linear Accelerator Center

Stanford University

Stanford, CA 94305, USA

Abstract

We consider the 3+1 visible sector to live on a Hanany-Witten D-brane construction in type IIA string theory. The messenger sector consists of stretched strings from the visible brane to a hidden D6-brane in the extra spatial dimensions. In the open string channel supersymmetry is broken by gauge mediation while in the closed string channel supersymmetry is broken by gravity mediation. Hence, we call this kind of mediation “string mediation”. We propose an extension of the Dimopoulos-Georgi theorem to brane models: only detached probe branes can break supersymmetry without generating a tachyon. Fermion masses are generated at one loop if the branes break a sufficient amount of the ten dimensional Lorentz group while scalar potentials are generated if there is a force between the visible brane and the hidden brane. Scalars can be lifted at two loops through a combination of brane bending and brane forces. We find a large class of stable non-supersymmetric brane configurations of ten dimensional string theory.

January 2001

1. Introduction

There has recently been a trend in particle physics of building models of nature in which the Standard Model fields live on a brane while gravity is allowed to propagate in more than 3+1 dimensions [1][2][3]. Such a scenario is very easily incorporated into string theory which naturally has ten dimensions and D-branes, walls on which open strings propagate [4]. It is therefore not unfeasible to realize some of the large extra-dimension scenarios explicitly in string theory. However, to do so one would need a mechanism of supersymmetry breaking for the brane theories since all consistent string theories have supersymmetry. This is the topic of this paper. It has been known for some time that it is undesirable to break supersymmetry explicitly in the MSSM fields (Minimal Supersymmetric Standard Model) as this generically generates tachyons in the visible spectrum[5]. One must first break supersymmetry in some heavy non-MSSM messenger fields and then communicate the supersymmetry breaking to the Standard Model fields. Traditionally the communication was done through the only fields which couple to both the MSSM fields and the messenger sector: gravity or the Standard Model gauge fields. In this paper we will consider all of these same issues in the brane scenario. We find that one should not break supersymmetry directly on our brane, instead to avoid having tachyons one should introduce other branes separated from our brane by extra dimensions. The role of the messenger fields is played by the strings stretching from the visible brane to the hidden brane. In string theory, because of channel duality which relates properties of closed strings to properties of open strings, there are then two ways to view the supersymmetry breaking mediation. The first way is to view the messenger fields as a tower of extremely heavy open-string fields that couple to the massless gauge fields on the visible brane. Integrating out the massive messenger fields at 1-loop induces masses for the scalars and fermions in the visible spectrum. The other way to view the mediation is as massless closed string fields which couple to the D-brane world volume action giving visible fields masses at tree-level. The first method is similar to gauge mediation while the second method is similar to gravity mediation. We call our proposal “string mediation” because open-string close-string duality relates the two methods.

The mechanism we use for breaking supersymmetry in the messenger open-string sector is rotations in the extra dimensions of the hidden branes with respect to the visible branes. An important point of our study is that one can determine if fermion masses are lifted in a brane construction simply by looking at the Lorentz symmetry that is preserved

by the branes themselves. These Lorentz symmetries of the extra dimensions correspond in the 3+1 brane world to global symmetries and can protect the fermions from getting a mass. It is a somewhat surprising fact that there is a large class of non-supersymmetric brane models in string theory which have a high degree of global symmetries. It is therefore a general results of our study are that many generic supersymmetry breaking rotations of branes are no good for phenomenology because they do not sufficiently break the global R-symmetries, generate only a D-term for the messenger fields, and therefore do not lift the gaugino. Fortunately we find that there is a large class of $N = 1$ brane constructions where turning on what is often called an F_S term is possible and the gaugino can be lifted. Scalar potentials are equally easy to understand from the ten dimensional point of view: They correspond to forces between the branes. Often what will happen in that attractive forces between two types of branes will be countered by the fact that the branes are stuck to larger, heavier branes resulting in a massive scalar in the field theory. Although the larger heavier branes will bend, the bending is energetically costly and so will balance against the attraction of the smaller, lighter branes. In fact, the bendings themselves often can be interpreted as expectation values for D-terms, wave-function renormalizations, or other perturbative phenomena. We find many stable, non-supersymmetric configurations. One can understand the stability as coming from the boundary conditions of the larger, heavier branes which extend off to infinity in uncompactified ten dimensional space-time.

The topic of this paper is interesting because eventually one would like to model the MSSM using branes in string theory (see [6][7]) and one will need to break supersymmetry in a brane model and calculate the light spectrum of states. String mediation seems to be the most natural way to accomplish this. Moreover, there is some hope that the non-supersymmetric brane configurations might be useful for studying strong coupling dynamics of non-supersymmetric theories. ¹

The outline of the paper is as follows: In section 2, we review open-closed string channel duality and explain the general mechanism of string mediated supersymmetry breaking using detached probe branes. In section 3, we present some models where the scalars are lifted at 1-loop and at 2-loops and a model where the gaugino is lifted at 1-loop.

¹ Perhaps as suggested in [8] strong dynamics can be understood by including only Euclidian D0-brane which play the role of instantons in the gauge theory but not including Lorentzian D0-branes which are five dimensional Kaluza-Klein modes. This limit is different from the M-theory limit where one has both kinds of D0-branes.

One of these scalar potentials looks suggestively like an inflaton potential that might be relevant for cosmology. In section 4, we look at the general rotations of branes and explain to which spurion each rotation corresponds. In section 5, we explain how turning on fluxes is another mechanisms for breaking supersymmetry in the messenger sector and see how it is related to mechanism of detached rotated probe branes. In section 6, we present a method for having first and second order phase transitions in brane constructions which might be relevant for modeling the Standard Model Higgs field.

A number of other papers have dealt with the issue of supersymmetry breaking in brane world scenarios such as anomaly mediation [9], gaugino mediation [10], radion mediation [11], and in Horava-Witten scenarios [12].

2. String Mediated Supersymmetry Breaking

In this section we will review open-string closed-string channel duality and explain how it relates to gauge and gravity mediated supersymmetry breaking on the visible brane.

2.1. String theory and the annulus diagram

The fundamental process we will use for communicating supersymmetry breaking is the string annulus diagram. In string theory, the annulus diagram, a two-dimensional world sheet with one hole and two boundaries, has two interpretations: with time running radially, it is a close string exchange between two tensionful branes. With time running vertically, it is an open string loop. The close string interpretation is more useful when the branes are separated by a distance much larger than $\sqrt{\alpha'}$. In this limit, the supersymmetry breaking is communicated via tree level gravitons from the hidden brane to the visible brane, and massive string modes can be neglected. In fact, in this paper all of the “field theory” calculations will be done using the p-branes in the supergravity background of a p'-brane. The open string interpretation is more useful when the branes are separated by a distance less than $\sqrt{\alpha'}$. In this limit the supersymmetry breaking is communicated via field theory loop diagrams of light scalar and fermion fields that propagate in both the hidden and the visible brane.

2.2. Closed string channel and supergravity.

Since the long distance limit of the close string theory is supergravity we can calculate the long distance force between branes using only the brane action and supergravity. We will explain how to do that now (see also for example [13][14][15]). In the configuration of branes with 4ND boundary conditions, where N is for Neuman and D is for Dirichlet, the velocity independent forces cancel between graviton and dilaton ². In the non-supersymmetric limit where the supergravity forces don't cancel, they appear in the brane action as potentials for the scalar field. The way this works is the following: The metric for a p'-brane is

$$ds^2 = f(r)^{-1/2} dx_{\parallel}^2 + f(r)^{1/2} dx_{perp}^2 \quad (2.1)$$

where x_{\parallel} are the coordinates parallel to the brane, x_{perp} are the coordinates perpendicular to the brane, and

$$f(r) = 1 + g_s \left(\frac{\sqrt{\alpha'}}{r} \right)^{7-p'}. \quad (2.2)$$

The dilaton obeys the equation

$$e^{-2\phi} = f^{\frac{p'-3}{2}} \quad (2.3)$$

(see for example [16][14].) The action for the p-brane is

$$S_p = \int d^{p+1}y e^{-\phi} \sqrt{\det G(y)} \quad (2.4)$$

where $G_{\mu\nu}(y)$ is the pullback of the 10d p'-brane metric onto the p-brane.

$$G_{\mu\nu}(y) = h_{IJ}(x) \partial_{\mu} x^I \partial_{\nu} x^J \quad (2.5)$$

where $h_{IJ}(x)$ is given by the line element in (2.1) and $\mu = 0 \dots p$ and $I = 0 \dots 9$.

Plugging (2.1) and (2.3) into (2.4) we find for parallel p and p'-branes

$$S_p = f(r)^{\frac{p'-3}{4}} f(r)^{\frac{-(p+1)}{4}} (1 + f(r) \partial_{\mu} X^i \partial^{\mu} X_i + \dots) \quad (2.6)$$

where $i = p + 1, \dots, 9$. Expanding out the potential in (2.6) we see that

$$V_p(r) = 1 + \left(\frac{p'-3}{4} \right) \left(\frac{\sqrt{\alpha'}}{r} \right)^{7-p'} - \left(\frac{p+1}{4} \right) \left(\frac{\sqrt{\alpha'}}{r} \right)^{7-p'} + \dots \quad (2.7)$$

² In the 0ND supersymmetric limit the graviton and dilaton cancel against the RR field.

For $p' - p = 4$ the dilaton force cancels the gravitational force. For Dp parallel to a Dp' brane this corresponds to the 4ND supersymmetric boundary condition.

Now let us consider a non-supersymmetric configuration of BPS branes at an angle θ which will be our main way of breaking supersymmetry as will be discussed in more detail below. Because of the form of the metric (2.1), directions of the p-brane parallel to the p'-brane increase the exponent of f in the potential (2.7) by $\frac{1}{4}$ while directions of the p-brane perpendicular to the p'-brane decrease it by $\frac{1}{4}$. For a brane at an angle θ the formula for the potential is then

$$V_p = f^{\frac{p'-3}{4}} f^{-\frac{p}{4}} (\sin^2 \theta f^{1/2} + \cos^2 \theta f^{-1/2})^{\frac{1}{2}} \quad (2.8)$$

For the case $p' - p = 2$ and $\theta = 0$, the potential (2.8) vanishes. This is the 4ND condition for a Dp perpendicular to a Dp'. However for very small θ and $r \gg \sqrt{\alpha'}$ (2.8) becomes

$$V_p = M_s^{p+1} \left(\frac{1}{g_s} + \theta^2 \left(\frac{\sqrt{\alpha'}}{r} \right)^{7-p'} + \dots \right) \quad (2.9)$$

If we set $\phi = M_s^2 r$, then (2.9) is the potential that a scalar field, ϕ , on the p-brane experiences.

2.3. Open string channel and 1-loop potentials.

In the open string channel, the strings are charged under the hidden and visible sector. Quantum mechanically the heavy messenger fields have a zero point energy which contributes to the vacuum energy of the theory and can give rise to scalar potentials. Let us review some facts about calculating such potentials in quantum field theory using the methods of Coleman and Weinberg. Supersymmetric theories are special in having flat potentials since the fermion and boson zero point energies exactly cancel. Generically, in non-supersymmetric theories potentials are generated by quantum corrections to the vacuum energy at 1-loop [17].

$$\begin{aligned} V &= \sum_{\omega} (-1)^F \frac{1}{2} \omega = \sum_I (-1)^F \int d^{D-1} k \sqrt{\vec{k}^2 + m_I^2} \\ &= \sum_I (-1)^F \int d^D k \log(k^2 + m_I^2) = \sum_I (-1)^F \int d^D k \int \frac{dt}{t} e^{-t(k^2 + m_I^2)} \\ &= \sum_I (-1)^F \int \frac{dt}{t^{D/2+1}} e^{-m_I^2 t} \end{aligned} \quad (2.10)$$

In softly broken supersymmetric field theories with one light multiplet of mass M , these potentials take on the form

$$V = \delta M^4 \log M^2 \quad (2.11)$$

where M is the supersymmetric mass and where

$$\text{Str} M^2 = \text{Tr}(-1)^F M^2 = 0. \quad (2.12)$$

Here F is the number of fermions and M is the mass of the multiplet. However, a theory with an infinite tower of massive fields such as string theory can yield different potentials after one sums all the contributions from the individual fields .

$$\sum_{I=0}^{\infty} \delta M^4 \log(M_I^4). \quad (2.13)$$

In fact, string theory tells us what the sum of all the field theory potentials is because there is a dual description in terms of supergravity. The duality is defined in terms of modular functions where schematically

$$\sum_{n=1}^{\infty} e^{-nt} = f(e^{-\pi t}) = f(e^{-\frac{\pi}{t}}). \quad (2.14)$$

Where n is the level of string excitation defined by

$$M_n^2 = \left(\frac{L}{\alpha'}\right)^2 + \frac{n + \theta}{\alpha'} \quad (2.15)$$

(see Appendix C). For a parallel D4-brane and D6-brane separated by a distance much larger than the string scale $M = M_s^2 R$ where $R \gg \sqrt{\alpha'}$, one can show, by plugging the mass formula (2.15) into the Coleman-Weinberg formula (2.10) and using a modular transformation (2.14), that the sum (2.13) is in this case equal to

$$V = M_s^4 \left(\frac{1}{g_{YM}^2} + \frac{M_s}{M} \right). \quad (2.16)$$

2.4. Mechanism of tree level supersymmetry breaking in the messenger sector: rotation of detached probe brane.

In this section we will explain how supersymmetry breaking can be communicated to a visible p-brane from a rotated probe p'-brane located a distance R away via fundamental strings. The combination of the p-brane and the p'-brane breaks supersymmetry globally

in the ten dimensional space-time. The strings that stretch between the p-brane and the p'-brane which we call p-p' strings are the heavy messenger fields that communicate the supersymmetry breaking to the light fields on the visible brane. Supersymmetry breaking arises due to the quantum mechanical zero point fluctuations of the heavy messenger fields. The zero point energy induces a vacuum energy and masses for the supersymmetric massless fields in the visible sector which couple to the non-supersymmetric messenger fields through the gauge fields. Let's do an example where $p = 4$ and $p' = 6$. The messengers will be supersymmetric before we turn on the rotation. Later we will consider rotations. The 4-4 strings are the visible sector. The 6-6 strings are hidden on the probe brane and the 4-6 and 6-4 strings are the supersymmetric messenger fields. We understand that the messenger fields are supersymmetric in the following way: According to the equation for summing up the zero-point energies on the NS string (see Appendix C)

$$E_{NS}^0 = (8 - \nu)(-1/24 - 1/48) + \nu(1/24 + 1/48) \quad (2.17)$$

the vacuum energy for the NS string is zero since ν the number of ND boundary conditions equals four. The vacuum energy of the Ramond sector is always zero by supersymmetry. So the vacuum energies for the NS and the R sector match. Moreover, there are fermionic zero modes that come from the four ND and DN boundary conditions in the NS sector and from four NN and DD boundary conditions in the R sector. Using these four fermionic zero modes we can build $2^{4/2} = 4$ states including the vacuum state, half of which are killed by the GSO projection. Including the oppositely oriented fundamental string there are a total of 4 states from the NS sector and 4 from the R sector. All of these states are fermionic in the 10d space-time, but because the D4-brane and D6-brane break the $SO(9, 1)$ space-time Lorentz group down to $SO(1, 3) \times SO(2)_J \times SO(3)_R$ from the 3+1 point of view the R states are world-volume fermions charged under the 3+1 Lorentz group as well as the $SO(2)_J$ R-symmetry but are scalars under the $SO(3)_R$. We will call these states ψ_q and $\psi_{\tilde{q}}$. The states that come from the NS-string are fermions under the $SO(3)_R$ R-symmetry and scalars under the world-volume Lorentz group. We will call these fields q and \tilde{q} . Together these fields make up a $N = 2$ hypermultiplet, Q and \tilde{Q} . Therefore, the messengers are supersymmetric, and there is no supersymmetry to communicate. Now let us consider a relative rotation of the D4-D6 system: Take the D4-brane to extend in 01236 and the D6-brane to extend in 0123789. Let us now rotate the D6-brane in the 67-plane by an angle θ . If $\theta = \frac{\pi}{2}$, then D6 extends in 0123689. What happens to

the fundamental string during the rotation? Some periodic fermions on the worldsheet become anti-periodic, and hence there won't be as many fermionic zero modes as before. Moreover, since the vacuum energy on the string is the sum of the zero point energies of all the modes on the string (periodic bosons and fermions, anti-periodic bosons and fermions) the rotation will change the vacuum energy as well. Precisely, for $\theta = \frac{\pi}{2}$ $\nu = 2$, equation (2.17) equals $-\frac{1}{4\alpha'}$. Therefore the mass of the NS sector is tachyonic. During the rotation, the mass of q went up by $\frac{\theta}{2\pi\alpha'}$ while the mass of \tilde{q} was lowered by $-\frac{\theta}{2\pi\alpha'}$. The mass of the states ψ_q did not change since the rotation in the 67-plane did not effect the periodic fermions in 2345. Moreover, it is a general property of these rotations that all the massive and massless multiplets preserve

$$Str M^2 = 0 \tag{2.18}$$

as is true of softly broken supersymmetric theories as we saw above in section 2.3 .

All this leads us to conclude that the low energy theory on the intersection of N_c visible D4-branes with N_f hidden D6-branes is a 3+1 $SU(N_c) \times U(1)$ $N = 2$ gauge theory ³ with an massless adjoint hypermultiplet A and B and as we saw above heavy N_f fundamental hypermultiplets playing the role of the messenger fields,

$$\begin{aligned} Q &= q + \theta\psi_q + \theta\theta F_q \\ \tilde{Q} &= \tilde{q} + \theta\tilde{\psi}_q + \theta\theta\tilde{F}_q \end{aligned} \tag{2.19}$$

where q has spin 0 and ψ_q has spin $\frac{1}{2}$. There are many massive modes corresponding to the excited 4-6 open string states. These are massive fundamental fields with spin $J = 1, \frac{3}{2}, 2, \dots$. Turning on a non-zero angle in the 6-7 direction corresponds to turning on a FI term. The Lagangian is

$$\begin{aligned} \mathcal{L}_{N=2} &= \int d^2\theta d^2\bar{\theta} \frac{1}{g_{YM}^2} (\Phi_a^\dagger e^{V_b} \Phi_c f^{abc}) + Q_i^\dagger e^{V_a T_{ij}^a} Q_j + \tilde{Q}_i^\dagger e^{-V_a T_{ij}^a} \tilde{Q}_j + \eta \text{Tr} V \\ &+ \int d^2\theta \frac{1}{g_{YM}^2} W_a^\alpha W_\alpha^a + \int d^2\theta (m Q \tilde{Q} + \lambda \Phi Q \tilde{Q} + \Phi[A, B]) \end{aligned} \tag{2.20}$$

a is now an adjoint valued gauge index and i is a fundamental index. In terms of component fields there is a potential for the q -fields

$$V = |m + \lambda\phi|^2 |q|^2 + |m + \lambda\phi|^2 |\tilde{q}|^2 + g_{YM}^2 (|q|^2 - |\tilde{q}|^2 + \eta)^2 \tag{2.21}$$

³ The D4-brane is of course 4+1 dimensional. We will compactify it later.

The adjoint fields Φ, A , and B are neutral under the diagonal $U(1)$ and therefore do not couple to the FI term, but the fundamental fields do. From (2.21) we see that the mass of q is raised by η while that of \tilde{q} is lowered by η . Higher spin fields that are in the fundamental representation will also be split accordingly. Note that massive higher spin multiplets in the adjoint representation will not be split by the rotation and so supersymmetry is broken only at the loop level for the adjoint fields.

3. Models of String Mediated Supersymmetry breaking.

3.1. Hanany-Witten model with rotated D6-branes: D-term potential, scaling limits, Coulomb branch potential at one loop.

	0	1	2	3	4	5	6	7	8	9
NS5	x	x	x	x	x	x
D4	N	N	N	N	D	D	N	D	D	D
D6	N	N	N	N	D	D	D	N	N	N

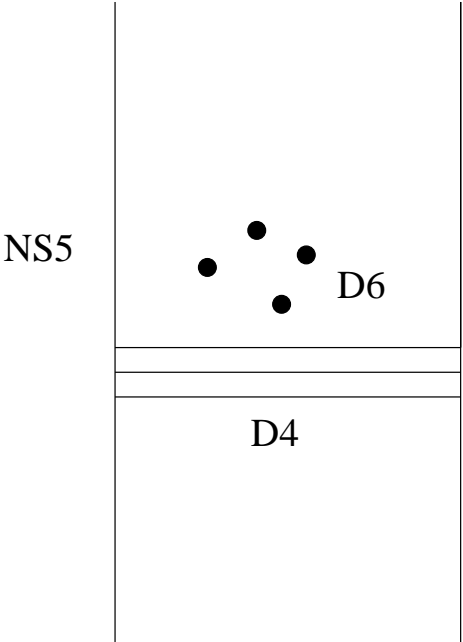

Fig. 1: This is a brane configuration for $N = 2$ super Yang-Mills

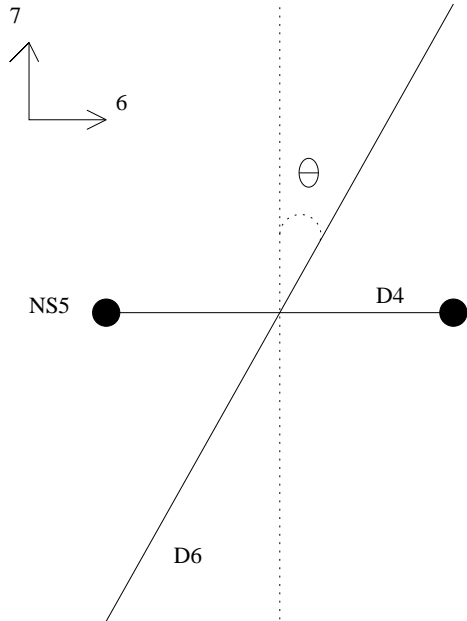

Fig. 2: Rotation of the D6-brane in the 6-7 plane corresponds to a FI-term in the field theory on the brane. The vertical dotted line is not a brane; it is just a reference.

Let us consider NS5 branes in directions 012345, D4 01236, and D6 in directions 0123789 (see fig. 1). The NS-branes serve to restrict the motion of the D4-brane to the 45-directions. In addition the two NS5-branes dimensionally reduce the 5d theory on the D4-brane to four dimensional massless fields plus Kaluza-Klein modes with mass $\frac{1}{L_6}$. On the worldvolume of the branes, the action is (2.20) with the addition of mass terms for two of the three complex adjoint scalar fields

$$W = mA^2 + mB^2. \quad (3.1)$$

The NS5-branes will not participate in the supersymmetry breaking to lowest order. The N_f D6-branes are the probe branes. The global symmetries $SO(1,3) \times U(1)_J \times SU(2)_R$ which correspond to the broken ten dimensional Lorentz symmetry $SO(1,3)_{0123} \times SO(2)_{45} \times SO(3)_{789}$. The fields in (2.20) transform in the way shown in the table below. The $N = 1$ $U(1)_{45+89}$ symmetry is the sum of the $U(1)_{45}$ and the $U(1)_{89}$ and the gaugino λ has been normalized such that it has charge 1 under the $N = 1$ R-symmetry. This is the R-symmetry that survived after the adjoint chiral multiplet gets a mass.

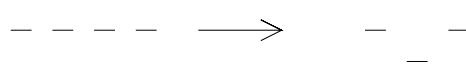

Fig. 3: The spectrum on the left is the supersymmetric spectrum where the fermions ψ_q are degenerate with the bosons q and \tilde{q} . The spectrum on the right corresponds to turning on an angle in the branes and to turning on an FI-term in the field theory. q gets a mass that raises it up while \tilde{q} gets lowered in mass. Note that the sum of the masses doesn't change. Other multiplets charged under the fundamental representation are split in a similar way. Notice that the spectrum looks like a spinor in a magnetic field. This is no coincidence since the scalar fields q are in fact spinor in the R-symmetry group. Moreover, the D-term can be thought of as a magnetic field in those directions. In the brane picture this is clear: rotation T-dualized into magnetic flux.

	$SO(1,3)_{0123}$	$Spin(2)_{45}$	$Spin(2)_{89}$	$Spin(3)_{789}$	$Spin_{45+89}$
ϕ	2	$\frac{1}{2}$	$-\frac{1}{2}$	2	0
λ_α	2	$\frac{1}{2}$	$\frac{1}{2}$	2	1
ϕ	1	1	0	1	1
q	1	0	$\frac{1}{2}$	2	$\frac{1}{2}$
\tilde{q}^*	1	0	$-\frac{1}{2}$	2	$-\frac{1}{2}$
ψ_q	2	$-\frac{1}{2}$	0	1	$-\frac{1}{2}$
D	1	0	0	3	0
F_ϕ	1	0	1	3	1
F_ϕ^*	1	0	-1	3	-1

Note that there are several limits one can take in this Hanany-Witten brane construction. The relevant distances are the separation of the NS5 branes in the x^6 direction, L_6 , and the distance between the D4-branes and the D6-branes, R , in the 45 direction. If the ratio $\frac{R}{L_6} \rightarrow 0$ and $\frac{R}{\sqrt{\alpha'}} \rightarrow \infty$ then we are in the "close supergravity" limit for the messenger fields. Here it is impossible to include massive string states from the 4-6 strings without including so many 5d Kaluza-Klein states that the theory on the D4-brane is essentially five dimensional. This is because in this limit

$$\begin{aligned}
 M_{KK} &= \frac{1}{L_6} \ll \frac{1}{R} \\
 M_{mess} &= \frac{R}{\alpha'} \gg \frac{1}{R}.
 \end{aligned}
 \tag{3.2}$$

Since $M_{mess} \gg M_{KK}$, to keep even the lightest string state we have also to keep many Kaluza-Klein states which propagate in the loop integrals ⁴. Notice that in this limit the D4-D6 system is codimension-2 in 10 dimensions, the potential goes as $\log(R)$ ⁵.

The "far supergravity" limit is relevant for four dimensional physics. This is the limit given by $\frac{R}{L_6} \rightarrow \infty$ and $\frac{R}{\sqrt{\alpha'}} \rightarrow \infty$. In this limit the KK states are heavy compared to the massive string states, and we can cut the theory off before $\frac{1}{L_6}$ and still include many massive string states. In order to do this we demand at least

$$M_{mess} = \frac{R}{\alpha'} = \frac{1}{L_6} = M_{KK} \quad (3.3)$$

which implies that $L_6 \ll \sqrt{\alpha'}$ as well as

$$\begin{aligned} M_{KK} &= \frac{1}{L_6} \gg \frac{1}{R} \\ M_{mess} &= \frac{R}{\alpha'} \gg \frac{1}{R}. \end{aligned} \quad (3.4)$$

Notice in this limit the D4-brane looks like a 3-brane since L_6 is small so the $D4 - D6$ system is essentially codimension-3 in 10d. We saw in section 2.4 using SUGRA that this potential indeed goes like $\frac{1}{R}$. The field theory limit for the messenger fields is when distance R is small compared to $\sqrt{\alpha'}$ but from the bound (3.3) which says that the lightest KK mode is greater than or equal to the lightest messenger field, we find $L_6 \gg \sqrt{\alpha'}$.

In N=2 SQED, turning on both a D-term, η , and a mass term, m , forbids a supersymmetric configuration [18]. For $m < \eta$, the theory is forced onto the Higgs branch as one can see from the potential

$$V = m^2|q|^2 + m^2|\tilde{q}|^2 + g_{YM}^2(|q|^2 - |\tilde{q}|^2 + \eta)^2 \quad (3.5)$$

since \tilde{q} is tachyonic. Since D and F are a $\mathbf{3}$ of the $SU(2)_R$ turning on the D-term breaks this symmetry to $U(1)_R$. The mass has charge 2 under the $U(1)_J$ whose vacuum expectation value breaks the symmetry completely. For non-zero FI-term and zero supersymmetric mass term there is a supersymmetric configuration on the Higgs branch but the Coulomb branch is lifted. One can compare the top of the potential for \tilde{q} with the bottom of the

⁴ In this set up actually Kaluza-Klein modes in the loop integrals cancel to lowest order due to the fact that they are in $N = 4$ multiplets.

⁵ Note that this is the same potential that one obtains from the field theory calculation (2.11). We believe this to be a coincidence and expect that the coefficients do not match.

potential and see that the brane theory reproduces the same difference in vacuum energy as the field theory. To demonstrate this consider that, in the brane theory, the difference in vacuum energy from the unHiggsed to the Higgsed configuration is given by the difference in the length of the D4-brane from the long configuration when it stretches between the two NS5-branes to the shorter configuration where it splits into 2 pieces which stretch between the NS5 and the rotated D6-brane.

$$E^4 = T_{D4}(L - D) \tag{3.6}$$

where

$$T_{D4} = \frac{M_s^5}{g_s} \tag{3.7}$$

is the tension of the D4-brane, L is the length of the brane stretched between in NS 5-branes, and D is the sum of the length of the branes from the NS5 to the D6. They are related by trigonometry

$$D = L \cos \theta = L(1 - \frac{\theta^2}{2} + \dots) \tag{3.8}$$

Where θ is the angle between the D4 and the D6. Plugging (3.8) into (3.6) we find that

$$E^4 = \frac{T_{D4}L\theta^2}{2} \tag{3.9}$$

Now L is related to the Yang-Mills coupling on the D4-brane and θ is related to the FI-term as

$$\begin{aligned} L &= \frac{g_s}{g_{YM}^2 M_s} \\ \theta &= \frac{g_{YM}^2 \eta}{M_s^2} \end{aligned} \tag{3.10}$$

Inserting (3.10) and (3.7) into (3.9) we learn that

$$E^4 = \frac{M_s^5}{g_s} \frac{g_s}{g_{YM}^2 M_s} \frac{g_{YM}^4 \eta^2}{M_s^4} = g_{YM}^2 \eta^2 \tag{3.11}$$

which agrees with the vacuum energy given by equation (3.5).

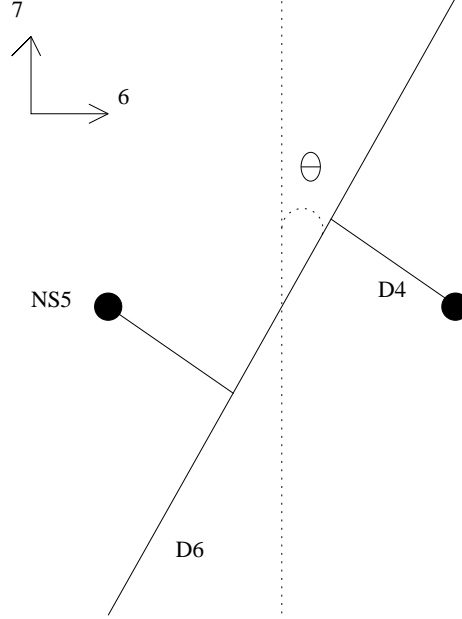

Fig. 4: This minimum length configuration for the D4-brane is split between the D6 and the NS5. For $m = 0$, this is a supersymmetric Higgs branch in the field theory.

Now let us calculate quantum corrections to this model using tree level supergravity. In our $N = 2$ SQCD set-up discussed above with non-zero D-term, $\eta \neq 0$, and non-zero adjoint scalar vacuum expectation value, $\langle \phi \rangle \neq 0$, the Coleman-Weinberg potential can be calculated using channel duality, as explained in section 2.4, and turns out to be,

$$V = -\frac{g_{YM}^4 \eta^2 \sqrt{\alpha'}}{\phi}. \quad (3.12)$$

(3.12) says that the adjoint scalar field ϕ is no longer flat but rather has a minimum at the origin. In the ten dimensional space-time, the interpretation of this potential is that it forces the D4-brane to roll towards the D6-brane in the 45 direction. If we are in the limit where $L_6 \ll \sqrt{\alpha'}$, the D4-brane can be so close to the D6-brane that supergravity is no longer a good approximation; we should use field theory when the lightest mass state due to the 4-6 strings becomes tachyonic. The theory rolls to a supersymmetric Higgs branch when the tachyon condenses [19]. Thus the branes seek out the lowest energy configuration which is the supersymmetric one having zero vacuum energy.

3.2. Another model with the Coulomb branch lifted at one loop; Higgs branch is lifted at

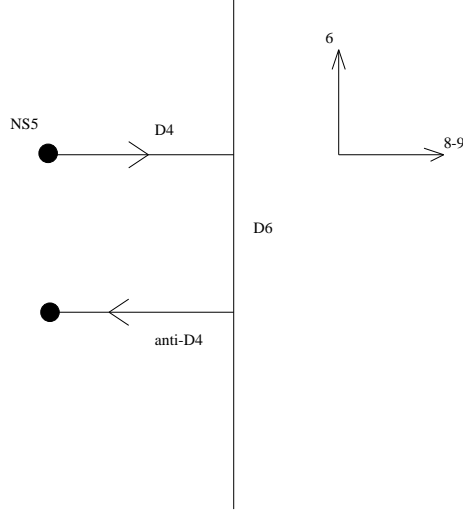

Fig. 5: Here the D4-brane has come so close to the D6-brane that it has split into a D4-brane and an anti-D4-brane. In the field theory on the brane, supersymmetry and gauge symmetry are broken. Note that there are two limits one can take here: If length scales are big compared to the string scale $\sqrt{\alpha'}$, then there is a first order transition. The branes will jump from one configuration to the other more energetically favorable configuration without inducing a tachyon. However, if length scales are small compared to the string scale, then stretched strings will become so light that a tachyon is induced. There is then a second order phase transition from a Coulomb phase into a Higgsed phase.

tree level.

	0	1	2	3	4	5	6	7	8	9
NS5	x	x	x	x	x	x
D4	N	N	N	N	D	D	N	D	D	D
D6	N	N	N	N	D	D	N	D	N	N

Consider an NS5-brane extending along directions 012345, N_c D4-branes extending along directions 01236, N_f D6-branes extending along directions 0123689⁶. Again the $U(1)_J$ symmetry is broken completely by the mass term for the hypermultiplets

$$W = mQ\tilde{Q} \quad (3.13)$$

while the $SU(2)_R$ global symmetry is broken to $U(1)_R$ explicitly by the D-term. The D6-brane can move in directions 457 corresponding to 3 real masses. We can turn on the

⁶ This configuration is topologically inequivalent to the one in section 3.1 since there is a Hanany-Witten transition when the D6-branes cross the NS5.

1 real mass term, ρ , which corresponds to moving the D6-brane away from the D4-brane in the 7-direction. Classically, the q s have a mass given by

$$V = \sum_n (\sqrt{m^2 + \rho^2} + \frac{n}{\alpha'}) \tilde{q}_n q_n \quad (3.14)$$

where n is the mass level of the 4-6 strings. Again quantum mechanically the q fields generate a potential for ϕ . According to the tree level supergravity, this potential has the form

$$V = \frac{|\phi|}{\sqrt{\phi^2 + \rho^2}} \left(1 + \frac{1}{\sqrt{\phi^2 + \rho^2}}\right) \quad (3.15)$$

The adjoint scalars have a mass at $\phi = 0$ when we expand (3.15). At the origin the $U(1)_J$ symmetry is restored. The potential (3.15) has a shape that might be useful in inflationary cosmological scenarios. If the universe rolled along such a potential, then along the flat part for $|\phi| \gg \rho$ the universe would inflate rapidly making it smooth. Then $|\phi| \ll \rho$ is where the universe is now, the uninflating period.

3.3. Higgs branch lifted at one-loop.

	0	1	2	3	4	5	6	7	8	9
NS5	x	x	x	x	x	x
NS'5	x	x	x	x	x	x
D4	N	N	N	N	D	D	N	D	D	D
D6	N	N	N	N	D	D	D	N	N	N
D4'	N	N	N	N	D	D	N	D	D	D

In this set up we consider NS 5 012345, NS'5 012389, N_c D4 01236, N_f D6 0123789, and N'_c anti-D4 in directions 01236. Here it is the D4 and anti-D4, separated in the 45 direction, that break supersymmetry; the $4 - \bar{4}$ strings play the role of non-supersymmetric messengers rather than the 4-6 strings which are massless and have a supersymmetric spectrum classically. The low energy theory on the visible branes is $N = 1$ $SU(N_c)$ SQCD with N_f massless flavors Q and \tilde{Q} as well as N'_c heavy messenger fields P and \tilde{P} with mass $\rho = M_s^2 R$. Motion of the D4-branes broken on the D6-brane in the 789 direction corresponds to the Higgs branch flat directions of this $N = 1$ theory. We can see for $g_{YM}^2 \neq 0$ that the presence of the anti-D4 branes lifts the Higgs branch flat directions

since there is an attractive force between the D4 and anti-D4 brane that inhibits the D4-brane from moving in the 789 direction. We conclude that in the field theory masses for the fundamental scalars are generated in the same way as in the previous section for the adjoint scalars. There is a potential similar to equation (3.15) but for the q fields as a function of the mass of P . The mass for P explicitly breaks

$$V = \frac{|q|}{\sqrt{q^2 + \rho^2}} \left(1 + \frac{1}{\sqrt{q^2 + \rho^2}}\right) \quad (3.16)$$

the $U(1)_{45}$ symmetry but not the $U(1)_{89}$ symmetry. Therefore, the gaugino are protected from getting a mass. The low energy theory is then one of glue, gauginos, and fundamental fermions. One can also have chiral fermions using the mechanism discussed in [20] where the D6-branes split on the NS'5-branes.

There is another phase of the theory when $\frac{L_6}{R} \rightarrow \infty$ where the D4-brane and the anti-D4-brane reconnect along the 7-direction. This is then the diagonal subgroup of the $SU(N_c) \times SU(N'_c)$ gauge theory of the D4 and anti-D4 brane. The force between the D4-brane and the NS5-brane is now mediated not by strings but by membranes⁷.

3.4. Model where gaugino is lifted at one loop.

Consider NS5-branes along 012345, NS'5 branes along 012389, D4-branes along 01236, and D6-branes along 0123679 as represented in the following table.

	0	1	2	3	4	5	6	7	8	9
NS5	x	x	x	x	x	x
NS'5	x	x	x	x	x	x
D4	N	N	N	N	D	D	N	D	D	D
D6	N	N	N	N	D	D	N	N	D	N

Let's position the D6-branes equidistant from the D4-branes in the 48-directions. The low energy theory on the branes is $N = 1$ SQCD with a mass turned on for the flavors

$$W = mQ\tilde{Q} \quad (3.17)$$

⁷ Understanding the second order phase transition here would require "open M-field theory" in analogy with [21].

which breaks the $U(1)_{45}$ symmetry explicitly. Rotation of the D6-brane from 8 into the 6-direction corresponds to turning on an F-term for m which explicitly breaks the $U(1)_{89}$ symmetry. Therefore all global symmetries are broken and there is nothing to protect the gaugino from getting a mass at 1-loop from coupling to the heavy messenger fields Q . The low energy theory is pure glue. Notice that there will be non-field theory interactions that are not visible on the visible brane due to the interaction of the D6-brane with the NS'5 brane. These interactions are not due to fundamental strings and so are non-perturbative in string theory. This appears to be a generic phenomenon when one tries to lift the gauginos in brane models.

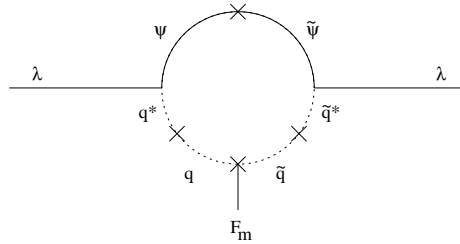

Fig. 6: This is the 1-loop diagram that gives a mass to the gauginos. Notice that both a mass term for the messengers as well as an F-component must be turned on. Turning on a D-term will not lift the gaugino since it won't allow you to draw the diagram in this figure. An F-term for a mass for a hypermultiplet and a D-term for the vector multiplet form a $\mathbf{3}$ of $SU(2)_R$ and are equivalent in theories with $N = 2$ supersymmetry. In $N = 1$ theories the $SU(2)_R$ symmetry is broken and so the F-term and the D-term are no longer equivalent.

3.5. Two loop mediation.

	0	1	2	3	4	5	6	7	8	9
NS5	x	x	x	x	x	x
D4	N	N	N	N	D	D	N	D	D	D
D6	N	N	N	N	N	N	N	D	D	D

We can consider now turning off the Yukawa coupling in the superpotential in (2.20) by setting λ to zero. This breaks the global R-symmetry $SU(1)_J \times SU(2)_R$ to $U(1)_J \times U(1)_R$. This leaves us with $N = 1$ SQCD with an adjoint hypermultiplet softly broken to $N = 0$ by the FI-term. In the limit where the FI-term is string scale, the global symmetry is enhanced to $U(1) \times SU(2)$. The configuration of branes to which this corresponds is NS 5

in directions 012345, N_c D4 in directions 01236, and N_f D6-branes in directions 0123456. The D4-branes and D6-branes are separated by a distance R . When the mass for the fundamental fields is sufficiently large, the lightest modes have the spectrum of a $N = 2$ super Yang-Mills classically.

Lets now calculate quantum corrections to the field theory using gravity. Now because we turned off the Yukawa coupling λ , the expectation value of the adjoint scalar field ϕ is independent of the mass of the fundamental fields, Q , and therefore at zero-th order the potential for the adjoint scalars is still flat but it is shifted by the zero point fluctuations. The calculation is the same as that in section 3.1 but now equation (3.12) has the interpretation as just a 1-loop vacuum energy correction rather than a potential of a field and is given by

$$V_1 = -\frac{g_{YM}^4 \eta^2}{|m| \sqrt{\alpha'}} \quad (3.18)$$

where $m = RM_s^2$ is a parameter rather than a field.

There is a 1-loop beta-function for the adjoint fields due to integrating out the massive W-bosons in $N = 2$ SYM ignoring all the heavy fundamental fields.

$$\frac{1}{g_{ren}^2} = \frac{1}{g_{YM}^2} - 2N_c \log \frac{\phi^2}{M_{cut}^2} \quad (3.19)$$

Because corrections to the FI-term, η^2 in (3.18) depends on the coupling constant there is a term in the potential

$$V_1(\phi) = g_{YM}^2 \eta^2 \left(1 + \frac{g_{YM}^2}{m \sqrt{\alpha'} (1 - 2N_c g_{YM}^2 \log \frac{\phi^2}{M_{cut}^2})} \right) \quad (3.20)$$

Defining $\phi = M_{cut} - \tilde{\phi}$ and expanding (3.20) about small $\tilde{\phi}$, we see that there is a mass term for the adjoint field. Putting the 1-loop effect of the vacuum renormalization together with the 1-loop beta function, we get the 2-loop diagram shown in figure 7 which corresponds to the order g_{YM}^6 effect in the potential (3.20).

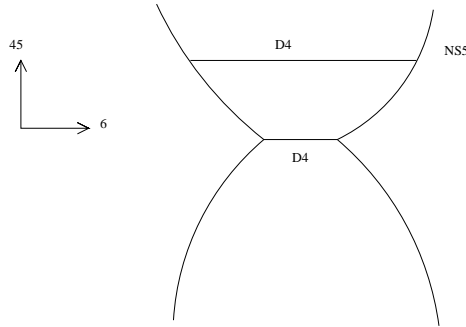

Fig. 8: D4-branes pull on the NS5-branes bending them in the 6-direction. This is the 1-loop beta function for the field theory on the branes.

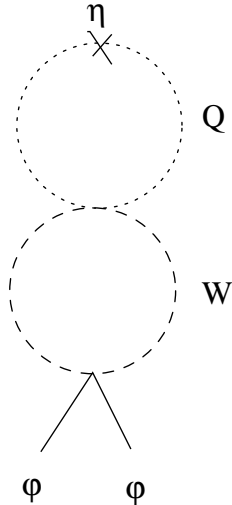

Fig. 7: The adjoint scalar acquires a mass from integrating out the W -bosons. The W -bosons know about supersymmetry breaking because they couple to the heavy messenger fields. This is traditional gauge mediated supersymmetry breaking.

In the brane theory, the effective potential (3.20) has the following interpretation: the 1-loop beta function corresponds to bending of the NS 5-branes in the x^6 direction due to the D4-branes pulling on them. However, the D4-brane is pulled in the x^7 direction towards the D6-brane and so the NS 5-branes should bend in that direction as well. In order for the D4-branes to move in the 45 direction, it must also move in the 7-direction since it is constrained to move along the NS 5-branes. It costs energy for the D4-brane to move away from the gravitational/dilatonic attraction of the D6-branes. We conclude from this that the bending of the NS 5-branes in the 7-direction corresponds to a 2-loop gauge mediated mass term for the adjoint scalar fields. In support of this claim, we point out that the denominator of (3.20) is effectively a renormalization of the mass of the messenger fields as a function of ϕ due to integrating out the massive W -bosons: we can see from figure 7 that the loop part of the diagrams for the mass renormalization of the messengers and the renormalization of the gauge field coupling constant are exactly the same. Indeed we see in the brane construction that due to the bending of the NS 5-brane in the 7-direction, the length of the stretched strings is a function of the 45-coordinates. Moreover, since the bending of the NS 5-brane is a 1-loop effect and the open 4-6 strings are another loop, this agrees with qualitatively with the field theory.

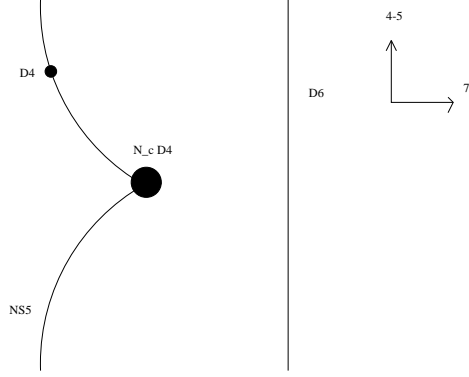

Fig. 9: The D4-branes are pulled towards the D6-brane. The NS5-brane is bent in the 7-direction due to the D4-brane pulling. The small D4-brane is out of equilibrium and wants to move along the NS5-brane towards the large cluster of D4-branes. This corresponds to a 2-loop mass for the adjoint scalar field in field theory on the brane: one loop is the force between the D4 and D6-branes and one loop is due to the brane bending.

Another 1-loop effect is the tadpole correction to the ηD coupling at order g_{YM}^4 where D is the auxiliary field of $N = 1$ superspace. In the brane theory, this has the interpretation as the bending of the D4-brane in the 7-direction, towards the D6-brane. Note that the tension of the D4-brane goes like $\frac{1}{g_s}$ whereas the tension of the NS 5-branes goes like $\frac{1}{g_s^2}$. Therefore, the D4-brane begins to bend at a smaller value of g_s than the NS 5-brane.

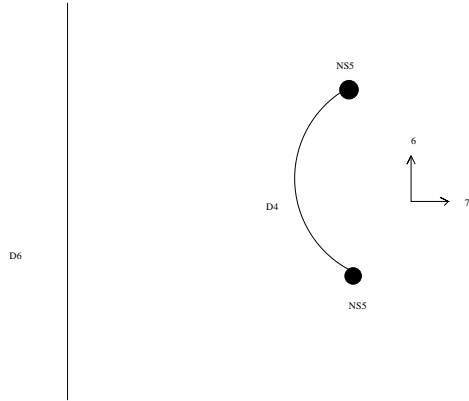

Fig. 10: The D4-brane bends towards the D6-brane because there is an attractive force between them. The bending of the D4-brane has the interpretation as a 1-loop D-term generation: The vacuum energy shifts but no fields get a mass since the adjoints don't couple to the D-term. At this order the massless spectrum is still the same as $N = 2$ SYM. Note that the embedding of the 4-brane here is clearly non-holomorphic because it depends on an odd number of M-theory coordinates: 4, 5, 6, 7 and 11

Notice that although there is a mass term for $\phi^*\phi$ coming from (3.20) the $SU(2)_R$ symmetry has been broken to a diagonal $U(1)_R$ there is not a mass term for the fermions. This is because the fields λ and ψ_ϕ are charged as $(1, 1)$ and $(1, -1)$ respectively under the remaining $U(1)_J \times U(1)_R$ global symmetry. There is no mass term that can be generated that respects these symmetries. Even though the $U(1)_J$ symmetry is broken by instantons to Z_{4N_c} this is still enough symmetry to prevent a mass term. The low energy theory is then a

$$\mathcal{L} = \frac{1}{g_{YM}^2} F_{\mu\nu} F^{\mu\nu} + \bar{\psi} D\psi + \bar{\lambda} D\lambda \quad (3.21)$$

4. Soft and Hard breaking from general rotations.

4.1. General rotations

	0	1	2	3	4	5	6	7	8	9
D4	N	N	N	N	.	.	N	.	.	.
NS5	X	X	X	X	X	X
D6	N	N	N	N	\tilde{N}	$\tilde{\tilde{N}}$.	$\tilde{\tilde{N}}$	$\tilde{\tilde{N}}$	N

Fig. 11: These rotations change the Yukawa couplings between the adjoints and the fundamentals.

	0	1	2	3	4	5	6	7	8	9
D4	N	N	N	N	.	.	N	.	.	.
NS5	X	X	X	X	X	X
NS5'	X	X	X	X	X	\tilde{X}	.	.	\tilde{X}	.

Fig. 12: Both adjoint fermions will have the same mass and rotate under $U(1)_{79}$. There is one real massless adjoint scalar along the 4-direction.

Rotating the 6-brane in directions 67, 68, or 69 corresponds to a real FI D and complex F_ϕ -term. The number of parameters is equal to the number of rotations of a line in four dimensions: $SO(4)/SO(3)$ as is explained in [22]. One can also rotate the D6-brane in 789 and 45. This is the rotation of a 3-plane in 5 spatial dimensions given by $SO(5)/SO(3) \times SO(2)$ which has 6 generators. Notice that we are moding out $SO(5)$ precisely by the R-symmetry group. One can identify the spurions are having charge under the R-symmetry group; they form a 6 dimensional $(2, 3)$ representation under $SO(2) \times SO(3)$. The fact that there are only two gauge invariant operators that one can write for a representation $(2, 3)$ maps nicely into the fact that there are only two invariant rotations of the D6-branes relative to the D4-branes. We can identify these rotations α and θ with the Yukawa coupling λ in the superpotential (2.20) as well as non-holomorphic terms

$$W = \sin \alpha ((1 + \cos \theta)\Phi + (1 - \cos \theta)\Phi^\dagger) Q \tilde{Q}. \quad (4.1)$$

Other operators correspond to field redefinitions of (4.1) such as

$$\mathcal{L} = \xi \int d\theta_\alpha W^\alpha Q \tilde{Q} = \xi \lambda q \tilde{\psi}_q. \quad (4.2)$$

Rotating the D6-brane $\theta = \pi$ in the 75 plane as can be seen in (4.1) takes the usual superpotential coupling

$$\Phi Q \tilde{Q} \rightarrow \Phi^\dagger Q \tilde{Q}. \quad (4.3)$$

In terms of components this eliminates the Yukawa coupling of the adjoint fermion to the squark and quark fields. In fact, the configuration with $\theta = \pi$ was investigated in [23][24] where they found it to have exactly this interpretation in terms of components.

There are also the rotation of the two NS 5-branes with respect to each other as was discussed in [22]. $SO(5)/SO(2) \times SO(3)$ again have 6 generators. This we can identify with the mass term for the adjoint m [25], a charge $(-1, 1)$ under the R-symmetry group $U(1)_{45} \times U(1)_{89}$. The operator

$$W = m \Phi^2 \quad (4.4)$$

breaks the R-symmetry to a single diagonal $U(1)$. Geometrically this will be a linear combination of $U(1)_{45}$ and $U(1)_{89}$. The parameter ζ in the operator

$$\mathcal{L} = \zeta \int d\theta_\alpha W^\alpha \Phi = \zeta \lambda \psi + \zeta D\phi \quad (4.5)$$

has charge $(-1, 0)$. Finally, there is the parameter F_τ which in the $N = 2$ action is correlated with the parameter μ in the operator

$$W = \int d^2\bar{\theta}\mu\Phi^\dagger\Phi = \mu F_\phi^*\phi \quad (4.6)$$

both of which have charge $(-1, -1)$ under the R-symmetry group. Altogether these spurions make a $\mathbf{3}_-$ under the $U(1)_J \times SU(2)_R$. The $\mathbf{3}_+$ comes from the hermitian conjugate operators in the superfield Lagrangian. One can write the non-holomorphic mass term in the superpotential (4.6) in the more geometrically suggestive way

$$W = \sin\beta((1 + \cos\omega)\Phi + (1 - \cos\omega)\Phi^\dagger)\Phi \quad (4.7)$$

where the mass scale is set by the separation between the branes $1/L_6$. The angles β and ω correspond to the two invariant operators one can form from the six dimensional representation $(2, 3)$ of $SO(2) \times SO(3)$. Interestingly, for $\omega = 0$ there is a point with a single massless real adjoint scalar while the other adjoint scalar is massive as is shown in figure 12. At this point both adjoint fermions have the same mass preserving a $U(1)$ global symmetry that can be seen geometrically as a subgroup of the $SO(3)_{789}$. In terms of operators the real scalar can be lifted by turning on ζ in equation (4.5). It is clear that $U(1)_{89}$ will be preserved since ζ is not charged under it. It is easy to show that all of these rotations satisfy $StrM^2 = 0$.

One can consider the rotation of the 2 NS 5-branes from 45 into 6. This is the rotation of a plane in 3 dimensions: $SO(3)/SO(2)$ which has 2 generators. We don't have any interpretation of these to offer. Moving the D6-brane in the 45 direction corresponds to adding a supersymmetric mass term

$$W = \int d^2\theta m Q\tilde{Q} \quad (4.8)$$

	$Spin(2)_{45}$	$Spin(2)_{89}$	$Spin(3)_{789}$	$Spin_{45+89}$
m_Q	1	0	1	1
F_ϕ	0	1	3	1
D	0	0	3	0
F_ϕ^*	0	-1	3	-1
m_ϕ	-1	1	3	0
ζ	-1	0	3	-1
μ	-1	-1	3	-2
F_τ	-1	-1	3	-2
λ	-1	1	3	0
h^*	-1	0	3	-1
ξ	-1	-1	3	-2

4.2. The Dimopoulos-Georgi Theorem.

One of the points of this paper is to show that one cannot just begin with an arbitrary supersymmetric collection of branes, perform a general rotation, and hope to obtain a phenomenologically interesting model. The reason for this is that there will in general be a tachyonic mode coming from the fundamental strings between the rotated branes in order that $StrM^2 = 0$ be satisfied before and after the rotation. Unless this is the Higgs field of the electro-weak interactions, this would be phenomenologically unrealistic. To get realistic models, one must use detached probe branes, as we have been doing in this paper, to break supersymmetry and then mediate it via messenger fields to the supersymmetric visible sector. This way one can have light fields in the visible sector that violate $StrM^2 = 0$. This is not in fact a new result but is the content of a paper by Dimopoulos and Georgi [5].

5. Other Mechanisms for Supersymmetry breaking.

Until now we have broken supersymmetry by rotating the p'-brane relative to the p-brane. Here we will show that rotating the probe brane is equivalent to turning on a flux in the probe brane. For example, consider N_c 4-branes and tilted N_f 6-branes system

at an angle θ . A higher energy excitation of this system is N_c D4s along 01236, N_f D6s along 0123789 and k D6s along 0123689 where k is related to the angle θ [15]. T-dualizing along the 6-direction one gets N_c 3-branes and N_f 7-branes and k D5-branes. Letting the system relax back to its ground state, we find N_c D3-branes and N_f D7s with k units of magnetic flux along its worldvolume. The flux in the 7+1 worldvolume theory points along 67. There is then a coupling to the spinor of $SO(4)_R$ in directions 6789

$$H = F_{MN}\sigma^{MN} \rightarrow \partial_M\phi_N\sigma^{MN} \quad (5.1)$$

For these purposes we can ignore the directions 0123 and focus on 6789 and then the problem becomes the familiar one of a spin 1/2 particle in a magnetic field in four dimensions. The spectrum splits: spin up particle along the B-field have their energy lowered while spin down particles have their energy raised. Because the fermions and bosons are no longer degenerate in mass, supersymmetry is broken. Of course in the string theory models what is relevant are the fermions in the R-symmetry group which are scalars under the 3+1 Lorentz group and the magnetic flux is the flux in the 7+1 flavor fields not the 3+1 color fields. The arrow pointing to the right in equation (5.1) indicates that under T-duality the flavor flux turns into the gradient of a scalar field. Note that the gradient does not have to be constant as was seen in section 3.6. θ , F_{MN} , $\partial_M\phi_N$, are all proportional to the D-term.

6. First order phase transition and tachyonic instabilities

Note that there are two limits one can take in the brane configuration discussed in section 3.1 with NS5 along 012345, D4 along 01236, D6 along 0123456. The NS branes are separated by a length L_6 while the D6 and the D4 are separated by a length R . If length scales are big compared to the string scale $\sqrt{\alpha'}$, then there is a first order transition. As one decreases $\frac{R}{L_6}$, the branes will jump from the configuration where the D4-branes are stretched between the NS5 branes to another more energetically favorable configuration where the D4-branes split into D4 and anti-D4 branes stretched between the NS5s and the D6. A tachyon is never induced during this transition because the fundamental strings never become short enough. The phase transition is from Coulomb to Higgs phase, but instead of having a massive W-boson in the Higgs phase there are a whole tower of closely spaced W-bosons! This is another reason that the "near supergravity" limit is phenomenologically less interesting than the "far supergravity" limit. However, if L_6 is small compared to the string scale, then as we reduce $\frac{R}{L_6}$, stretched strings will become

so light that a tachyon is induced. There is then a second order phase transition from a Coulomb phase into a Higgsed phase. In this limit there will be one W-boson that will have a much lower mass than the tower of states starting at the string scale. To understand this transition one might study open string field theory in analogy with [21]

7. Lessons

It is interesting to note that in the brane models that we considered in section 3 at very short distances in the ten dimensional space-time each brane looks as though it preserves 16 supersymmetries. It is only when one considers all the branes together that supersymmetry is broken. This means that the fundamental theory is in some sense $N = 4$ and one can turn on soft as well as hard breaking terms (from the point of view of $N = 1$) to reduce it to $N = 0$ theories. One lesson from the brane models is that there may be more parameters in the MSSM than was previously considered.

Another lesson from the brane models is that certain perverse couplings from the field theory point of view look very natural when one considers branes. For example, consider flavor D-terms. In the branes one could take a Hanany-Witten model such as the ones in section 3 with D4-branes, NS5-branes, and N_f D6-branes and choose arbitrary angles θ_i where $i = 1, \dots, N_f$ for each of the N_f D6-branes relative to the D4-brane. In the field theory the N_f angles corresponds to having N_f D-terms for each of the flavors. It is a strange operator to consider in field theory, but in the branes it is very natural.

8. Appendix A

8.1. Canonical and string Normalization

Here we give a map in going from the “string normalization” of the field theory action in equation (2.20) and the standard Wess and Bagger normalization [18]. The Wess and Bagger action is

$$\begin{aligned} \mathcal{L}_{\mathcal{N}=\epsilon} = & \int d^2\theta d^2\bar{\theta} (\Phi_a^\dagger e^{g_{YM} V_b} \Phi_c f^{abc} + Q_i^\dagger e^{g_{YM} V_a T_{ij}^a} Q_j + \tilde{Q}_i^\dagger e^{-g_{YM} V_a T_{ij}^a} \tilde{Q}_j + \eta \text{Tr} V) \\ & + \int d^2\theta W_\alpha^\alpha W_\alpha^\alpha + \int d^2\theta (m Q \tilde{Q} + \lambda \Phi Q \tilde{Q} + \Phi[A, B]) \end{aligned} \tag{8.1}$$

where the string-normalization parameters are related to the Wess and Baggar normalization parameters by

$$\begin{aligned}
V &\rightarrow g_{YM}V \\
W_\alpha &\rightarrow g_{YM}W_\alpha \\
\eta &\rightarrow \frac{\eta}{g_{YM}} \\
\Phi &\rightarrow g_{YM}\Phi \\
\lambda &\rightarrow \frac{\lambda}{g_{YM}}
\end{aligned}
\tag{8.2}$$

The arrow points in the direction of the Wess and Baggar normalization. In the WB normalization, one can see from the action (8.1) that the mass of the scalar components of Q and \tilde{Q} is

$$\begin{aligned}
&m^2 + g_{YM}\eta \\
&m^2 - g_{YM}\eta
\end{aligned}
\tag{8.3}$$

and clearly we recover the supersymmetric limit when $g_{YM} \rightarrow 0$.

9. Appendix B

9.1. One color and one flavor.

Here we give rules for counting the number of degrees of freedom on the Higgs branch moduli space using branes. Let us begin with an $N = 2$ $U(1)$ theory with $N_f = 1$. There is one vector multiplet with 8 components and one hypermultiplet with 8 components. Although there is a gauge invariant meson $Q\tilde{Q}$, one cannot give it a vacuum expectation value supersymmetrically because of the D and F-term requirements. We can however turn on a D-term. This gives a vev to the q and breaks the $U(1)$ gauge theory. The massive gauge boson eats the massless scalar. In terms of multiplets: the vector eats the hyper leaving one long multiplet with 16 components. There are no massless degrees of freedom after the Higgsing; the massive long multiplet is a stable non-BPS state since there is nothing for it to decay to.

What is this in terms of branes? This is a simple Hanany-Witten construction with 2 NS 5-branes, one D4-brane, and one D6-brane (see section 3.1). The 4-4 strings give the 8 components of the vector multiplet and the 4-6 strings give the 8 components of the hypermultiplet. Turning on the D-term is like moving one of the NS 5-branes in 789 (or equivalently, rotating the D6 relative to the D4.) The D4-brane splits into two pieces

along the D6-brane separated in the 789 direction. A string can stretch from one D4-brane to the other. We identify that string with the 16 components of the massive non-BPS vector multiplet. In no sense are the ends of the strings charged since the gauge group is completely broken. Although it appears that there are also 4-6 strings, they must carry no massless states. This is consistent with the fact that the D4-branes cannot move once the NS5-branes separate in the 789 direction. To leading order in g_s and α' this is a state non-BPS brane configuration.

9.2. One color and two flavors.

Now let us consider a $N = 2$ theory with a $U(1)$ vector multiplet (8 components) and $N_f = 2$ hypermultiplets ($8 \times 2 = 16$ components). Turning on the D-term gives a mass to the vector multiplet eating one of the hypermultiplets. However there are still 8 massless degrees of freedom coming from the uneaten hypermultiplet. Now we can consider turning on the meson as well in a supersymmetric fashion.

In the brane construction we have 2 NS 5-branes, 1 D4-brane and 2 D6-branes. We separate the NS 5-branes as before in the 789 direction. This is the D-term. We can also now however move the middle piece of the D4-brane between the 2 D6-branes. These are the massless scalar part of the uneaten hypermultiplet. Now the massive non-BPS vector multiplet is not stable since it can decay into the BPS massless hyper.

10. Appendix C

10.1. Open string spectrum between two D-branes.

The first thing we have to understand about the brane configuration is the spectrum of states on the stretched strings between a p-branes and a p'-brane. The spectrum is well known and is given in terms of the string partition function [26]. If the boundary conditions are NN (Neuman on the p-brane -Neuman on the p'-brane) in directions $\mu = 0, \dots, p$ or DD in directions $I = p' + 1, \dots, 9$, then in the NS sector there can be only periodic bosons a_{-n}^μ and a_{-n}^I and anti-periodic fermions $b_{-\frac{n}{2}}^\mu$ and $b_{-\frac{n}{2}}^I$ oscillating in those directions where $n = 0 \cdots \infty$ for periodic oscillators and $n = 1, \dots, \infty$ in the case of anti-periodic oscillators. The ND directions $i = p + 1, \dots, p'$ have antiperiodic bosons $a_{-\frac{n}{2}}^i$ and $a_{-\frac{n}{2}}^i$ and periodic fermions b_{-n}^i and b_{-n}^i . Bosons and fermions get quantized by the usual rules

$$\begin{aligned} [a_n, a_m^\dagger] &= \delta_{n-m} \\ \{b_n, b_m^\dagger\} &= \delta_{n-m} \end{aligned} \tag{10.1}$$

Periodic fermions allow for fermionic zero modes

$$\{b_0^i, b_0^j\} = \delta^{ij} \quad (10.2)$$

Quantizing the zero modes gives rise to $2^{\frac{p'-p}{2}}$ states degenerate with the vacuum. The 2d vacuum energy gets shifted in the NS sector by $-1/24$ by the periodic bosons, $-1/48$ by the antiperiodic fermions, $+1/24$ by the periodic fermions, and $+1/48$ by the anti-periodic bosons. The total vacuum shift in the NS sector is then

$$E_{NS}^0 = (8 - \nu)(-1/24 - 1/48) + \nu(1/24 + 1/48) \quad (10.3)$$

where $\nu = p' - p$ is the number of ND directions. If $\nu < 4$ then there is a tachyon in the NS sector. Defining

$$\begin{aligned} f_1(q) &= q^{\frac{1}{12}}(1 - q^{2n}) \\ f_2(q) &= q^{\frac{-1}{24}}(1 + q^{2n-1}) \\ f_3(q) &= q^{\frac{-1}{24}}(1 - q^{2n-1}) \\ f_4(q) &= q^{\frac{1}{12}}(1 + q^{2n}) \end{aligned} \quad (10.4)$$

The NS partition function is

$$Z_{NS} = 2^{\frac{\nu}{2}} \frac{f_2^{8-\nu} f_4^\nu}{f_1^{8-\nu} f_3^\nu} \quad (10.5)$$

On the Ramond string, the vacuum energy vanishes (due to supersymmetry). The NN and DD sectors have periodic bosons and periodic fermions while the ND sector has anti-periodic bosons and anti-periodic fermions. In the R sector there is $2^{\frac{8-p-p'}{2}}$ states from quantizing the fermionic zero modes in the light cone gauge. The partition function for states on the Ramond string is

$$Z_R = 2^{\frac{8-\nu}{2}} \frac{f_4^{8-\nu} f_2^\nu}{f_1^{8-\nu} f_3^\nu} \quad (10.6)$$

According to the GSO projection, one must project out all states that satisfy

$$(-1)^F = +1 \quad (10.7)$$

For space-time supersymmetry we must have

$$Z_{NS} - Z_R = 0 \quad (10.8)$$

11. Acknowledgements

We would like to thank the Aspen Center for Physics, the Institute for Advanced Studies, Brown University, M.I.T., and the Tata Institute for their hospitality while this work was being completed. We would also like to acknowledge S. Thomas for collaboration on this work as well as N. Evans, C. Johnson, S. Kachru, E. Gimon, K. Intriligator, D. Lowe, S. Ramgoolam, M. Schmaltz, A. Sen, M. Strassler, W. Taylor, S. Trivedi, and B. Zwiebach for useful discussions. We are supported by the D.O.E. under contract number DE-AC03-76SF00515.

References

- [1] N. Arkani-Hamed, S. Dimoulouos, and G. Dvali, Phys.Lett.B429:263-272, 1998;hep-ph/9803315.
- [2] L. Randall and R. Sundrum, “An alternative to compactification,” Phys. Rev. Lett. **83**, 4690 (1999) [hep-th/9906064].
- [3] L. Randall and R. Sundrum, “A large mass hierarchy from a small extra dimension,” Phys. Rev. Lett. **83**, 3370 (1999) [hep-ph/9905221].
- [4] J. Polchinski, “TASI lectures on D-branes,” hep-th/9611050.
- [5] S. Dimopoulos and H. Georgi, Nucl.Phys.B193:150,1981.
- [6] I. Antoniadis, E. Kiritsis and T. N. Tomaras, “A D-brane alternative to unification,” Phys. Lett. **B486**, 186 (2000) [hep-ph/0004214].
- [7] G. Aldazabal, L. E. Ibanez, F. Quevedo and A. M. Uranga, “D-branes at singularities: A bottom-up approach to the string embedding of the standard model,” JHEP**0008**, 002 (2000) [hep-th/0005067].
- [8] J. H. Brodie, “Fractional branes, confinement, and dynamically generated superpotentials,” Nucl. Phys. **B532**, 137 (1998) [hep-th/9803140].
- [9] L. Randall and R. Sundrum, “Out of this world supersymmetry breaking,” Nucl. Phys. **B557**, 79 (1999) [hep-th/9810155].
- [10] M. Schmaltz and W. Skiba, Phys. Rev. D **62**, 095005 (2000) [hep-ph/0001172].
- [11] Z. Chacko and M. A. Luty, “Radion mediated supersymmetry breaking,” hep-ph/0008103.
- [12] E. A. Mirabelli and M. E. Peskin, “Transmission of supersymmetry breaking from a 4-dimensional boundary,” Phys. Rev. D **58**, 065002 (1998) [hep-th/9712214].
- [13] J. Polchinski and P. Pouliot, Phys.Rev.D56:6601-6606,1997; hep-th/9704029.
- [14] M. R. Douglas, D. Kabat, P. Pouliot and S. H. Shenker, “D-branes and short distances in string theory,” Nucl. Phys. **B485**, 85 (1997) [hep-th/9608024].
- [15] W. Taylor, Trieste Lectures, hep-th/9801182.
- [16] J.M. Maldacena, Thesis Princeton University, “Black holes in string theory,” hep-th/9607235.
- [17] S. Coleman and E. Weinberg, Phys.Rev.D7:1888-1910,1973
- [18] J. Wess and J. Bagger, Princeton University Press 1992.
- [19] D. Kutasov and E. Givon, Rev.Mod.Phys. 71 (1999) 983-1084 , hep-th/9802067
- [20] J. H. Brodie and A. Hanany, “Type IIA superstrings, chiral symmetry, and N = 1 4D gauge theory dualities,” Nucl. Phys. **B506**, 157 (1997) [hep-th/9704043].
- [21] A. Sen and B. Zwiebach, hep-th/0002211.
- [22] N. Evans and M. Schwetz, Nucl.Phys.B522:69-81, 1998, hep-th/9708122.
- [23] S. Mukhi and N. Suryanarayana hep-th/0003219.
- [24] S. Mukhi, N.V. Suryanarayana and D. Tong, hep-th/0001066.

- [25] J.L.F. Barbon, Phys. Lett.B402:59-63,1997; hep-th/9703051.
- [26] Books on string theory such as M. Green, J. Schwarz, and E. Witten Cambridge, Uk: Univ. Pr. (1987) and J. Polchinski, Cambridge, Uk: Univ. Pr. (1998)