

# FIRST MEASUREMENTS OF THE FACET COHERENT TERAHERTZ RADIATION SOURCE

Z. Wu, E. Adli, A. Fisher, H. Loos, M. Hogan, SLAC, Menlo Park, CA 94025, USA

## Abstract

The Facility for Accelerator science and Experimental Tests (FACET) at SLAC provides a high charge, high peak current, sub-picosecond bunched electron beam that is ideal for 0.1 to 2 THz radiation generation via coherent transition radiation. This paper presents preliminary characterization of the terahertz pulses generated by the FACET electron beam. The measured THz frequency content spans from 0.25 THz to 2.3 THz and peaks at around 0.5 THz. The radiation has been focused down to a  $4.4 \times 4.8 \text{ mm}^2$  transverse spot with 0.69 mJ collected total energy per pulse. Fitting the energy to the spatiotemporal profile of the THz pulse yields peak e-field amplitude of 1.5 MV/cm.

## INTRODUCTION

Being a long-time underutilized portion of the electromagnetic spectrum, terahertz (100 GHz  $\sim$  10 THz) spectral range is experiencing a renaissance in recent years, with broad interests from chemical and biological imaging, material science, telecommunication, semiconductor and superconductor research, etc. Nevertheless, the paucity of THz sources especially strong THz radiation hinders both its commercial applications and nonlinear processes research. FACET — Facilities for Accelerator science and Experimental Test beams at SLAC — provides 23 GeV electron beam with peak currents of  $\sim 20 \text{ kA}$  that can be focused down to  $100 \mu\text{m}^2$  transversely. Such an intense electron beam, when compressed to sub-picosecond longitudinal bunch length, coherently radiates high intensity EM fields well within THz frequency range via transition radiation. Such radiation is orders of magnitude stronger than those available from laboratory tabletop THz sources, and will enable a wide variety of THz related research opportunities. Together with a description of the FACET beamline and electron beam parameters, this paper will report FACET THz radiation source via coherent transition radiation, calculated photon yield and power spectrum, and preliminary measurement results. A user table has been set up along the THz radiation extraction site, and equipped with various signal diagnostics including THz power detector, Michelson interferometer, sample stages, and sets of motorized optical components. A THz transport line for optical and THz pump-probe experiments outside the accelerator housing is also under construction.

## EXPERIMENT

Originally proposed as a facility to support research on plasma Wakefield acceleration using both electrons and positrons, FACET uses the first two kilometers of the

SLAC linac to produce electron beam with energy in excess of 20 GeV and very small emittance. At Sector 20 in the existing linac tunnel, a new beamline is under construction with a bunch compressor, final focus system and experimental areas appropriate for plasma Wakefield acceleration research. Upstream of the focal point an optical table has been added where THz radiation is extracted and can be utilized for additional diagnostics and user driven THz experiments. Figure 1 below shows the schematic of the FACET beamline [1].

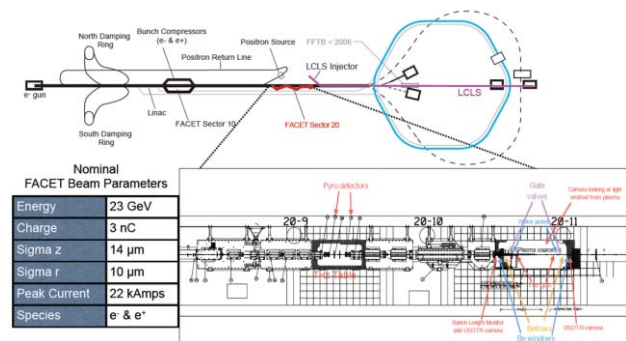

Figure 1: Schematic of the FACET beamline, a zoom-in at the Sector 20 experimental area, and a table of FACET nominal beam parameters.

FACET provides beamline hardware and systems that allows high charge, high peak-current beam operation. The table in Figure 1 lists beam parameters for nominal FACET operation. At full compression, FACET offers  $\sim 3.2 \text{ nC}$  charge per pulse at energy of 23 GeV, with 3% FWHM momentum spread and 10 Hz repetition rate. The bunch length is adjustable from 15  $\mu\text{m}$  to 100  $\mu\text{m}$  (50 fs to  $\sim 300$  fs). Such an intense electron beam can radiate an enormous amount of photons at wavelengths comparable to the bunch length via coherent transition radiation.

## Coherent Transition Radiation

Transition radiation is emitted at the interface when an electron travels into a different media. If the electron beam has longitudinal structure, electrons in the beam will emit coherently at wavelengths comparable to that characteristic length, and total radiation power will scale as the square of the charge number  $N$ . The fact that FACET beam carries  $N = 2 \times 10^{10}$  charges bunched at tens of micron length ensures a high THz photon yield when the beam passes through a foil. A schematic of THz generation by inserting a metallic foil into the beam is shown in Figure 2. The insertion angle is  $45^\circ$  so that the photon emission propagates transversally out of the electron beam trajectory. The foil installed is 1- $\mu\text{m}$  thick Titanium foil spanned over a one-inch circular aperture.

There are two foil insertion cubes on the FACET THz table for double THz extractions.

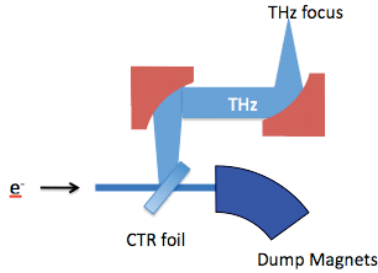

Figure 2: Schematic of thin-foil CTR THz generation, collection and focus.

An in-house code developed at SLAC [2, 3] was used to calculate THz radiation power and spectrum from the coherent transition radiation. The foil is simplified as a perfect electric conductor boundary with unity reflection coefficient over the whole frequency range considered. The electric field for an electron bunch of 3 nC charge, 23 GeV energy, 50 fs bunch length in longitudinal direction, and 10  $\mu\text{m}$  in diameter transversal spot size is calculated and plotted in Figure 3. For this case, the peak current is roughly 27 kAmp and the maximum electric field intensity goes up to  $0.6 \text{ V/\AA}$  in the  $\sim 150 \text{ fs}$  long quasi-half cycle pulse obtained. The power spectrum contains significant content from DC up to 6 THz, and peaks at about 1.2 THz. The total power yield per pulse is 13 mJ.

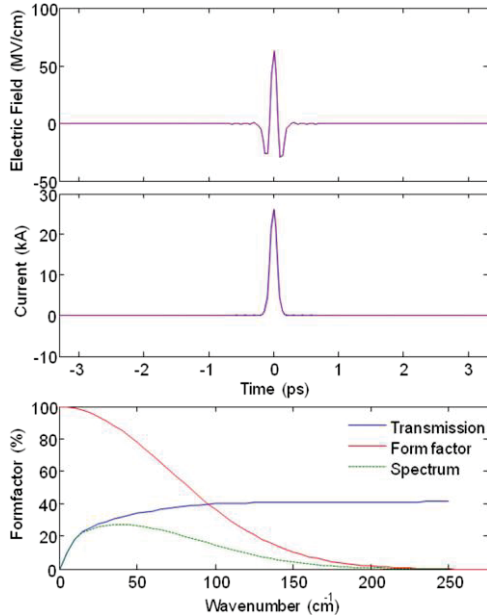

Figure 3: Calculated electron bunch peak current, CTR emission field and power spectrum using FACET beam parameters.

### Preliminary Results

During FACET commissioning over Summer 2011, several optics for THz radiation diagnostics were set up on the THz user table. The top figure in Figure 4 shows

the optical layout, with the THz beam path annotated by pink stripes. The THz radiation exits the beamline vacuum through a silicon window, and is then collimated by an OAP and steered towards the middle of the table (as the inset shows). An insertable OAP can focus the upstream beam to a waist where a 3-axis knife-edge scan measures the spot size. The knife-edge stage also acts as a sample stage for the transmissive exposure of samples to THz radiation. The light is then reimaged onto a joulemeter for a total-energy measurement. The layout at the downstream foil is the same except for the waist-size measurement. When the insertable OAP is removed, a rotating mirror can send either beam along a common path in the middle toward a Michelson interferometer, to measure the power spectrum. The THz beam is split before entering the interferometer to provide a reference readout used to normalize shot-by-shot intensity fluctuations. The optical components are controlled by numerous motors for fully remote operation. A box purged with dry air will cover the whole table to minimize loss from water vapor. The bottom picture shows the upstream half of the table, including the first OAP, the reimaging OAP pairs, the knife-edge, the Gentec-EO total-energy detector, and the rotating mirror sending the THz toward the Michelson interferometer. The InfraTec pyro detector for the downstream beam is also shown on the right.

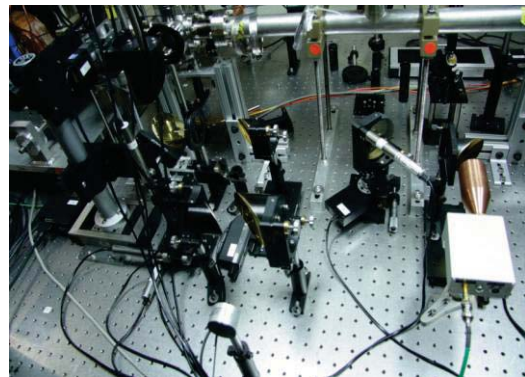
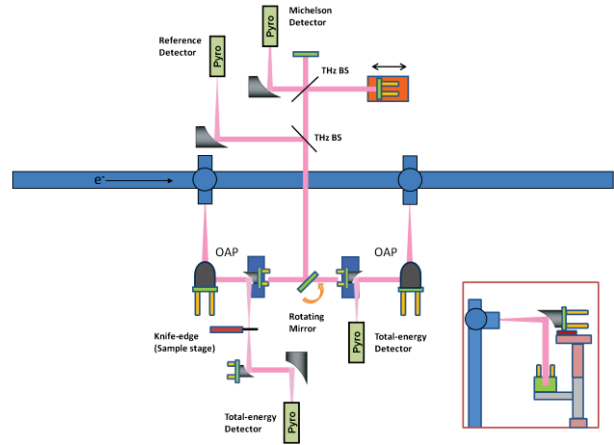

Figure 4: Layout of the THz diagnostic table and image of the current table setup.

Preliminary measurements include the autocorrelation scans at different bunch compressions, the pulse energy readout, and waist-size scans at the focus.

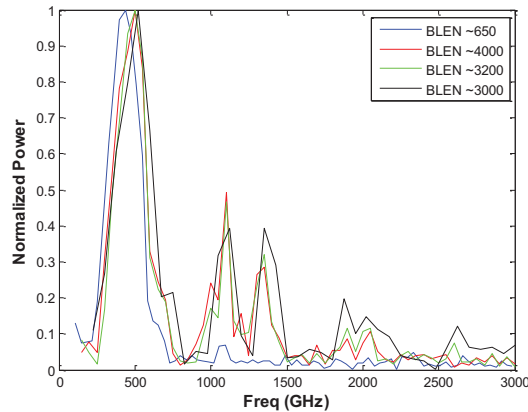

Figure 5: normalized power spectra at different bunch compression.

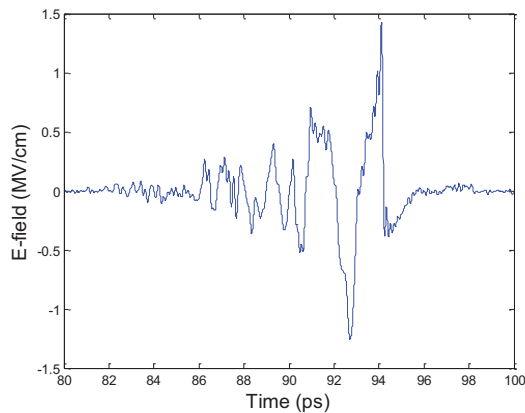

Figure 6: Reconstructed THz waveform using Kramers-Kronig relation.

Figure 5 depicts power spectra measured at different bunch compressions. The pyro-detector of the bunch-length-monitor (BLEN) on the IP table was used as a figure of merit for compression. The highest peak frequency appears on the black curve with the highest BLEN value (the most compression). The spectrum reveals multiple filtering effects. The low-frequency roll-off is due to the apertures of various collecting optics. Water-vapor absorption accounts for local dips. Troughs recurring every  $\sim 750$  GHz correlate with Fabry-Pérot modulation of the coating layer on the InfraTec pyro-detector of the autocorrelator.

Figure 6 plots the reconstructed waveform of the THz pulse using Kramers-Kronig relation [4]. The waveform shows a  $\sim 1$  picosecond long main pulse, followed by ringing tails due to the water vapor lines and notches from the detector response envelope. The knife-edge scans along both transverse directions yield typical Gaussian distributions, and give 2.2 mm by 2.4 mm transverse THz beam radius at its focal point. The Gentec-EO joulemeter

measures 0.69 mJ per-pulse energy. Using these spatial dimensions and the reconstructed temporal profile of the THz pulse, the estimated peak electric-field at the focal point is 1.5 MV/cm, and the peak magnetic-field reaches 0.5 Tesla.

## REFERENCES

- [1] FACET Conceptual Design Report, Sept. 2009.
- [2] H. Loos et al., SLAC-PUB-13395, Aug. 2008.
- [3] J. D. Jackson, *Classical Electrodynamics*, J. Wiley & Sons, New York, 1975.
- [4] O. Grimm and P. Schmuser, "Principles of longitudinal beam diagnostics with coherent radiation," DESY-TESLA FEL 2006-03, April 2006.