

# SLAC Cosmic Ray Telescope Facility

J. Va'vra

SLAC National Accelerator Laboratory, CA, USA

**Abstract** – SLAC does not have a test beam for the HEP detector development at present. We have therefore created a cosmic ray telescope (CRT) facility, which is presently being used to test the FDIRC prototype. We have used it in the past to debug this prototype with the original SLAC electronics before going to the ESA test beam. Presently, it is used to test a new waveform digitizing electronics developed by the University of Hawaii, and we are also planning to incorporate the new Orsay TDC/ADC electronics. As a next step, we plan to put in a full size DIRC bar box with a new focusing optics, and test it together with a final SuperB electronics. The CRT is located in building 121 at SLAC. We anticipate more users to join in the future. This purpose of this note is to provide an introductory manual for newcomers.

## INTRODUCTION

In order to test a Cherenkov ring imaging detector in a cosmic ray telescope (CRT) without a magnetic analysis, one needs a rather thick iron absorber to get hard muons by a range measurement; one also needs a tracking resolution at a level of  $\sim 1$ -2 mrad. We have chosen the iron thickness of  $\sim 48''$  in order to get hard muons of energy larger than  $\sim 1.5$  GeV, and two scintillator hodoscopes to do tracking. In addition, in order to get a reasonable rate, the should be large; in our case the angular tracking acceptance is  $\pm 17^\circ$  &  $\pm 27^\circ$  in two respective directions .

This note is not a description of the ongoing FDIRC prototype [1-3] test with a new electronics, as this will be a subject of the future publication on its own merit. However, I cannot avoid several referrals to this SuperB-related test, as the CRT setup was upgraded for this purpose.

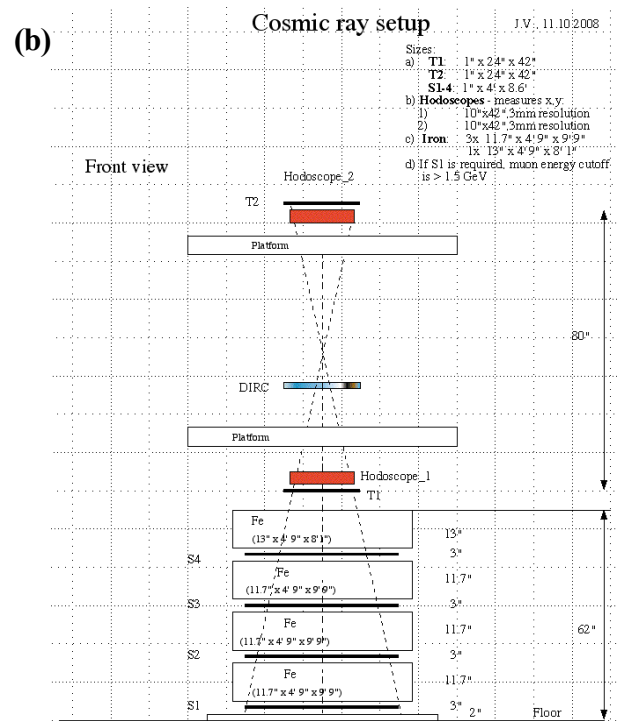
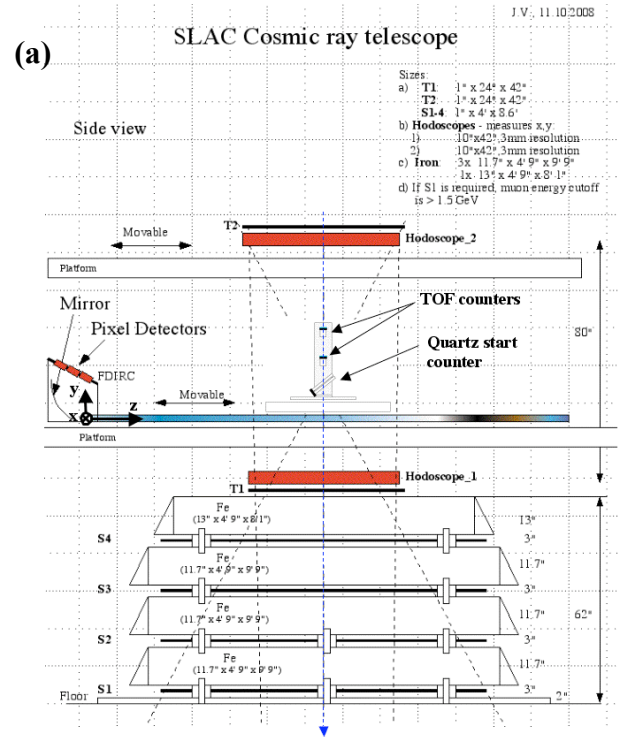
## MECHANICAL DESIGN

### A. Iron stack

Fig.1 shows the design of the CRT. The absorber is made of four segments with an active 1'' thick scintillation counter between each iron<sup>1</sup> segment, which allows more fine energy binning. Fig.1h shows a range in iron as a function of muon energy. One can see that in order to get hard muon tracks ( $> 1.5$  GeV), one needs a very thick absorber.

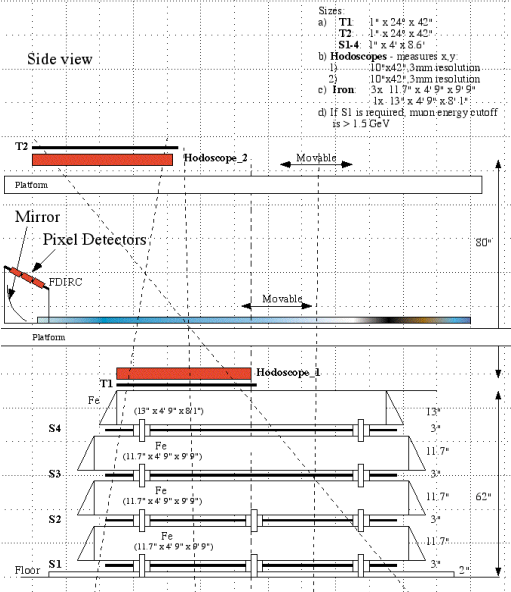
This work supported by the Department of Energy, contract DEAC02-76SF00515

<sup>1</sup> The iron was originally a magnet iron for the TPC experiment at PEP-I.

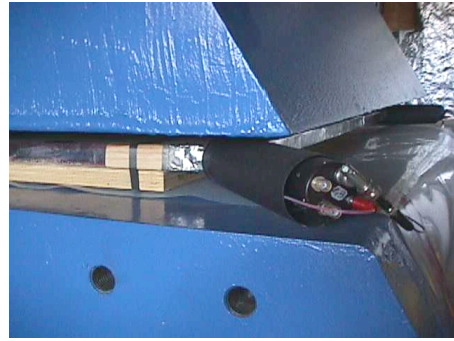


SLAC Cosmic ray telescope

(c)



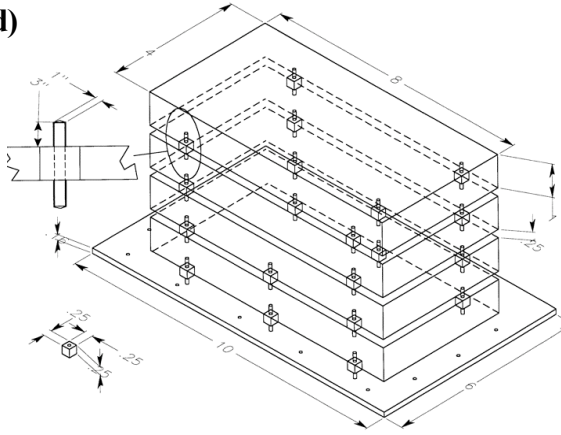
(f)



(g)

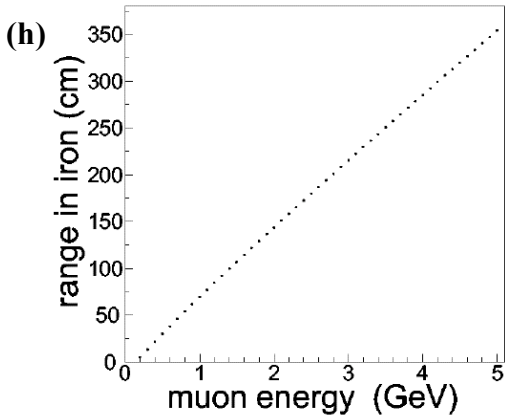


(d)



(e)

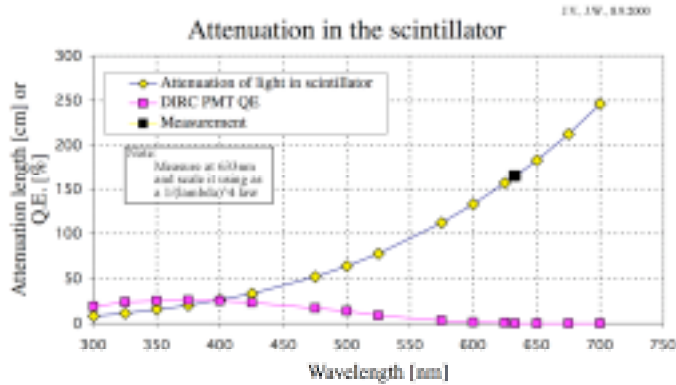




**Fig. 1.** CRT design showing: (a) side view (this also shows the coordinate system used for the FDIRC prototype), (b) front view, (c) a possible extension along z-direction to reach larger muon track dip angles relative to the bar, (d) earthquake safety, (e) view of steel segments and the scintillator layers, (f) detail of one PMT reading one corner of the scintillator, (g) picture of the entire CRT, (h) range in iron as a function of muon energy as calculated by Geant MC program.<sup>2</sup>

### B. Large stack counters

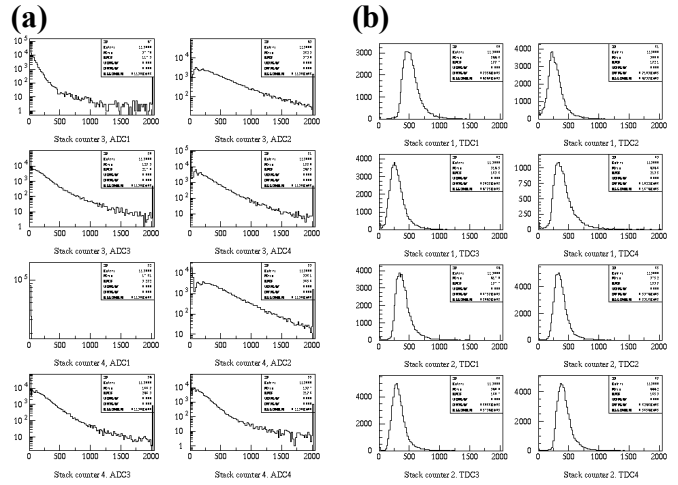
The large area scintillation counters (also called stack counters) were made out of 1-foot wide pieces glued together along the long edges.<sup>3</sup> Fig.2 shows the Bialkali photocathode wavelength acceptance region using a  $1/\lambda^4$  dependence. Because the scintillator transmission is not that good, we decided to detect the light at all four corners of both the stack and trigger counters. Furthermore, the large stack counters have 10x amplifiers to deal with small signals better.



**Fig. 2.** Photon attenuation measurement at 633 nm in the large single-piece stack scintillator counter (theoretical curve assumes a  $1/\lambda^4$  dependence).

<sup>2</sup> The graph “range vs. energy” was provided by G. Varner.

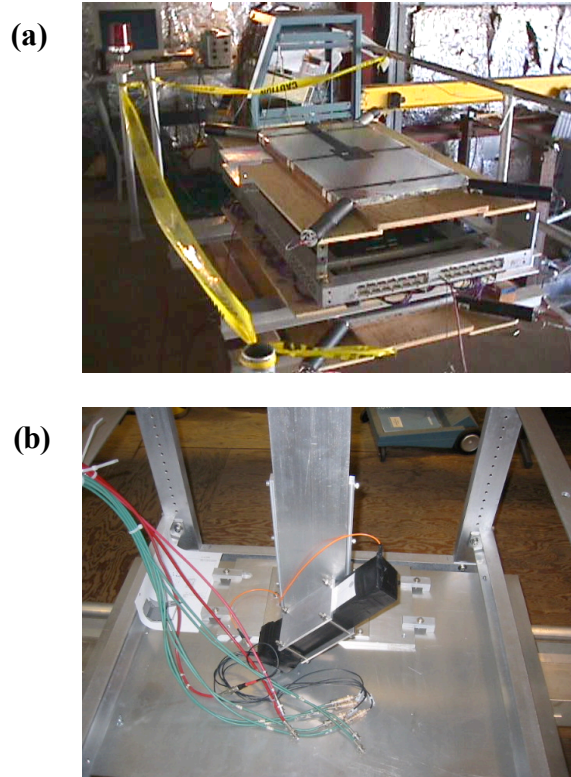
<sup>3</sup> The scintillation material was used originally in TOF counters of the Mark-I experiment at SPEAR, and perhaps, by this time, it does not have the best attenuation length (see Fig.1i for the measurement and expectation).



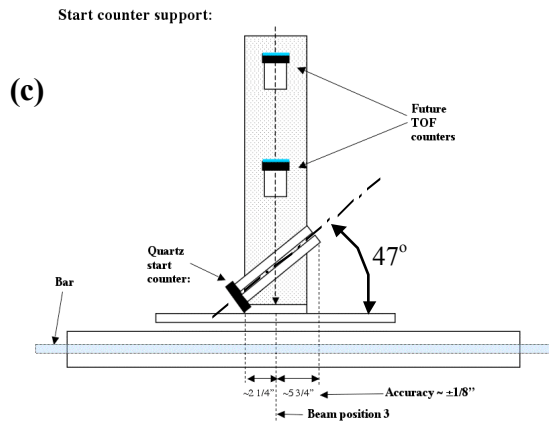
**Fig. 3.** Examples of (a) ADC and (b) TDC distributions in two bottom stack counters S1&S2 (S1 is the very bottom one).

### C. Energy determination by range measurement

Fig.1h shows that the present absorber thickness provides an energy cutoff of  $\sim 1.5 \text{ GeV}$ <sup>4</sup>, if one requires that the very bottom scintillator fires. For smaller required absorber thickness, one can bin the muon energy in steps of  $\sim 350 \text{ MeV}$ . This is accomplished by making appropriate cuts on ADCs or TDCs hits in the stack counters. Fig.3 shows examples of such distributions.



<sup>4</sup> There is a room to increase the absorber thickness, if required, by adding an additional  $\sim 12$ ” of lead under the platform (see Fig.1a). This would provide a muon energy cutoff of  $\sim 2.3 \text{ GeV}$ .

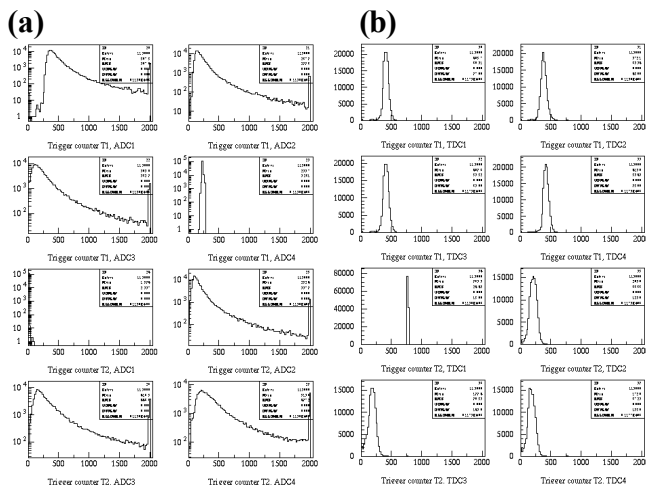


**Fig. 4.** CRT trigger counters: (a) large area trigger counters T1 & T2, (b) small quartz counter (this is our time-reference  $t_0$ ), and (c) details of the present start counter support.

#### D. Trigger counters

The CRT has two large trigger counters of 24" x 48" size. The trigger counters were made using the same method as the stack counters, i.e., gluing one foot-wide scintillators along the long length. Each counter has four Photonis Quantacon PMTs located at each corner as one can see in Fig.4a. Fig.5 shows the ADC and TDC distributions in the large trigger counters.

For work with the Focusing DIRC prototype one needs to determine  $t_0$  time more precisely in order to be able to do the chromatic corrections by timing. For this purpose we use a quartz counter,<sup>5</sup> which is a double quartz bar coupled to a 4-pixel Photonis MCP-PMT. Figs.3b&c show the counter and its mechanical support in CRT. The quartz bars are rotated by  $\sim 47^\circ$  to provide a direct Cherenkov light.<sup>6</sup>



**Fig. 5.** Examples of (a) ADC and (b) TDC distributions in two trigger counters. The trigger counter PMT T2\_1 is used

<sup>5</sup> This counter achieved a 42 ps resolution in the ESA test beam [1-3].

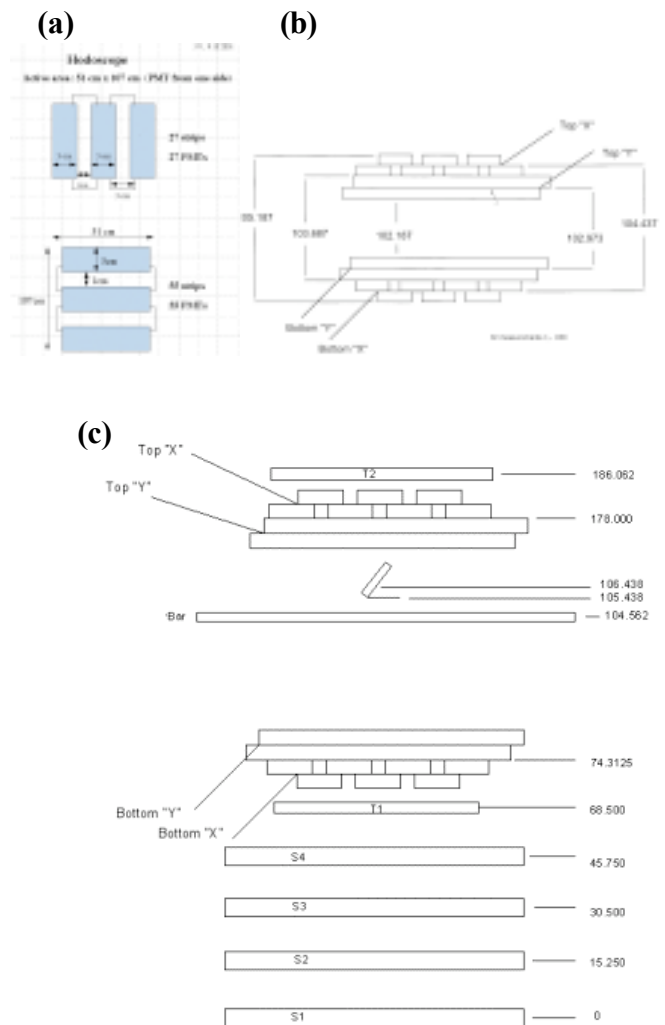
<sup>6</sup> In future, when CRT will have the full size DIRC bar box with a new focusing optics, the quartz start counter will have to be changed. For example, it can run across the entire bar box width [4].

for the reference time and therefore the TDC 1 spectrum is very narrow. The ADC T1\_4 does not seem to work properly.

It is useful to mention the present trigger rates for the following logical conditions: (a) T1\*T2\*Qtz counter  $\sim 11$ -12k/day, and (b) T1\*T2\*S1\*Qtz counter  $\sim 5$ -6k/day. The DAQ system is presently triggered with T1\*T2\*Qtz counter coincidence to allow stack energy binning; however, in future one may restrict it to a harder muon trigger condition. This trigger is also used as an external PiLas<sup>7</sup> laser trigger, which is used to monitor the detectors in the FDIRC prototype.

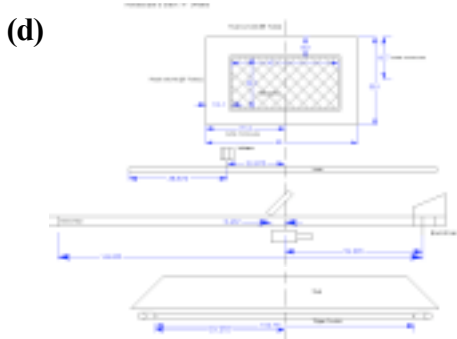
#### E. Tracking with hodoscope counters

We use a scintillation hodoscope developed originally for some ESA experiments.<sup>8</sup> Its conceptual design is shown on Figs.6a&b. The hodoscope's y-offsets and a relationship to the trigger and stack counters are shown on Fig.6c, and its x&z-offsets and a relationship to the bar and stack are shown on Fig.6d. The top and bottom hodoscopes were separated by a distance so that the tracking resolution is close to 1 mrad.



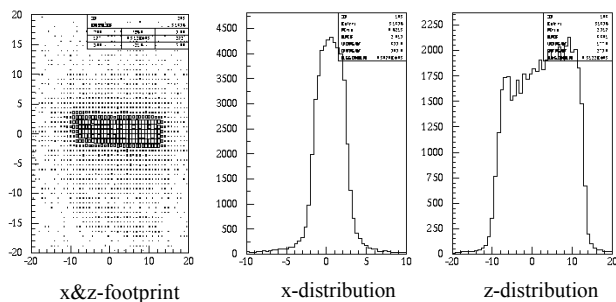
<sup>7</sup> PiLas is a laser diode made by Advanced Lase Diode Systems A.L.S. GmbH, Berlin, Germany.

<sup>8</sup> The hodoscope information came from P. Bosted.



**Fig. 6.** Hodoscope scintillator strip design in (a) x-z plane, and in (b) y-direction, (c) height offsets of all CRT scintillators, and (d) some x&z offsets relative to bar, iron, and stack counters.

Fig.7 shows an example of the quartz counter footprint,<sup>9</sup> obtained with the CRT tracking code.<sup>10</sup>



**Fig. 7.** An example of the CRT tracking with the hodoscopes, which shows the quartz counter footprint in x&z plane.

## ELECTRONICS

### A. CRT electronics

The portion of the electronics rack located on the platform next to the tested detector. It has NIM bins with the trigger logic (see Fig.7a), hodoscope discriminators (see Fig.7b), some essential storage scope monitoring (see Fig.7c), trigger counting scalers and some HV power supplies for the critical FDIRC detectors.

Most of the electronics is located in the counting house. It contains the micro-PC, micro-crate, CAMAC crates, NIM bins and HV power supplies and the HV distribution boxes (see Fig.7d&e).

The Appendix shows tables of labels for all CRT connections, including the present list of known dead channels.

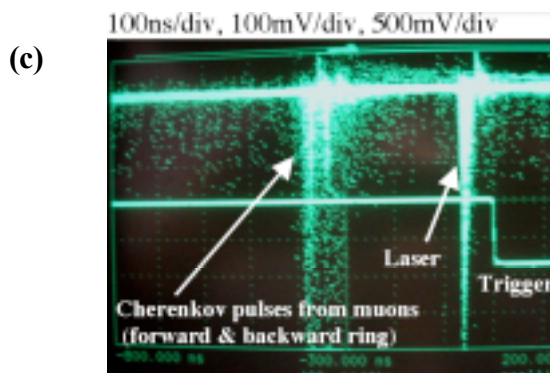
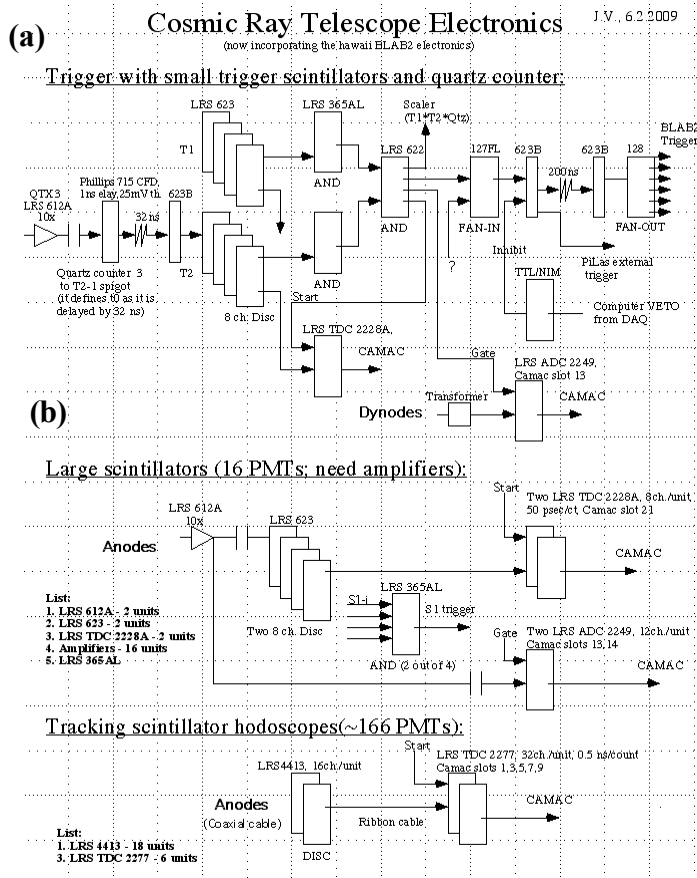
It is assumed that the device-dependent electronics is brought in by the users. An example is the waveform digitizing electronics made by the University of Hawaii.<sup>11</sup>

<sup>9</sup> An example of data analysis was made by the author of this note. It is PAW-based software called `crt_analysis.f`. All plots in this paper were done by this program.

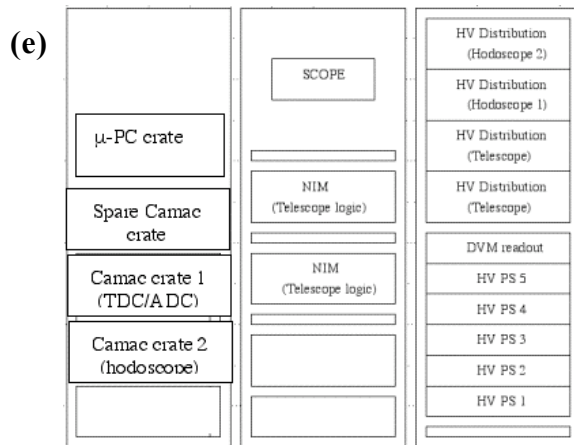
<sup>10</sup> The hodoscope-based tracking code was written by S. Kononov during his visit from the Novosibirsk HEP Institute. It is still being used, however, it runs with a different coordinate system than the FDIRC prototype.

<sup>11</sup> G. Varner, K. Nishimura, and L. Ruckman..

Similarly, Orsay group<sup>12</sup> will bring their TDC/ADC electronics. There are two ways to enter the DAQ system: (a) either make a fiber link from the micro-PC crate, as the Hawaii people did, or (b) make the interface via the CAMAC. Probably the easiest way, at least from a software point of view, is to provide an interface to the CAMAC.



<sup>12</sup> D. Breton, Ch. Beigbeder, and others.



Camac crate #1:

Camac crate #2:

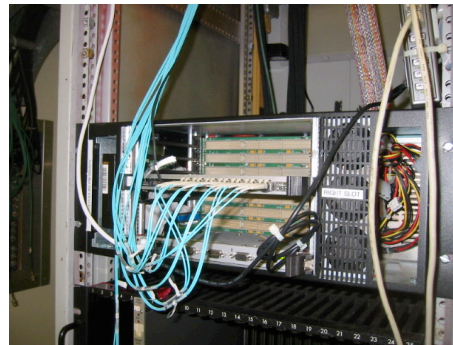


**Fig. 7.** (a) The present CRT trigger electronics used for the FDIRC prototype tests. The time reference is derived from the quartz counter, pad 3. (b) Large stack counter and hodoscope counter CAMAC connections. (c) An example of monitoring of the data taking status with the FDIRC prototype: forward & backward Cherenkov rings from a single quartz bar for tracks which are predominantly perpendicular, and the laser monitoring signal. The laser is using an external trigger, driven by the CRT trigger. (d) The electronics in the counting house, where most of the CRT electronics is located. (e) Electronics layout in the counting house. (f) Picture shows that there is still room available for some modules in Camac crates 1&2.

### B. DAQ system

The DAQ system went through several evolution steps. While the initial scheme<sup>13</sup> served us well to debug the FDIRC prototype with its original SLAC electronics before the ESA beam tests, it was not anymore suitable for the Hawaii waveform digitizing tests, which we are doing presently.<sup>14</sup> Therefore we switched into a micro-PC<sup>15</sup> based DAQ system

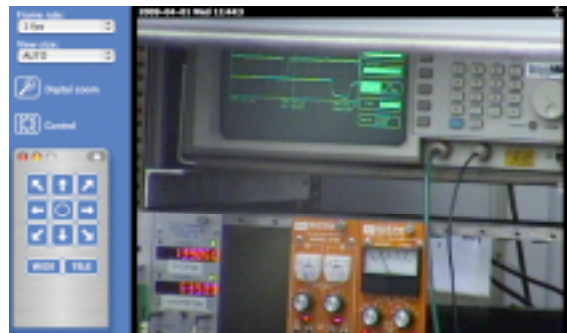
(see Fig.8), which is proven reliable scheme used in the industry, suitable for remote applications requiring small oversight. The micro-PC communicates with two CAMAC crates, dedicated to the CRT detector readout, via the Wiener CC-USB Camac controllers. We suggest that a future user communicates with the DAQ system via a CAMAC crate.<sup>16</sup>



**Fig. 8.** The system is presently using the micro-PC to control the DAQ. Only two slots are occupied at present.

### C. Internet-based remote monitoring

We have installed a SONY camera, which allows a remote web-based monitoring. Figure 8 shows an example of such monitoring: raw PMT pulses from the FDIRC prototype, scalars showing trigger count, and a HV PS status on some FDIRC prototype detectors. This turned out to be very useful feature as one can do this from office.



**Fig. 8.** CRT remote monitoring using the SONY web camera.

## CONCLUSION

Clearly, this note is far from complete to give justice to all details, but I thought it is nevertheless a useful document for newcomers, if they want to use this facility. I tried to gather all important issues from my log book. I hope the CRT facility will be busy in 2010 on the SuperB R&D development.

<sup>13</sup> The original DAQ software was created by T. Hadig.

<sup>14</sup> The present DAQ software was created by K. Nishimura in 2009, University of Hawaii.

<sup>15</sup> cPB4712 2GHz Dual Core LV Xeon cPCI Node made by the Diversified Technologies. The system was contributed by the University of Hawaii. For more hardware information contact G. Varner and L. Ruckman.

<sup>16</sup> The same DAQ system is going to be used for the scanning setup, where we plan to test a detail behavior of chosen photon detectors and electronics for FDIRC detector at SuperB..

## ACKNOWLEDGEMENT

I would like to thanks Matt McCulloch and Robert Reif for meachical construction of the telescope, and all updates we have done since.

## REFERENCES

- [1] J.F. Benitez, I. Bedajane, D.W.G.S. Leith, G. Mazaheri, B. Ratcliff, K. Suzuki, J. Schwiening, J. Uher and J. Va'vra, "Development of a Focusing DIRC," IEEE Nucl.Sci, Conference records, October 29, 2006, and SLAC-PUB-12236, 2006
- [2] J. Va'vra, J.F. Benitez, I. Bedajane, D.W.G.S. Leith, G. Mazaheri, B. Ratcliff, K. Suzuki, J. Schwiening, and J. Uher, "The Focusing DIRC – the first RICH detector to correct the chromatic error by timing," presented at Vienna conference on Instrumentation, Feb. 2007, and SLAC-PUB-12803, 2007.
- [3] J.F. Benitez, I. Bedajane, D.W.G.S. Leith, G. Mazaheri, L.L.Ruckman, B. Ratcliff, K. Suzuki, J. Schwiening, J. Uher, G.S. Varner, and J. Va'vra, "Status of the Fast Focusing DIRC (FDIRC)," presented at Trieste RICH conference, Oct. 2007, to be published in Nucl. Instr.&Meth. A595(2008)104-107.
- [4] J. Va'vra, "Focusing DIRC design for Super B," SLAC-PUB-13763, 2009., and LDRD proposal, SLAC, 4.20.2009

## APPENDIX

The following tables show the cabling scheme of the trigger, stack, hodoscope counters, and labels for the CAMAC wiring:

### (a) Trigger and stack counters:

Large SLAC Cosmic Ray telescope

Counters in the stack:		Labeling outside counting house				Labeling inside counting house				Final labeling scheme		PS
#	Description	PMT #	HV cable #	Anode cable #	Dynode cable #	Anode cable	Dynode cable	PMT HV [kV]	Anode cable #	Dynode cable #	Voltage [kV]	
1	Bottom large	1	1	17	AS1	DS1	-1.91	AS1-1	DS1-1	-2.4		
		2	2	18	AS2	DS2	-1.89	AS1-2	DS1-2	-2.4		
		3	3	19	AS3	DS3	-1.98	AS1-3	DS1-3	-2.4		
		4	4	20	AS4	DS4	-2.03	AS1-4	DS1-4	-2.4		
2	Next up	1	5	21	AS5	DS5	-1.96	AS2-1	DS2-1	-2.4		
		2	6	22	AS6	DS6	-1.98	AS2-2	DS2-2	-2.4		
		3	7	23	AS7	DS7	-1.98	AS2-3	DS2-3	-2.4		
		4	8	24	AS8	DS8	-1.85	AS2-4	DS2-4	-2.4		
3	Next up	1	9	25	AS9	DS9	-2.11	AS3-1	DS3-1	-2.4		
		2	10	26	AS10	DS10	-1.93	AS3-2	DS3-2	-2.4		
		3	11	27	AS11	DS11	-1.97	AS3-3	DS3-3	-2.4		
		4	12	28	AS12	DS12	-2.1	AS3-4	DS3-4	-2.4		
4	Top in the stack	1	13	29	AS13	DS13	-1.89	AS4-1	DS4-1	-2.2		
		2	14	30	AS14	DS14	-1.97	AS4-2	DS4-2	-2.2		
		3	15	31	AS15	DS15	-1.97	AS4-3	DS4-3	-2.2		
		4	16	32	AS16	DS16	-2.01	AS4-4	DS4-4	-2.2		
Counters in the trigger:												
5	Trigger bottom	1	17	AT1-1	33	DT1	-2.11	AT1-1	DT1-1	-2.2		
		2	18		34	DT2	-2.19	AT1-2	DT1-2	-2.2		
		3	19		35	DT3	-1.95	AT1-3	DT1-3	-2.2		
		4	20		36	DT4	-1.9	AT1-4	DT1-4	-2.2		
6	Trigger top	1	21		37	DT5	-1.96	AT2-1	DT2-1	-2.2		
		2	22		38	DT6	-2.06	AT2-2	DT2-2	-2.2		
		3	23		39	DT7	-1.95	AT2-3	DT2-3	-2.2		
		4	24		40	DT8	-1.95	AT2-4	DT2-4	-2.2		
Hodoscopes:												
1	Bottom		41								-1	
2	Top		42								-1	

### (b) Hodoscope counters:

#	Description	Cable #	Discriminator Slot number	TDC 2277 Slot number	TDC cables label
1	Bottom	1TX1-16	1	1	A1
1	Bottom	1TX17-32	3	1	A3
1	Bottom	1TX33-48	5	3	A4
1	Bottom	1TX49-1TY8	7	3	A5
1	Bottom	1TY9-24	9	5	A6
1	Bottom	1TY25-27	11	5	A7
2	Top	2TX1-16	13	7	A8
2	Top	2TX17-32	15	7	C7
2	Top	2TX33-48	17	9	C2
2	Top	2TX49-1TY8	19	9	C3
2	Top	2TY9-24	21	11	C4
2	Top	2TY25-27	23	11	C5

#	Description	HV feed cable #	Cable # x or y coord.	Feed voltages (after a pot.)	PS Voltage
1	Bottom	H1	1TX1-15	-0.94	-0.95
1	Bottom	H2	1TX16-27	-0.94	-0.95
1	Bottom	H3	1TX28-42	-0.94	-0.95
1	Bottom	H4	1TX43-1TX54	-0.94	-0.95
1	Bottom	H5	1TY1-16	-0.94	-0.95
1	Bottom	H6	1TY17-27	-0.94	-0.95
2	Top	H7	2TX1-16	-0.94	-0.95
2	Top	H13	2TX1-20	-0.94	-0.95
2	Top	H14	2TX22-36	-0.94	-0.95
2	Top	H15	2TX37-1TX55	-0.94	-0.95
2	Top	H16	2TY1-12	-0.94	-0.95
2	Top	H17	2TY13-27	-0.94	-0.95

### (d) Hodoscope counter dead channels:

Lemo label	Disc slot	TDC slot	Connector	TDC channel	Present (3_17_09) diagnosis	Original diagnosis (2001)
1TX3	1	1	A1	3	See signal in data cannot get to LEMO connector	Dead PMT
1TX29	3	1	A1	29	Dead PMT, no signal in front of DISC, no data	Dead PMT
1TX55	7	5	A5	23	See signal in front of DISC, do not have data	Dead PMT
1TY13	9	5	A6	6	See signal in front of DISC, see data	Dead PMT
1TY11 (?)	9	5	A6	3	see data	Bad DISC
1TX56					No signal in front of DISC	
2TY12	21	11	C4	4	No signal in front of DISC, no data	Dead PMT
2TY15	21	11	C4	7	See signal in front of DISC, see data	Dead PMT
2TX32	15	7	C7	32	See data	Bad DISC

Note: These channels will be repaired before a final FDIRC test starts.

### (e) CAMAC connections:

Top CAMAC crate #1											
Unit	Module	Slot	Channel	Channel	Channel	Channel	Channel	Channel	Channel	Channel	Channel
Hodoscope											
Trigger											
Miscellaneous											
Bottom CAMAC crate #2											
Hodoscope											
Trigger											
Miscellaneous											
Input/output register model IR-1											
Transic D/A 3016											

### (f) CAMAC scaler connections:

LeCroy Scaler 2551				
Cable label	Scaler #	CAMAC Slot	Channel	CAMAC crate
Anode AS1-1	1	16	0	1
Anode AS1-2	1	16	1	1
Anode AS1-3	1	16	2	1
Anode AS1-4	1	16	3	1
Anode AS2-1	1	16	4	1
Anode AS2-2	1	16	5	1
Anode AS2-3	1	16	6	1
Anode AS2-4	1	16	7	1
Anode AS3-1	1	16	8	1
Anode AS3-2	1	16	9	1
Anode AS3-3	1	16	10	1
Anode AS3-4	1	16	11	1
Anode AS4-1	2	17	0	1
Anode AS4-2	2	17	1	1
Anode AS4-3	2	17	2	1
Anode AS4-4	2	17	3	1