

## DEVELOPMENT OF A 10 MW SHEET BEAM KLYSTRON FOR THE ILC\*

D. Sprehn, E. Jongewaard, A. Haase, A. Jensen, D. Martin, SLAC National Accelerator Laboratory,  
 Menlo Park, CA 94020, U.S.A.  
 A. Burke, SAIC, Sunnyvale, CA 95110, U.S.A.

### Abstract

SLAC is developing a 10 MW, 5 Hz, 1.6 ms, L-band (1.3 GHz) Sheet-Beam Klystron as a less expensive and more compact alternative to the ILC baseline Multiple-Beam Klystron. The Klystron is intended as a plug-compatible device of the same beam current and operating voltage as existing Multiple-Beam Klystrons. At this time, a beam tester has been constructed and currently is in test. The beam tester includes an intercepting cup for making beam quality measurements of the 130 A, 40-to-1 aspect ratio beam. Measurements will be made of the electrostatic beam and of the beam after transporting through a drift tube and magnetic focusing system. General theory of operation, design trade-offs, and manufacturing considerations of both the beam tester and klystron will be discussed.

### INTRODUCTION

Sheet-Beam Klystrons (SBK) have gained considerable attention lately and have been the subject of application and simulation studies at frequencies ranging from GHz to THz, and from power levels from Watts to multi-megawatts. Much of this work is focused on the beam formation and transport as this is the most difficult aspect of an SBK. The attractiveness of an SBK for use as RF sources derives from: the reduced energy and thermal densities due to increased surface areas; the reduced current densities possible as the beam becomes wider; the reduced magnetic field, cathode loading and reduction of some instabilities resulting from the reduced current density; and, the potential for lower device cost.

At low power, one may choose planar geometry such as an SBK over that of cylindrical geometry simply because it may lend itself to fabrication methods akin to those used in the semiconductor industry and therefore be easier or cheaper to construct, or even made possible to manufacture at some elevated frequency where features may be too small for conventional methods. At high powers one may choose planar geometry because of one or more of the possible advantages listed earlier. For a plug-compatible alternative for the ILC the reasoning has been mainly argued on the basis of cost. This cost may be one of manufacture but may also include true life-cycle issues if the resulting device can be shown to degrade at a slower rate than alternative devices due to lower power densities or simpler construction.

There are difficulties involved in an SBK design that are not present in symmetrical devices and are present, to a much lesser degree, in Multiple-Beam Klystrons (MBK). The design is inherently 3-dimensional (3D) as opposed to having some components of cylindrical symmetry. A 3D structure is of course more difficult to

analyze, and design work which relies on simulation codes may have to deal with the increased computing power required by taking some liberties. The gun formation and beam transport with and without bunching are the major considerations. For instance, a 3D PIC code with the complete klystron geometry (except the gun), suitable mesh and beam representation may take years to simulate a single 1.6 ms pulse. Obviously this is not practical and so simulation times are much reduced as steady state is reached in  $\sim 100$  ns, but the possibility of oscillations must therefore be taken care of separately by other means once a transport solution is found.

The SBK design was concentrated on achieving a plug-compatible device. The design has a single collector, an output structure with two windows, 6 cavities, a single cathode and ceramic seal as seen in Fig. 1. In the view a quarter-section of the 256 cm long device has been cutaway. The Periodic Cusp Magnet (PCM) focusing scheme discussed later has pole pieces that fit between the cavities with a common flux return plate.

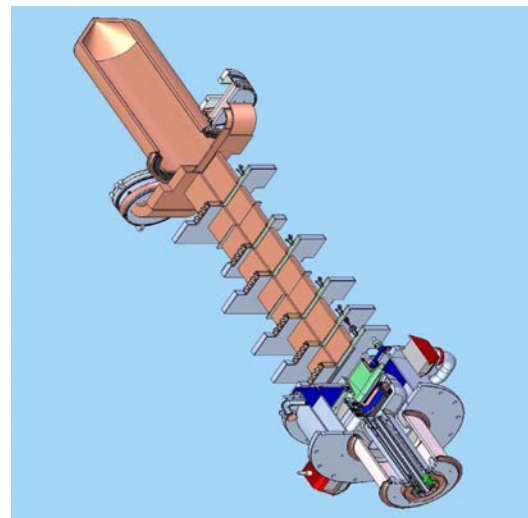

Figure 1: SBK Design.

### ELECTRON GUN

Many forms of gun geometry have been proposed over the years but several constraints forced the choice for the first ILC SBK effort. It was decided early on to make the device plug-compatible and to use  $2 \text{ A/cm}^2$  to increase theoretical lifetime. The desire for PCM Brillouin transport and the possible location of the pole tips and spacing further constrains the beam to be laminar and of a slightly hollow ( $\sim 10\%$ ) current density. For a laminar beam it is difficult to use a lineal convergence greater than 10:1. This loosely translates to a 100:1 area

\*Work supported by the Department of Energy under contract No. DE-AC02-76SD00515

convergence in a round beam. Also, a rectangular beam cross-section or a “racetrack” cross-section beam tends to break apart at the corners under the relatively weak PCM confinement fields without adding complexities of focusing or cross-sectional alterations to the drift tube. The PCM stack design has headroom to allow for ramping of the field toward the output (to account for the fields due to the bunching process) thus constraining the drift tube height and fill factor. After taking a few other constraints and the above factors into consideration, a 40:1 aspect ratio elliptical cross-section beam was decided upon. The cathode shape then was defined merely by the cross-sectional shape of the beam multiplied by the 10:1 lineal convergence and some undetermined cylindrical (or variable) radius.

With the beam in the drift tube and the cross section of the cathode both defined, a centerslice of the geometry along the “axis” (z) and the smaller of the two transverse dimensions (y) is created and a suitable 2D gun geometry arrived at using EGUN [1] and then MICHELLE [2]. With a cathode curvature defined by the 2D simulation and a starting point for the focus electrode and anode determined, numerous 3D simulations using MICHELLE were then performed and a final design arrived at as shown in Fig. 2. The resulting cathode current density varies from about 1.8 to 2.2 A/cm<sup>2</sup>, the focus electrode and anode peak gradients are below 60 and 72 kV/cm respectively, and the fill factor and beam shape are as planned within the numerical noise of the simulation.

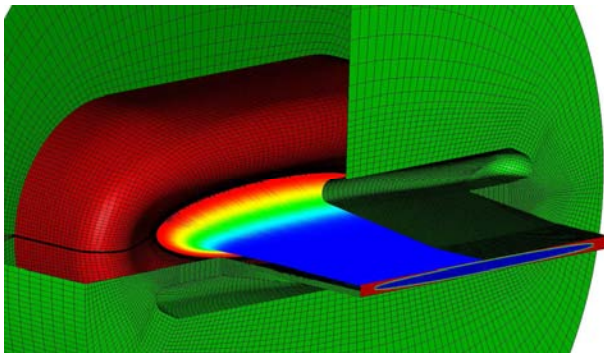

Figure 2: SBK Electron Gun.

The above process took quite some time and there are pitfalls concerning the representation of the beam and the fields wherever a discontinuity is encountered. These discontinuities are at the surface of the beam, including the cathode surface, and care must be taken to make proper adjustments for the emission and field algorithms, and to test each step of the way. Performing various sensitivity analyses convinced us early on that measuring the beam cross-section and validating the design would be a useful first step in the realization of the SBK.

### BEAM TESTER

A Beam Sampling Device (BSD) was designed to accurately quantify the beam coming from the electron gun. The BSD attaches to the anode plate of the SBK and

is removable for insertion of a beam propagation structure, the klystron structure, or other experiments. A quarter cut-out as shown in Fig. 3 shows the copper and carbon analysis target (copper color with black tip) set on a 3-axis stage for positioning across the transverse dimension of the beam with some axial movement. Total current is measured by a loss ring across the isolation ceramics and the beam is collected at the collector plate at right. The unit is design only for modest repetition rates and microsecond pulse lengths.

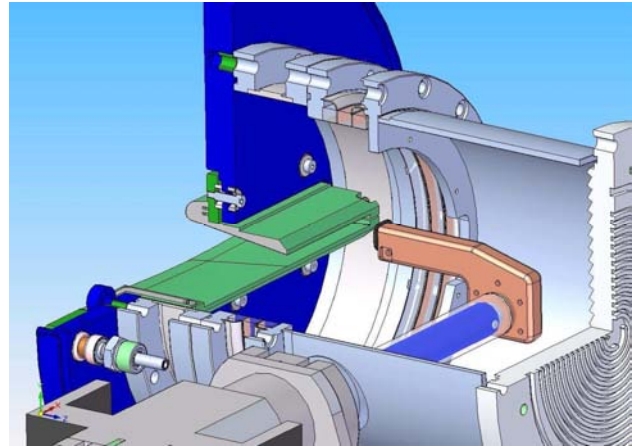

Figure3: BSD Cutaway.

The designed beam thickness at the beam minimum is 0.18”. To make a reasonable measurement of the beam profile a cup with a 0.008” diameter collection hole was chosen as shown in Fig. 4 (this is the carbon tip alluded to in Fig. 3). Since scattering and multipactor can confuse results, FLUKA [3] and MICHELLE were used to simulate the effects and a concentric geometry with a +/-1 kV bias voltage between the electrodes was chosen.

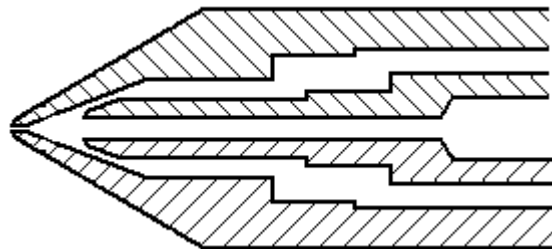

Figure 4: BSD tip. cross section

The BSD System includes the BSD and also modifications to the electron gun which most likely will never find their way into a practical device due to complexity and cost. For instance: the cathode anode gap spacing is adjustable to alter the perveance; the focus electrodes are separately biased to steer the beam up and down to make it smaller or larger and to inhibit cathode edge emission; an oil heat exchanger is present to cool the densely-packed gun stem; and, two large inductors are packed into the gun stem and used to prevent damage to the bias supply.

## BEAM PROPAGATION

With only  $20 \text{ A/cm}^2$  average beam current density the required confinement field is less than 300 G RMS. Such a beam is quite sensitive to stray magnetic fields so any magnet system must provide external shielding, even for earth's field. Solenoid, Wiggler and PCM schemes were all investigated. Only PCM and solenoid designs were considered after investigations of the wiggler schemes revealed several drawbacks.

For a solenoid the desired elliptical beam shape is not optimum due to the effects at the wide edge of the beam that cause distortion due to rotation. Ideally, a "racetrack" cross-sectional geometry works best for solenoid focusing since the beam can theoretically rotate about the edge with little distortion. To reduce the distortions in an elliptical beam one might use a slightly higher confinement field and/or alter the static field profiles at the beam corners. However, the design goal was for a PCM system with a solenoid as a backup thus the final solenoid scheme was simply a field from  $\sim 400 \text{ G}$  ramping to  $\sim 800 \text{ G}$  at the output.

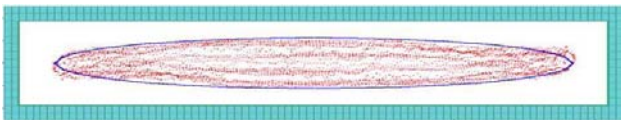

Figure 5: DC Beam cross-section after PCM transport.

The baseline PCM structure design uses radial permanent magnets mounted on a common flux return. The magnets consist of identical small blocks that are of the same energy product mounted between two iron pole pieces. Ramping of the field profile is accomplished by increasing the number of blocks on a pole piece. For fine-tuning on the bench, in order to center the field at the midplane and to adjust the field strength, a tuning slug is provided to shunt field across each half-period. Side focusing is accomplished by means of shaping the pole piece tips with rectangular features. The DC beam profile in the constant PCM field is relatively unchanged from the beam minimum, a few inches past the anode, to the output cavity as shown in Fig. 5. When a ramp is included to counteract the fields due to rf bunching the cross section does not maintain its shape but the beam still makes it down the drift tube without interception.

## KLYSTRON DESIGN

The rf parameters for the ILC call for a 1.3 GHz 10 MW 1.6 ms rf output pulse, 5 Hz, 70 % efficiency and 10 MHz BW. Design and simulation of the rf interaction circuit, Fig. 6, was aided by the fact that 1D, 2D and 3D analysis all yield the same rf performance results due to: the low current density; the relatively low voltage; the high degree of cavity coupling; the flat field profile in the gaps; and, the high ratio of axial field to transverse field in the interaction region. The design meets the specification except that the efficiency may be as low as

68 %. However, optimization of the output will be performed during testing as described later.

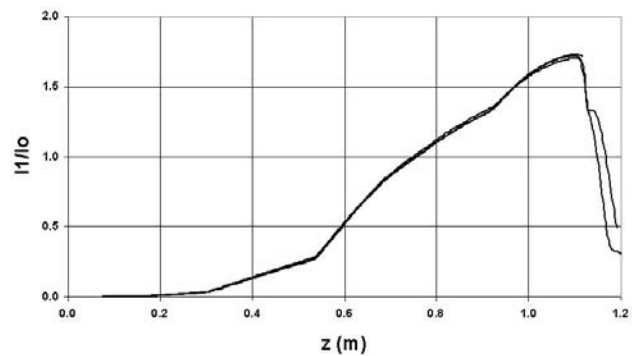

Figure 6: Fundamental bunching  $I_1/I_0$  for 1D, 2D and 3D codes are virtually identical

In order to meet the bandwidth and to monitor the assembled device, probes are inserted into the cavities as seen in Fig. 7. The probe, external loading and other experimental enhancements mentioned previously, would not occur in a production version.

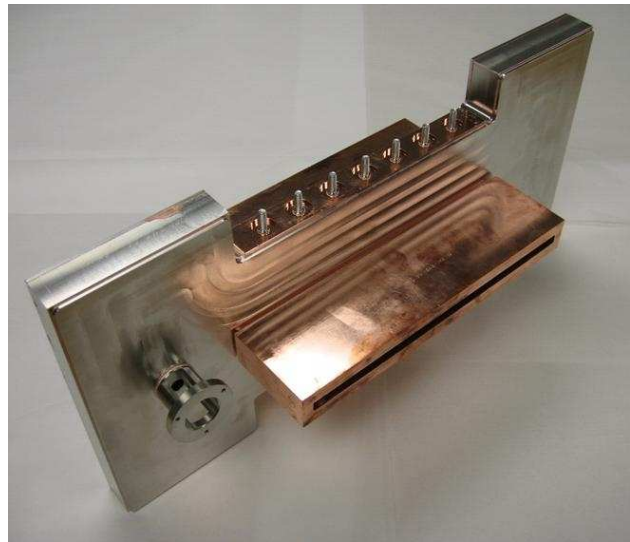

Figure 7: Cavity 2 with loading and sensor port.

The output system is also plug-compatible, using two coupling irises, waveguides and windows. For the experiment, variable-impedance devices will be attached to both output arms under full power operation and the match varied to optimize the output coupling. Some impedance element will then be fixed to future versions of the klystron output.

## OSCILLATION MITIGATION

Originally the program plan called for: 1) running the electrostatic beam into the BSD and analyzing the beam formation; 2) inserting a PCM drift tube structure between the gun and the BSD and analyzing the beam after propagation; 3) removing the drift tube and BSD, attaching the SBK and verify the operation; and, 4) running the klystron at long pulse at a different test

station. However, the plan was interrupted during 3D MAGIC [4] simulations when an oscillation of TE modes trapped between adjacent cavities was discovered as seen in Fig. 8. The modes give a vertical kick to the beam and are trapped due to the discontinuity between drift tube and cavity. The modes couple little to the cavity and are difficult to load down in the drift tube. Unfortunately the wavelengths are similar to the PCM period thus bandstops exist which depend on the spacing between the cavities, the period of the PCM and the strength of the focusing fields. With a 7-cavity design such as the SBK there are many possible interaction combinations.

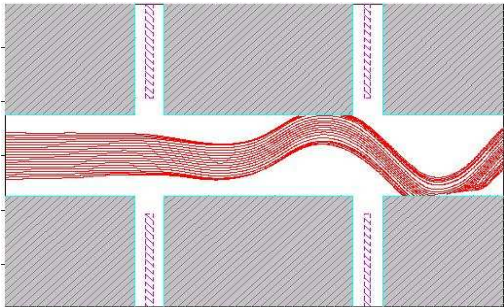

Figure 8: Side view of the 2-Cavity oscillation disrupting beam transport, PCM Brillouin.

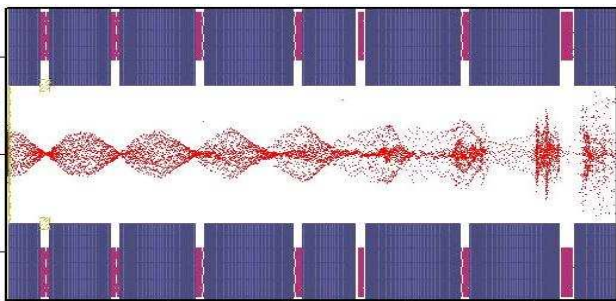

Figure 9: 10 MW 390 G RMS PCM design

Fortunately, the cavity coupling is excellent so there is a simple way to reduce these oscillations by increasing the drift tube height and allowing the modes to flow past the cavity, thereby reducing their respective Q values. By simply doubling the drift tube height it is believed that all the modes are eliminated by using any solenoid field above 300 G. There appears to be an operation point for PCM design at ~400 G as well. Simulations of the klystron are shown in Fig. 9 and Fig. 10 where full power is reached using the newer drift tube size without detectible oscillations. The PCM field is simply a constant 390 G but suffers a bit of interception at the output structure. We are currently investigating a PCM design to mitigate the interception but must incorporate issues raised by the new drift tube height. For the solenoid design it is simply a matter of adding a coil near the output region and increasing the field a bit to eliminate interception.

An analysis of a related SBK instability has been performed by Yu and Wilson [5], though such instabilities are different from the instability discussed here. Other

work has been applied towards a 2D theory at SLAC [6] and is the subject of a paper at PAC 2009. Current theory does not account for more than two cavities or the beam current of the SBK device and so PIC codes are relied upon.

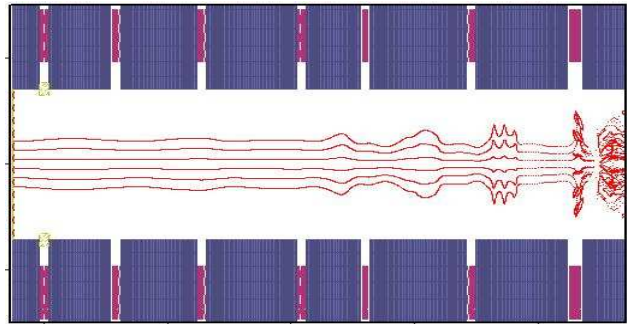

Figure 10: 10 MW 390 G-780 G solenoid design

The instabilities can be analysed in 2D or 3D PIC and, within constraints of reasonable computing resources, give very similar results. To properly translate from 3D to 2D one must account for the finite waveguide width, beam current profile, and a host of possible modes. To validate theory and simulations an experimental measurement is prudent. The plan mentioned at the beginning of this section will be modified during step 2 by using a PCM drift tube with the inclusion of 2 cavities. Simulation indicates, Fig. 11, using a PCM stack capable of providing 200 – 600 G, that the edges of the stability curve should be visible. Thus after performing a modified Step 2 of the plan the experimentation should be able to continue as before, culminating with a klystron in Step 4 that uses a larger drift tube.

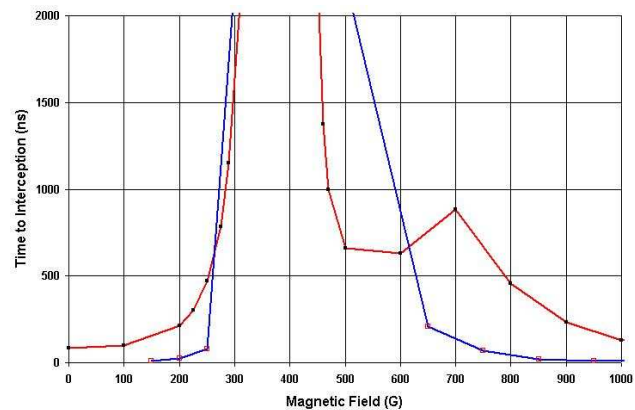

Figure 11: Stability curve of a 2-cavity PCM system (2D-red curve, 3D-blue curve)

## MODULATOR AND TESTING

Testing of the SBK is planned in two phases. The first phase is the major experimental phase where the BSD and SBK are operated in the Klystron Test Lab. The tube is processed, tested, analyzed and operated at 3-4  $\mu$ s pulselength. Any adjustments to cavity loading, cathode power, confinement field, the output structure match, the gun controls, and initial qualifications of performance and

such are done at Phase I tests. The second phase tests only the SBK and will take place in a different building where a prototype ILC modulator is installed and capable of operating at the full ILC pulse length. At this point the long-pulse operation of the SBK will become evident in terms of heating, DC or RF breakdown, or low growth-rate instabilities. The design is such that heating and breakdown should be no different than an MBK. The latter point is still under investigation and awaiting verification of theory and simulations from Step 2 of the previous section.

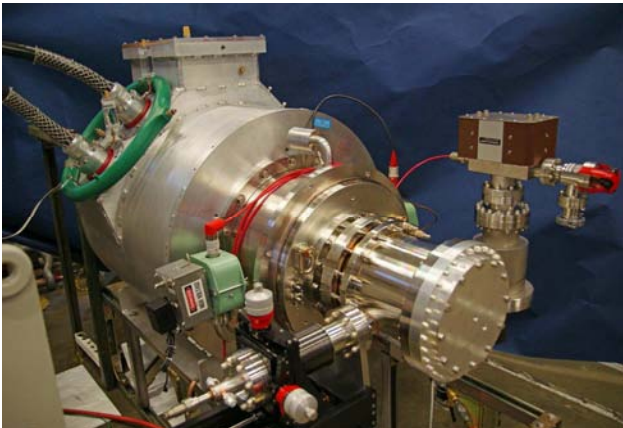

Figure 12: BSD mounted to small oil tank and connected to modulator

To accommodate Phase I and II testing a small oil tank was constructed which is transportable between test stations. Two High-Voltage DS2077 coaxial cables are used to connect between a modulator and the portable tank as seen in Fig. 12. The cathode heater power is across the two cables. As seen, the cable currents are measured via a toroid as they enter the tank by connection through the high power bushings. Attached to the tank is the BSD with its associated vacuum pumps and 3-axis adjustment. A fiber-optical link communicates from outside the tank to the two parasitic (from the heater) focus electrode bias supplies. From the far side (not shown) is the mechanical adjustment of the cathode-anode gap. Currently the BSD experiment is ready to begin. The same small oil tank will be used for the SBK and after testing in the Klystron Department, moved to the Phase II location along with the SBK.

The modulator is from Diversified Technologies and uses a capacitive storage system with an IGBT switching scheme into a 6.33:1 pulse transformer. For BSD experiments a flat pulse is highly desirable thus several changes were incorporated to the DTI system: a parallel load of 500-1100  $\Omega$ , a reduction of the series inductance between the transformer and switch; and, provisions for tuning the debouncing inductors while pulsing. With these changes a resistive load of 850  $\Omega$  (to model the SBK gun) was tested in the small oil tank and the

components were varied. The data is undergoing investigation to determine whether further flattening of the pulse is possible beyond  $\sim 1\mu\text{s}$  as shown in Fig. 13.

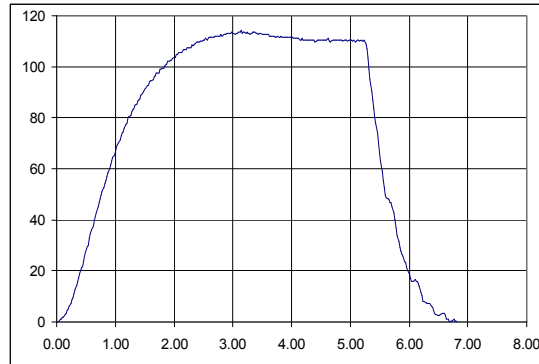

Figure 13: kV vs. microseconds for the modulator pulse into an 850  $\Omega$  load

## SUMMARY

A design for an electron gun, tank, and BSD experiment has been completed and testing is ready to begin. A drift tube, using PCM focusing and 2-cavities, is under design, and many parts are on hand. Testing of the drift tube BSD experiment should occur this fiscal year to validate theory and simulations of the trapped modes. Due to the detection of trapped modes during 3D PIC simulations of the SBK, some mechanical modifications of the parts (drift tube, cavities and PCM stack or solenoid) must be made. Testing of the SBK device should commence sometime during the next fiscal year.

## REFERENCES

- [1] W.B. Herrmansfeldt, "EGUN - An Electron Optics and Gun Design Program", SLAC report 331, 1988.
- [2] John Petillo, et al., "The MICHELLE Three-Dimensional Electron and Collector Modeling Tool: Theory and Design", IEEE Trans. Plasma Sci., vol. 30, no. 3, June 2002, pp. 123 8-1264.
- [3] A. Ferrari, et. al., "An improved multiple scattering model for charged particle transport" Nucl. Instr. Meth. in Phys. Res. B71, 412-426 (1992)
- [4] B. Goplen, L. Ludeking, D. Smithe, and G. Warren, "User-Configurable MAGIC Code for Electromagnetic PIC Calculations," Computer Physics Communications, Vol. 87, Nos. 1 & 2, May 1995, pp. 54-86.
- [5] D. Yu and P. Wilson, "Sheet-beam klystron RF cavities" in Proc. Particle Accelerator Conf. (PAC93), May 17- 20, 1993, pp. 2681-2683.
- [6] K.L.F. Bane, et al., "Sheet Beam Klystron Instability Analysis". in Proc. Particle Accelerator Conf. (PAC09), May 4-8, 2009