

INTERACTION REGION UPGRADES OF E^+E^- B-FACTORIES*

M. Sullivan[†], Stanford Linear Accelerator Center, P.O. Box 20450, Stanford, CA 94309
for the PEP-II team

Abstract

Both the PEP-II and KEKB B-Factories have plans to upgrade their Interaction Regions (IRs) in order to improve luminosity performance. Last summer PEP-II added cooling to the IR beam pipe in order to increase beam currents thereby raising the luminosity. In addition, PEP-II is working on a design that modifies the permanent magnets near the Interaction Point (IP) for an even higher luminosity increase. KEKB is also planning an improvement to their IR that will decrease the detector beam pipe radius. In addition, KEK has a design to increase the luminosity of KEKB to $1 \times 10^{35} \text{ cm}^{-2} \text{ sec}^{-1}$ which includes changes to the IR. PEP-II is also investigating the feasibility of a $1 \times 10^{36} \text{ cm}^{-2} \text{ sec}^{-1}$ luminosity design. I summarize these various upgrades and concentrate on issues common to the different designs.

1 INTRODUCTION

The two asymmetric-energy B-Factories, PEP-II and KEKB, have made and are in the process of making improvements in the IR. The IR plays an important role in any effort to improve luminosity performance. Table 1 lists several accelerator parameters that are important for more luminosity and that have an influence in the IR.

Table 1: Some accelerator parameters that are related to luminosity and are important to the IR.

	PEP-II		KEKB	
	Present	Design	Present	Design
E^- (GeV)	9.0	9.0	8.5	8.5
E^+ (GeV)	3.1	3.1	3.5	3.5
Γ (A)	1.1	0.75	1.0	1.1
I^+ (A)	1.7	2.1	1.4	2.6
n_b	939	1658	1284	5000
I_b^- (mA)	1.17	0.45	0.78	0.22
I_b^+ (mA)	1.81	1.29	1.09	0.52
β_x^* (cm)	35	50	60	33
β_y^* (mm)	11	15	6-7	10
L ($\times 10^{33}$)	6.1	3.0	10.0	10.0
Collision	Head-on		± 11 mrad xing ang.	

*work supported by the Department of Energy under contract number DE-AC02-76SF00515.

[†]sullivan@slac.Stanford.edu

As we can see from the table, both accelerators have increased luminosity by increasing the bunch current in both beams. In fact, PEP-II has achieved twice the design luminosity with a little over half the number of design bunches and with significantly more design HER beam current, while KEKB has just reached design luminosity with only a little over 25% of the design number of bunches and with nearly the design HER current. These higher bunch currents have greatly increased the HOM power produced in these machines when compared to the original estimates. This, in turn, has led to heating issues for both accelerators. Both accelerators are also attempting to lower the β_y^* as much as possible to further increase the luminosity. In order to benefit from this decrease the bunch length must be shortened to a comparable size. Shortening the bunch length also increases HOM power.

2 PEP-II

The PEP-II accelerator [1] uses strong horizontal dipole permanent magnet (PM) magnets (B1) to bring the 9 GeV and 3.1 GeV beams into a head-on collision. These 0.5 m dipoles start at 0.21 m from the IP. The beams then travel through a 1.2 m shared PM vertically focusing quadrupole that starts at 0.9 m from the IP. This quadrupole (QD1) is centered on the high-energy beam (HEB) orbit in order to maximize the horizontal bending of the low-energy beam (LEB) and separate the beams enough to place QF2, a horizontally focusing septum magnet for the LEB, 2.8 m from the IP. Figure 1 shows a layout view of the PEP-II IR.

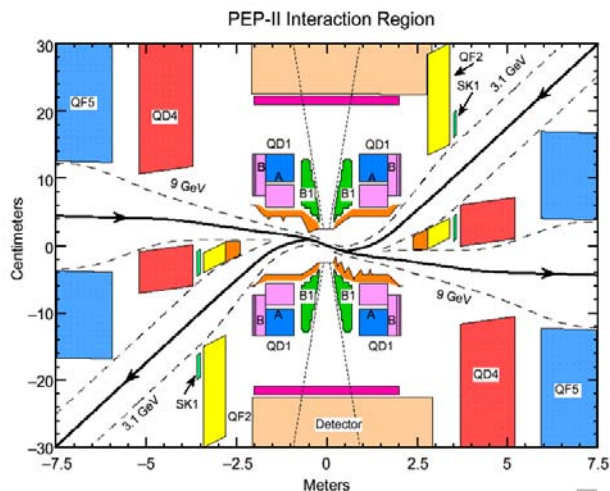

Figure 1. Layout of the PEP-II Interaction Region. Note the expanded vertical scale. The beams are brought into a head-on collision by the (~ 0.8 T) dipole magnets (B1).

Outboard of QF2 are the two final focus magnets for the HEB, QD4 and QF5. Both of these magnets are also septum magnets. The QD4 magnets are positioned such that the HEB travels through the magnet with a 14 mm offset. This offset horizontally steers the HEB so as to direct the produced quadrupole synchrotron radiation (SR) from the QF5 magnet away from the Be beam pipe located at the collision point.

SR masks under the B1 magnets shield the Be chamber from direct SR and all radiation from upstream sources as well as from backscattered downstream surfaces must bounce off of at least two surfaces before they can strike the Be chamber. Primary detector backgrounds for the silicon vertex tracker (SVT) come from off-energy beam particles (Beam-gas-Bremsstrahlung or BGB) that are swept out in the horizontal plane by the upstream Q4 magnet for the HER and the upstream Q1 and B1 magnets for the LEB.

The Be beam pipe consists of two thin walls (800 μ m and 400 μ m) with a 1.2 mm water channel between the walls. The water absorbs the power deposited in the chamber from HOMs and resistive wall losses. At typical operating beam currents the Be chamber water absorbs about 1 kW of power. At each end of the Be is located a small 2 convolution bellows that is designed to minimize stresses in the chamber when nearby beam pipes move from thermal heating. The chambers on either side of the Be beam pipe are composed of mixtures of copper and dispersion strengthened copper (GlidCop). The GlidCop pieces absorb the significant amount of SR power that strikes the masking (\sim 3 kW from the LEB and \sim 1 kW from the HEB).

The entire assembly of Q1 and B1 magnets with copper and Be beam pipes is rigidly held in a support tube that is positioned inside the BaBar detector. The ends of the support tube couple to the rafts on either side of the detector that hold the Q2, Q4 and Q5 magnets. The bellows at each end of the support tube connect to the Q2 vacuum chamber where the beams go into separate beam pipes. This junction of two beam pipes to the one beam pipe in the support tube generates significant HOM power (\sim 5 kW) which is absorbed by silicon carbide tiles brazed into the two bellows sections at the ends of the support tube.

Last year, we discovered that the small bellows on either side of the Be beam pipe were getting hot through heating from HOM power penetrating the internal RF shields. The heating was observed by a thermocouple attached close to the bellows (see Fig. 2). The shields were designed to protect the bellows from longitudinal modes but the presence of the nearby SR masks can convert these modes into transverse modes. In particular, an H11 mode generated at an angle that couples to the longitudinal electric field [2]. (See Figs. 3 and 4.) These transverse modes can penetrate the longitudinal slits and deposit power in the stainless steel bellows convolutions.

The temperature rise was about 100°F at the thermocouple which, in itself, was not too alarming but the computer model for the heating of the bellows

indicated that the actual bellows convolutions were significantly hotter (\sim 300°C).

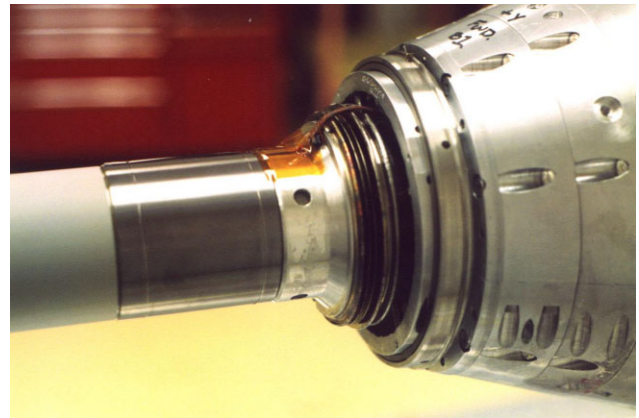

Figure 2. Picture of the small bellows convolutions near the Be beam pipe that heat up from HOM power. The thermocouple that registered the heat can be seen. The location of the thermocouple is between the bellows and the Be beam pipe which is covered with a sheet of Ta. The computer model of this area indicated that the bellows convolutions were much hotter than the readings from the thermocouple. The permanent magnet slices of the B1 magnet are shown to the right of the bellows.

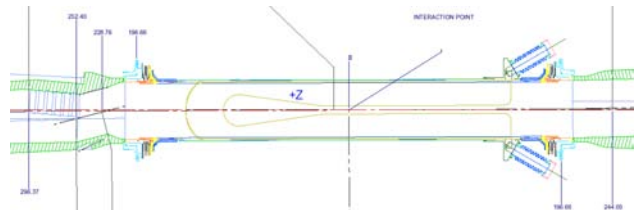

Figure 3. Drawing of the Be beam pipe and bellows sections at each end of the Be. The Be is brazed to stainless steel sleeves and the bellows sections are welded to the SS sleeves. The Be is cooled by water which enters and exits through the tubing on the right side of the drawing. The main SR mask for the LEB can be seen on the left and is 25 cm from the IP, the SR mask for the HEB is located on the right side but is farther away (50 cm from the IP) and is not seen.

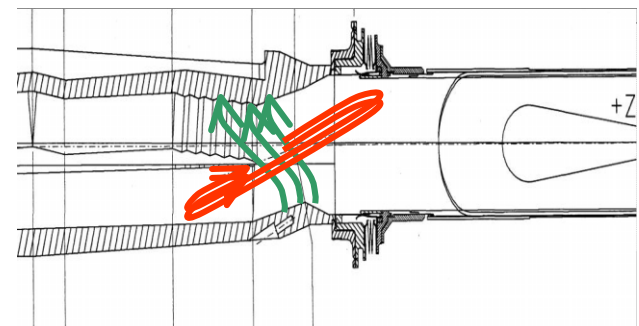

Figure 4. Detail drawing of the LEB SR mask and bellows section. The green arrows indicate the electric fields of the passing beam bunches and the subsequent magnetic field lines (in red) from H11 that can penetrate the slots in the RF shield of the bellows.

Last summer, we removed the support tube in order to add cooling to these small bellows near the Be beam pipe. In addition, we also rebuilt the Q2 chamber on the detector forward side and increased the number of HOM power absorbing tiles in the bellows sections at the ends of the support tube. So far, the results are very encouraging. The heating in the small bellows is very well controlled and should not become a problem until the heating increases by at least a factor of three. The temperature rise at the original thermocouple location is now 40°F for almost the same amount of beam current. Figs. 5 and 6 show further details about the cooling improvements.

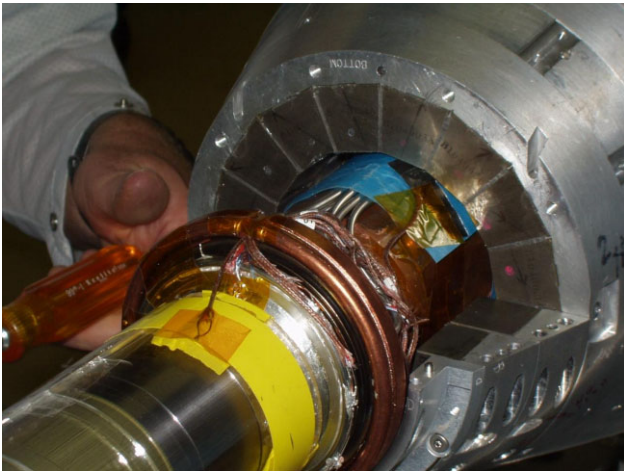

Figure 5. Picture of the cooling system that we installed last summer. The first 3 slices of B1 magnetic material were removed for access to the area. The small tubes (1/8 in. stainless steel) of air and water were threaded under the B1 magnet and can be seen between the bellows and the magnetic material. Three separate water circuits and two separate air circuits were installed for each bellows section. Each air circuit has two independent supply tubes.

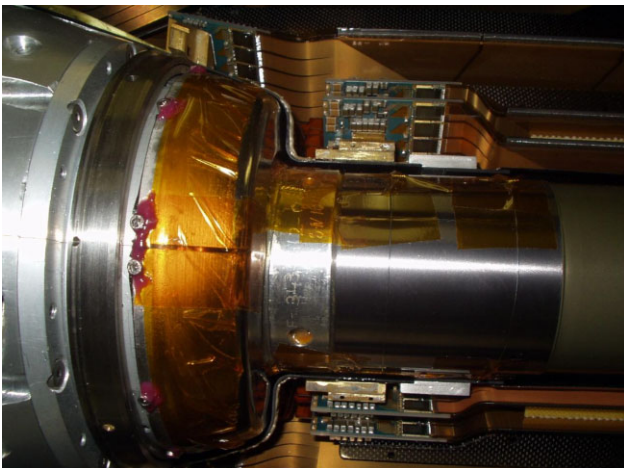

Figure 6. Picture of the new cooling covered by the final air shield to minimize the amount of air blowing at the SVT. One also sees one half of the SVT installed. The SVT is mounted on the small gimbal ring seen to the left in the photo. The bellows section on the other side of the

Be beam pipe was also cooled with the new air and water circuits described above even though that side has better cooling from the Be water cooling system.

3 KEKB

The KEKB IR design has several distinct differences when compared to the PEP-II design. KEKB collides the two beams with a ± 11 mrad crossing angle thereby eliminating the need for strong horizontal dipoles to separate the beams. In addition, the 3.5 GeV positron and 8 GeV electron beams enter the IR on-axis in all incoming quadrupoles. This eliminates any strong SR fans from bending magnets upstream of the IP and minimizes SR backgrounds in the detector. Figure 7 shows a layout of the KEKB IR.

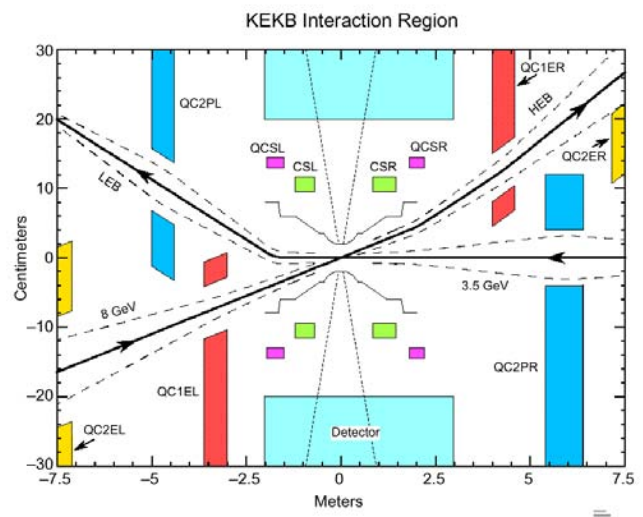

Figure 7. Layout of the KEKB IR. The incoming beams are on-axis and the outgoing beams are off-axis in the shared QC1EL and QC2EL superconducting quadrupoles. Note the expanded vertical scale. For comparison, the scales in this plot are the same as the scales used for the PEP-II layout in Figure 1.

SR from quadrupole magnets (focusing radiation) is still an issue and, in general, masks are still needed close to the IP to protect the detector Be beam pipe from this SR. The KEKB design has two small SR masks located near the Be beam pipe for just this purpose. See fig. 8 for more details.

The KEKB design, like PEP-II, has the quadrupole nearest to the IP shared by both beams. This means that the outgoing beams are far off-axis as they travel through these shared inner quads. The outgoing beams then generate SR fans of significant power, part of which can backscatter from surfaces relatively close to the detector and be seen as a background in the silicon vertex detector (SVD) located around the Be beam pipe.

KEKB has also experienced heating near the Be beam pipe from HOM power. They have replaced one Be chamber due to heating issues and have had one Be beam

pipe fail in a manner that has not been fully understood but was probably related to a heating issue.

4 NEAR TERM UPGRADES

Both B-Factories have plans for near-term upgrades in the IR that are designed to improve machine performance.

4.1 KEKB

This summer KEKB will replace the 2.0 cm radius Be beam pipe with a new smaller radius (1.5 cm) beam pipe in order to improve the detector vertex resolution by making room for another layer of tracking detectors and by getting radially closer to the IP [3]. The new design has no SR masks near the Be beam pipe in order to eliminate these “mode converters” and minimize the HOM power generated near the Be beam pipe. Figure 8 shows the difference between the present and new beam pipes. The new beam pipe will use a liquid coolant rather than the present design which employs He gas.

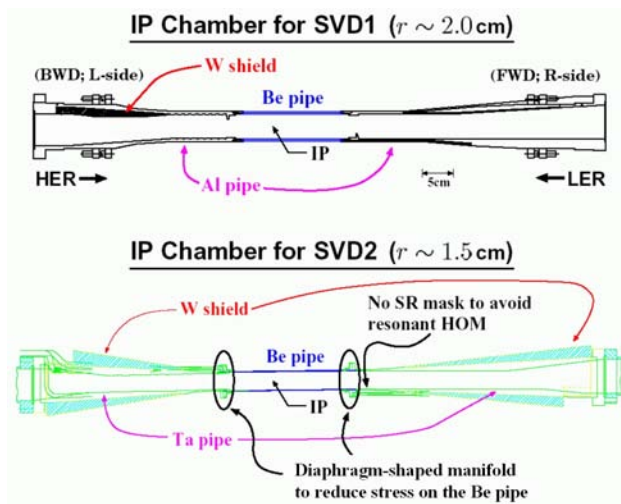

Figure 8. Drawings of the present KEKB Be beam pipe with some of the shielding and masking and of the new Be beam pipe to be installed this summer. Note that the two small SR masks in the present beam pipe are not preserved in the new beam pipe. The lost particle (BGB) shielding has also been improved. The smaller beam pipe radius is also evident.

4.2 PEP-II

PEP-II also plans to upgrade the IR in 2005. The strong dipole magnets will be modified with the last 20 cm of the dipole field being replaced by a strong focusing quadrupole field. This effectively moves the Q1 magnet closer to the IP allowing for lower β_y^* values at the collision point. This change reduces the B-dl of the dipole field from 0.329 T to 0.176 T and introduces a small (± 3.25 mrad) crossing angle at the IP. The change also greatly reduces the total amount of SR generated by these dipoles. The crossing angle separates the beams more quickly which decreases the tune shift seen by the beams at the parasitic crossings on either side of the collision point and opens up the possibility of putting bunches in

every RF bucket for a total number of 3400 bunches. This upgrade is being designed to allow the β_y^* values to go down to 5 mm. Lowering the β_y^* down to 5 mm of course means that PEP-II will also have to concentrate on making the bunch length shorter than the present values of 11-13 mm. The shorter bunches will then also increase the HOM power generated in the IR. Figure 9 shows a layout of the upgraded PEP-II IR.

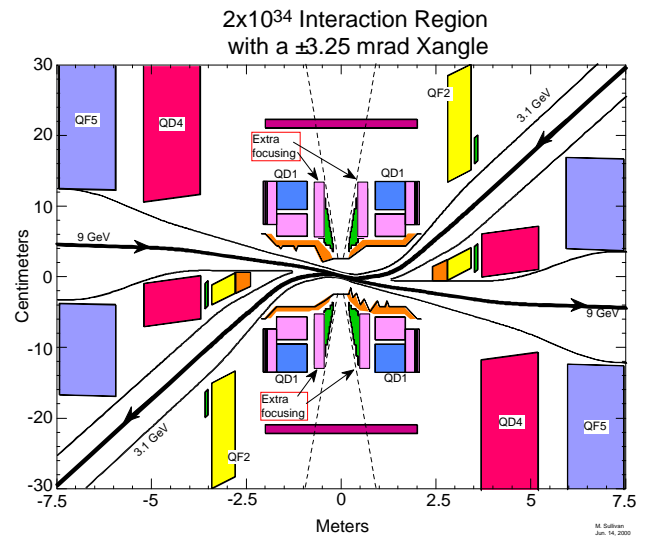

Figure 9. Layout of the upgraded PEP-II IR. Note the expanded vertical scale. The last four slices (20 cm) of the B1 magnets have been replaced with quadrupole field to increase the focusing and effectively move the QD1 magnet closer to the IP.

5 VERY HIGH LUMINOSITY IRS

Both B-Factories are also working on designs to greatly increase the luminosity. Both designs call for increased beam currents (10-25 A) and for still lower β_y^* values (1.5–3 mm). HOM power will be a major concern for these high-current machines.

5.1 SuperKEKB

KEK has a well-developed design to upgrade KEKB to a $1 \times 10^{35} \text{ cm}^{-2} \text{ sec}^{-1}$ luminosity machine [4-5]. The beam currents are 9.4 A for the LEB and 4.1 A for the HEB. The β_y^* value is 3 mm and the bunch length is 3 mm. The design for the IR is very similar to the present KEKB (see Figure 10). The incoming beams are, again, on-axis and the outgoing beams are off-axis in the shared quadrupoles that are closest to the IP. The crossing angle has been increased to ± 15 mrad in order to preserve beam separation and maintain the option of putting beam into every RF bucket (~ 5000). This increase in the crossing angle will tend to increase the amount of locally generated SR on top of the large current increases and controlling this SR power will have to be studied very carefully.

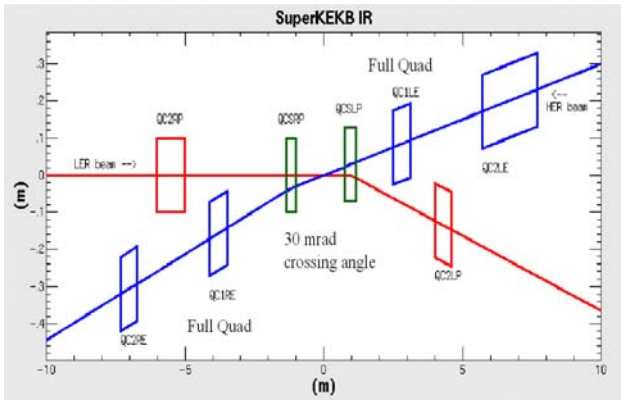

Figure 10. Layout of the superKEKB IR design. The superconducting quads are closer to the IP. In order to get a similar beam separation as the present KEKB, the crossing angle has been increased to ± 15 mrad.

5.2 A 1×10^{36} Luminosity PEP-II

For PEP-II, the very preliminary IR design for a 1×10^{36} $\text{cm}^{-2} \text{sec}^{-1}$ luminosity machine employs a crossing angle of ± 12 mrad similar to the present KEKB machine [6]. The design has symmetric optics and orbits and that means that SR fans are generated in the upstream shared quadrupoles. The power from the fans is quite large due to the very high beam currents and care must be taken to properly absorb this power and to account for the backgrounds from these fans as well as the from the quadrupole focusing radiation. Figure 11 shows a layout of the IR for a 1×10^{36} luminosity design. The beam currents are 22 A for the LEB and 10 A for the HEB, but other designs are being considered with currents of 16 A and 7 A respectively. The β_y^* values go as low as 1.5 mm. The beam energies for this design are 8 GeV for the HEB and 3.5 GeV for the LEB.

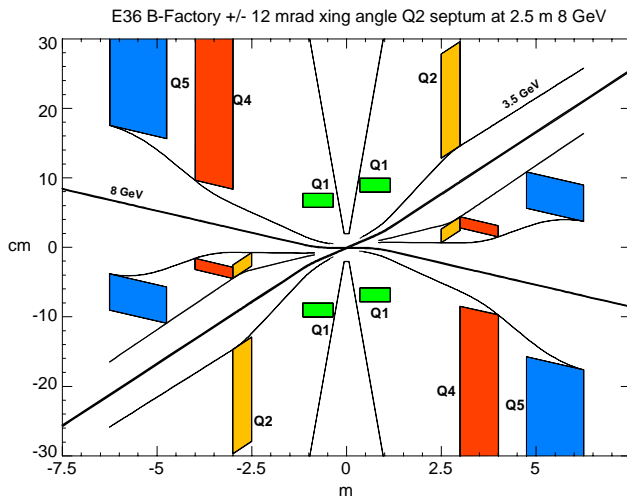

Figure 11. Layout of a preliminary design for the IR of a $1 \times 10^{36} \text{cm}^{-2} \text{sec}^{-1}$ luminosity machine at SLAC. There are no dipole magnets to bring the beams into collision. Instead a crossing angle of ± 12 mrad is used. The shared quadrupoles are superconducting and are symmetrically positioned to generate the same bending in the beam

upstream as well as downstream of the IP. The SR fans generated by these beams are shown in the figure. The powerful HEB beams stay inside the beam envelope until at least more than 10 m from the IP thereby allowing the power to spread out and become more manageable. The SR fans from the LEB start to strike the beam pipe about 5 m from the IP.

6 SUMMARY

The present B-Factories have achieved very impressive luminosity peaks with far fewer bunches than was assumed in the original designs. The beam currents, however, are approaching and, in some cases, exceeding the design values. This combination has greatly increased the single bunch current and this has, in turn, increased the HOM power. The increase in HOM power has been seen in both B-Factory interaction regions and both factories have had to improve cooling near the Be beam pipe due to HOM power. Future upgrades to these IRs have to include HOM power implications.

Designs of even higher luminosity B-Factories entail large beam currents and short bunch lengths, both of which increase the total HOM power. In addition, the large beam currents generate intense synchrotron radiation fans in the IR of these designs that must be kept under control. Experience from the present B-Factories will be an invaluable benchmark for estimating the HOM power, SR backgrounds, beam-gas backgrounds and heating from these very high current machines.

7 ACKNOWLEDGEMENTS

We wish to thank the SLAC staff for their dedicated support of the PEP-II accelerator. We especially thank the operations group for their unflinching effort to keep this machine running and for tuning the machine to ever higher luminosities.

8 REFERENCES

- [1] "PEP-II an Asymmetric B Factory", Conceptual Design Report, CALT-68-1869, LBL-PUB-5379, SLAC-418, UCRL-ID-114055, UC-IIRPA-93-01, June 1993.
- [2] A. Novokhatski, "IR2 IP HOM Calculations and Measurements", PEP-II Performance Wkshp, Jan 2002 http://www.slac.stanford.edu/~sullivan/PEP-II_perf_wkshp_2002/IPhoms_Novo.pdf
- [3] T. Abe, "IP Chamber for SVD2", KEKB Rev. Feb 10-12, 2003 http://www-kekb.kek.jp/review_2003/abe.pdf
- [4] <http://www-kekb.kek.jp/SuperKEKB/EoI.pdf>
- [5] N. Ohuchi, "Interaction Region Design for SuperKEKB", KEKB Review Feb 10-12, 2003 http://www-kekb.kek.jp/review_2003/ohuchi.pdf
- [6] M. Sullivan, "IR Upgrades and Options", SLAC Long-Range Scenarios, Mar 20, 2003 http://www.slac.stanford.edu/~sullivan/IR_upgrades_Bday.pdf