

$DY \cos 2\phi$ correlation at leading twist from double ISI

Anomalous effect from Double ISI in Massive Lepton Production

Boer, Hwang, sjb

$\cos 2\phi$ correlation

- Leading Twist, valence quark dominated
- Violates Lam-Tung Relation!
- Not obtained from standard PQCD subprocess analysis
- Normalized to the square of the single spin asymmetry in semi-inclusive DIS
- No polarization required
- Challenge to standard picture of PQCD Factorization

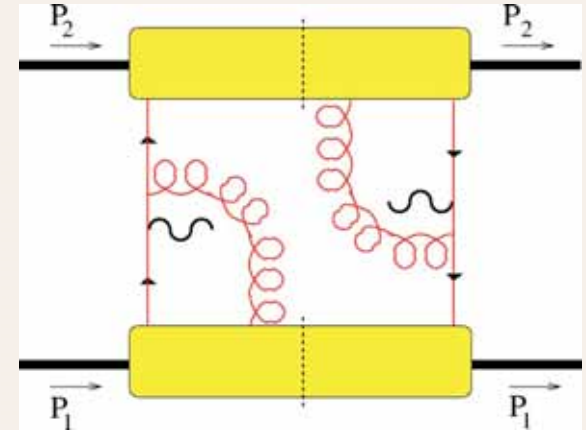

Double Initial-State Interactions

generate anomalous $\cos 2\phi$

Boer, Hwang, sjb

Drell-Yan planar correlations

$$\frac{1}{\sigma} \frac{d\sigma}{d\Omega} \propto \left(1 + \lambda \cos^2 \theta + \mu \sin 2\theta \cos \phi + \frac{\nu}{2} \sin^2 \theta \cos 2\phi \right)$$

PQCD Factorization (Lam Tung): $1 - \lambda - 2\nu = 0$

$$\frac{\nu}{2} \propto h_1^\perp(\pi) h_1^\perp(N)$$

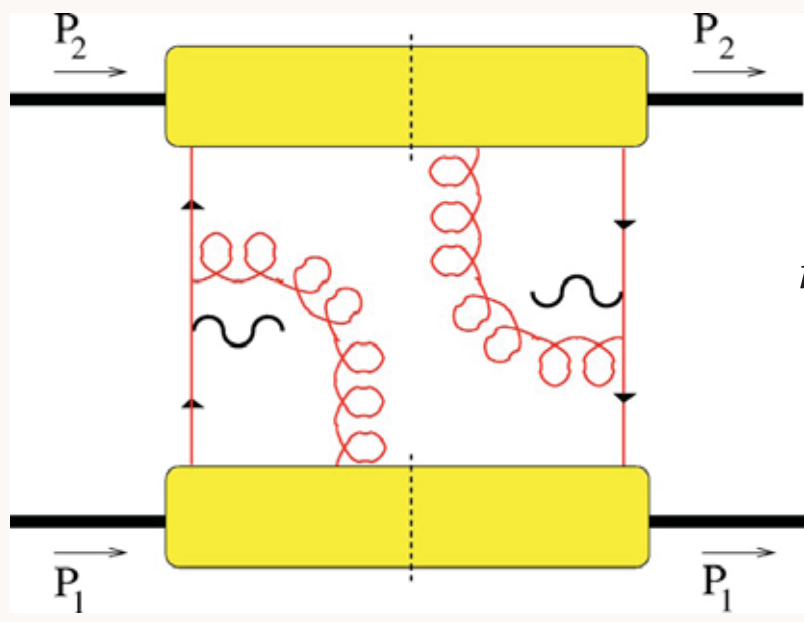

Violates Lam-Tung relation!

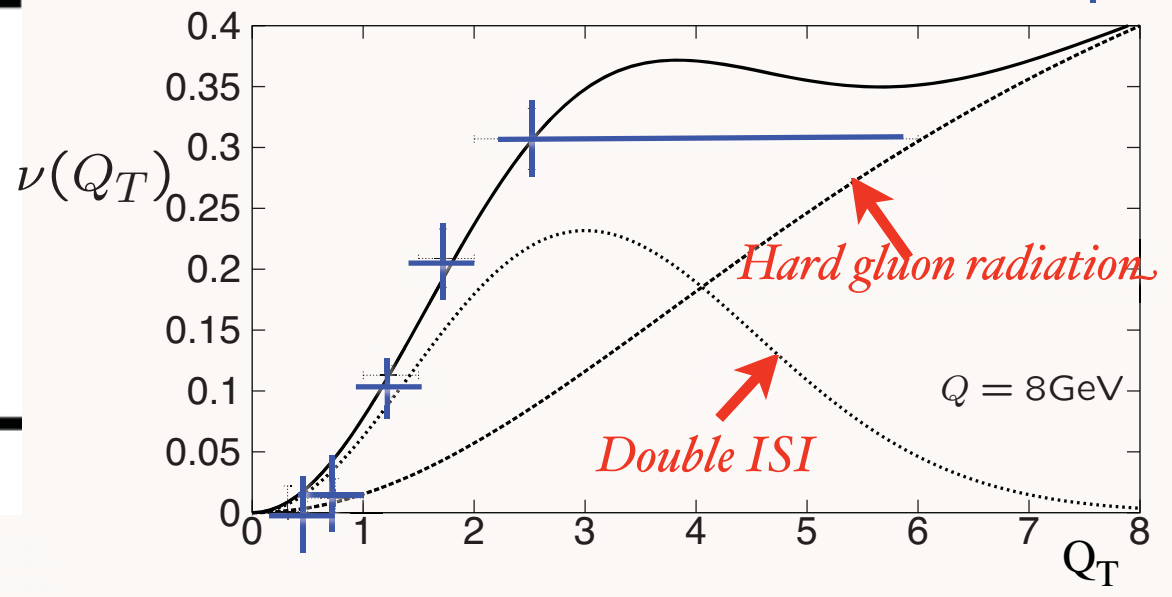
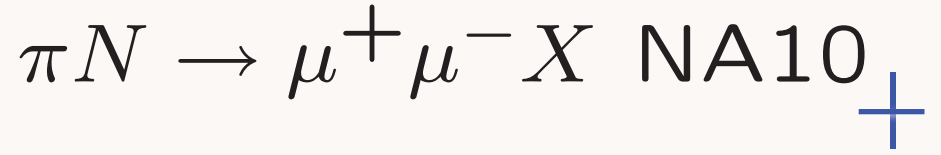

Model: Boer,

Stan Brodsky, SLAC

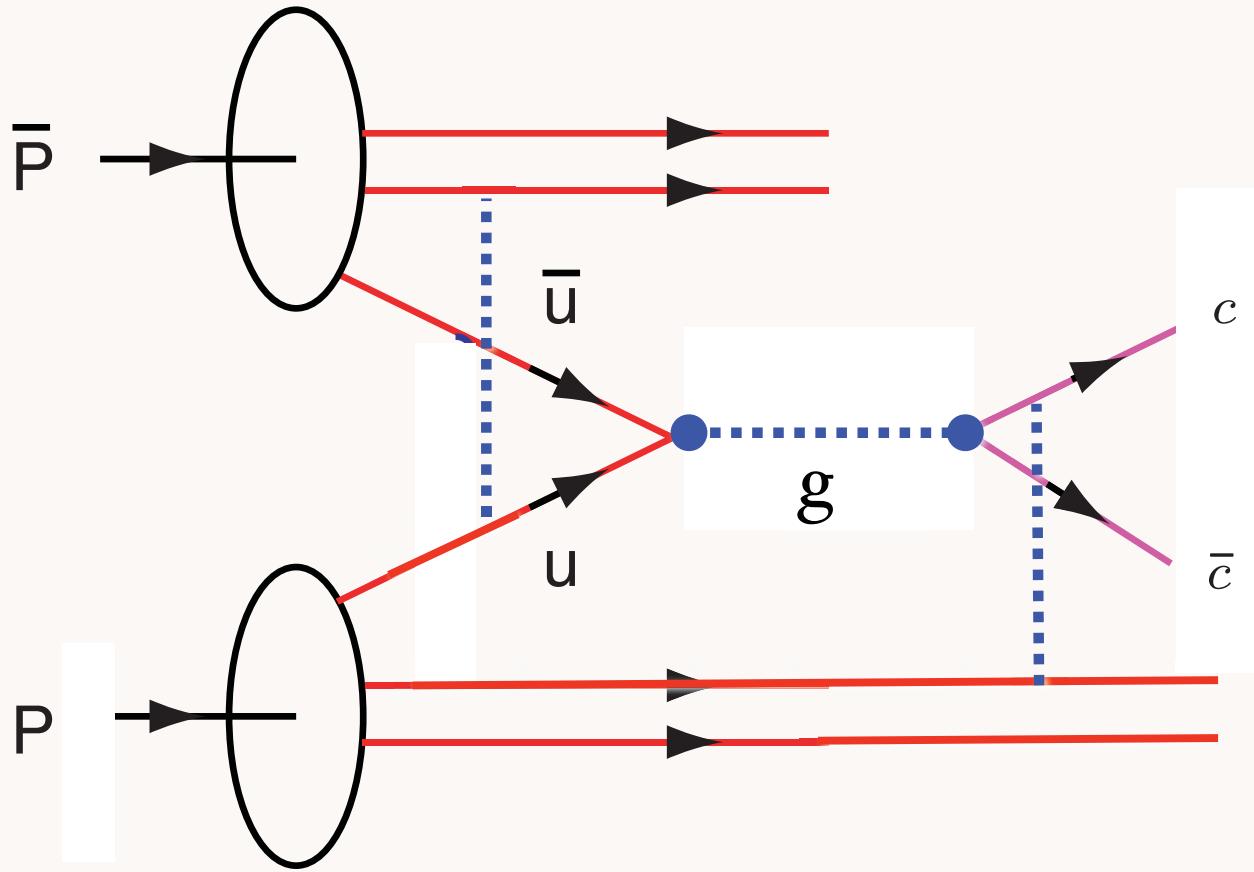

Problem for factorization when both ISI and FSI occur

Factorization is violated in production of high-transverse-momentum particles in hadron-hadron collisions

John Collins, [Jian-Wei Qiu](#) . ANL-HEP-PR-07-25, May 2007.

e-Print: [arXiv:0705.2141](#) [hep-ph]

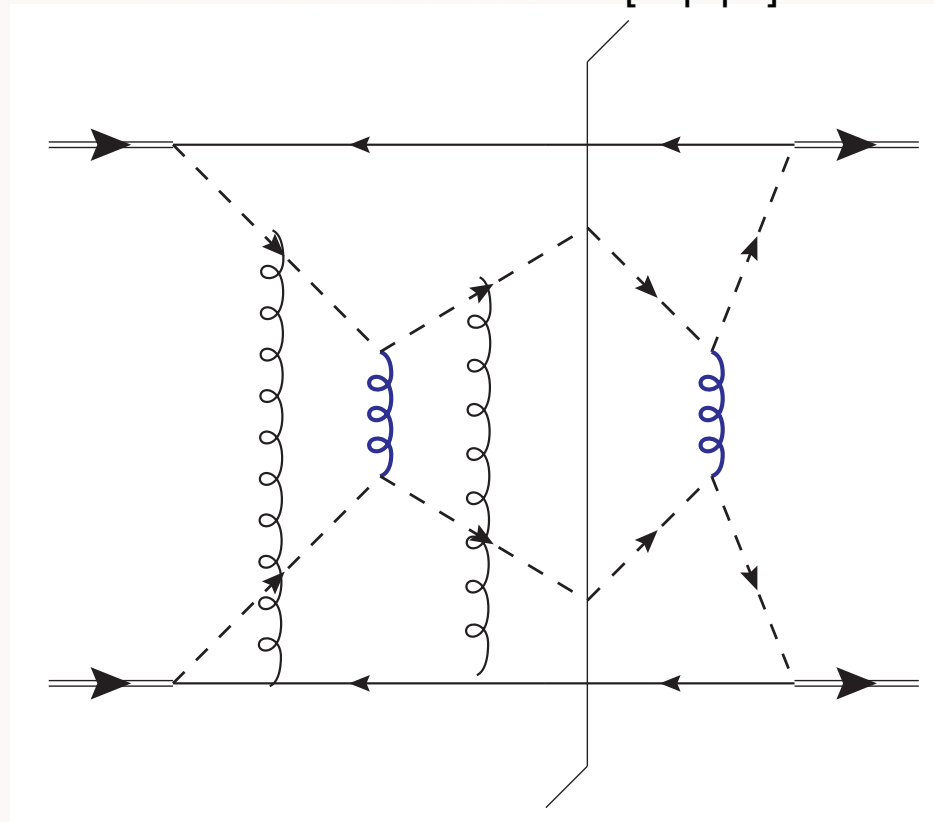

The exchange of two extra gluons, as in this graph, will tend to give non-factorization in unpolarized cross sections.

INT
March 28, 2008

AdS/QCD
149

Stan Brodsky, SLAC

Remarkable observation at HERA

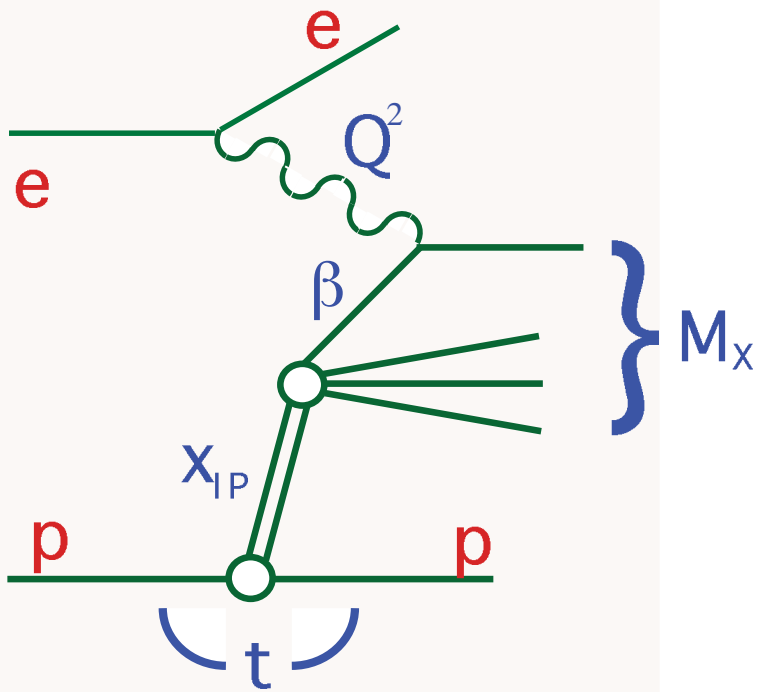

*10% to 15%
of DIS events
are
diffractive!*

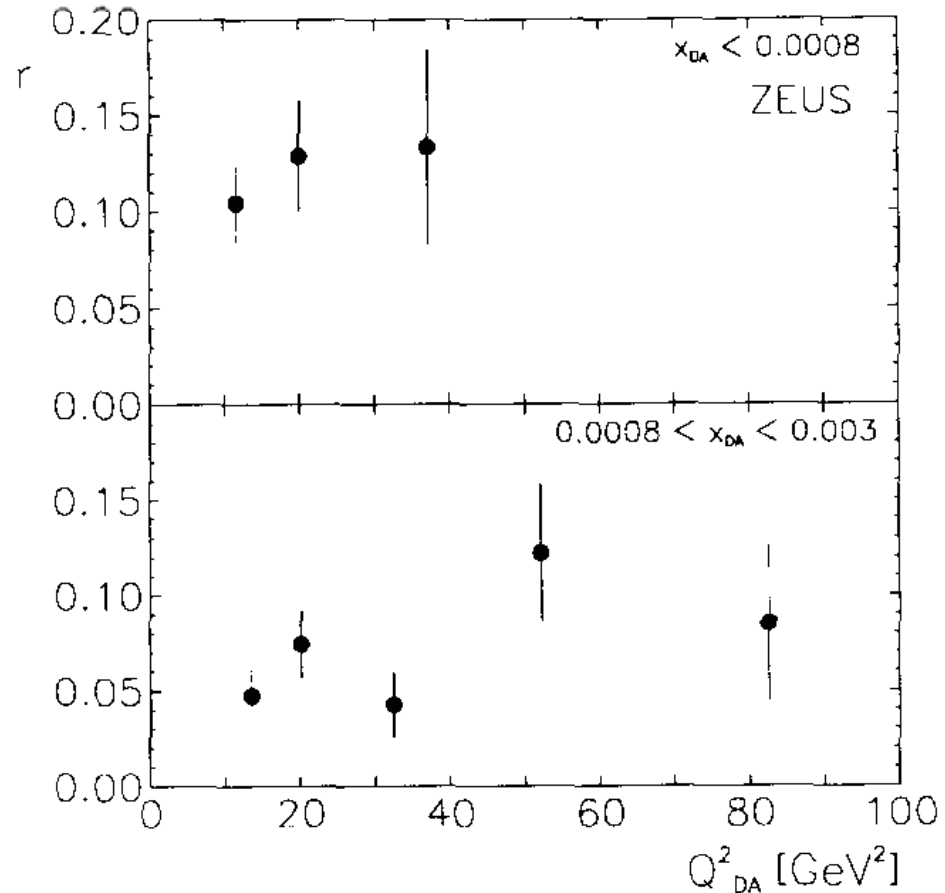

Fraction r of events with a large rapidity gap, $\eta_{\max} < 1.5$, as a function of Q_{DA}^2 for two ranges of x_{DA} . No acceptance corrections have been applied.

M. Derrick et al. [ZEUS Collaboration], Phys. Lett. B 315, 481 (1993).

DDIS

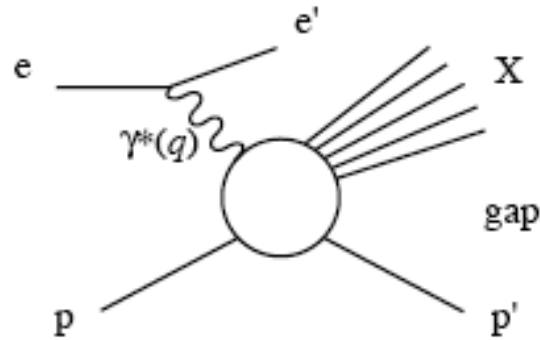

- In a large fraction ($\sim 10\text{--}15\%$) of DIS events, the proton escapes intact, keeping a large fraction of its initial momentum
- This leaves a large *rapidity gap* between the proton and the produced particles
- The t -channel exchange must be *color singlet* \rightarrow a pomeron??

Diffractive Deep Inelastic Lepton-Proton Scattering

INT
March 28, 2008

AdS/QCD
151

Stan Brodsky, SLAC

Final-State Interaction Produces Diffractive DIS

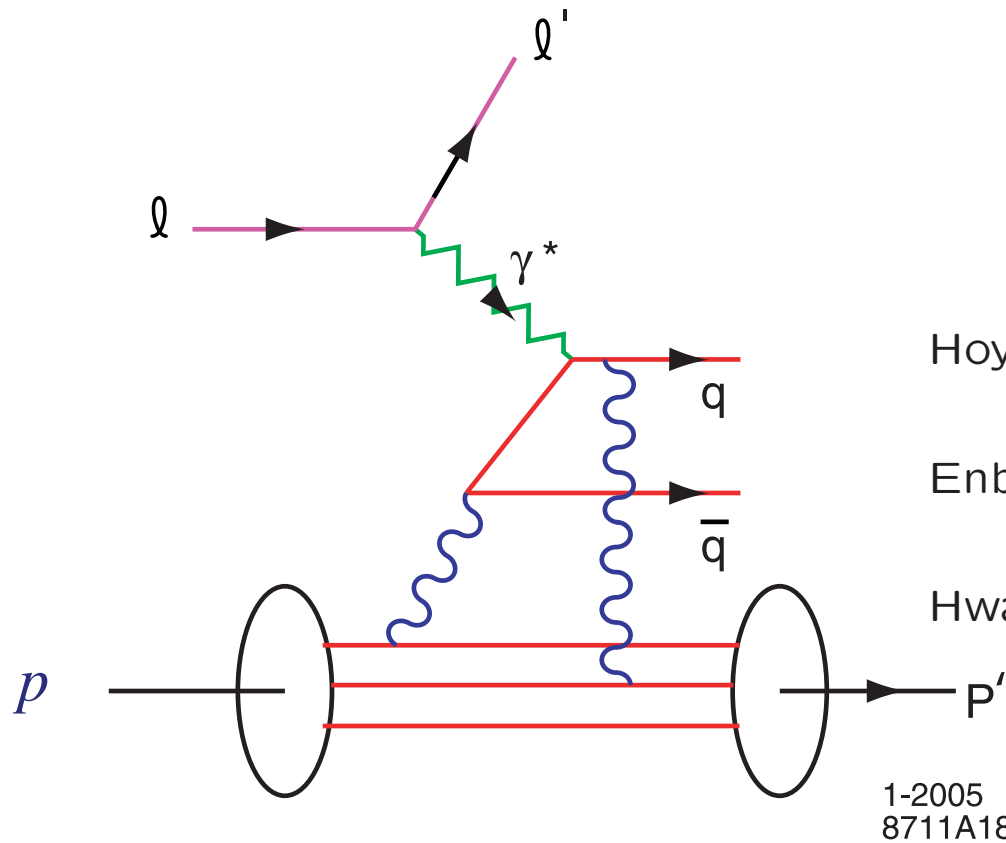

Quark Rescattering

Hoyer, Marchal, Peigne, Sannino, SJB (BHM)

Enberg, Hoyer, Ingelman, SJB

Hwang, Schmidt, SJB

Low-Nussinov model of Pomeron

INT
March 28, 2008

AdS/QCD
153

Stan Brodsky, SLAC

QCD Mechanism for Rapidity Gaps

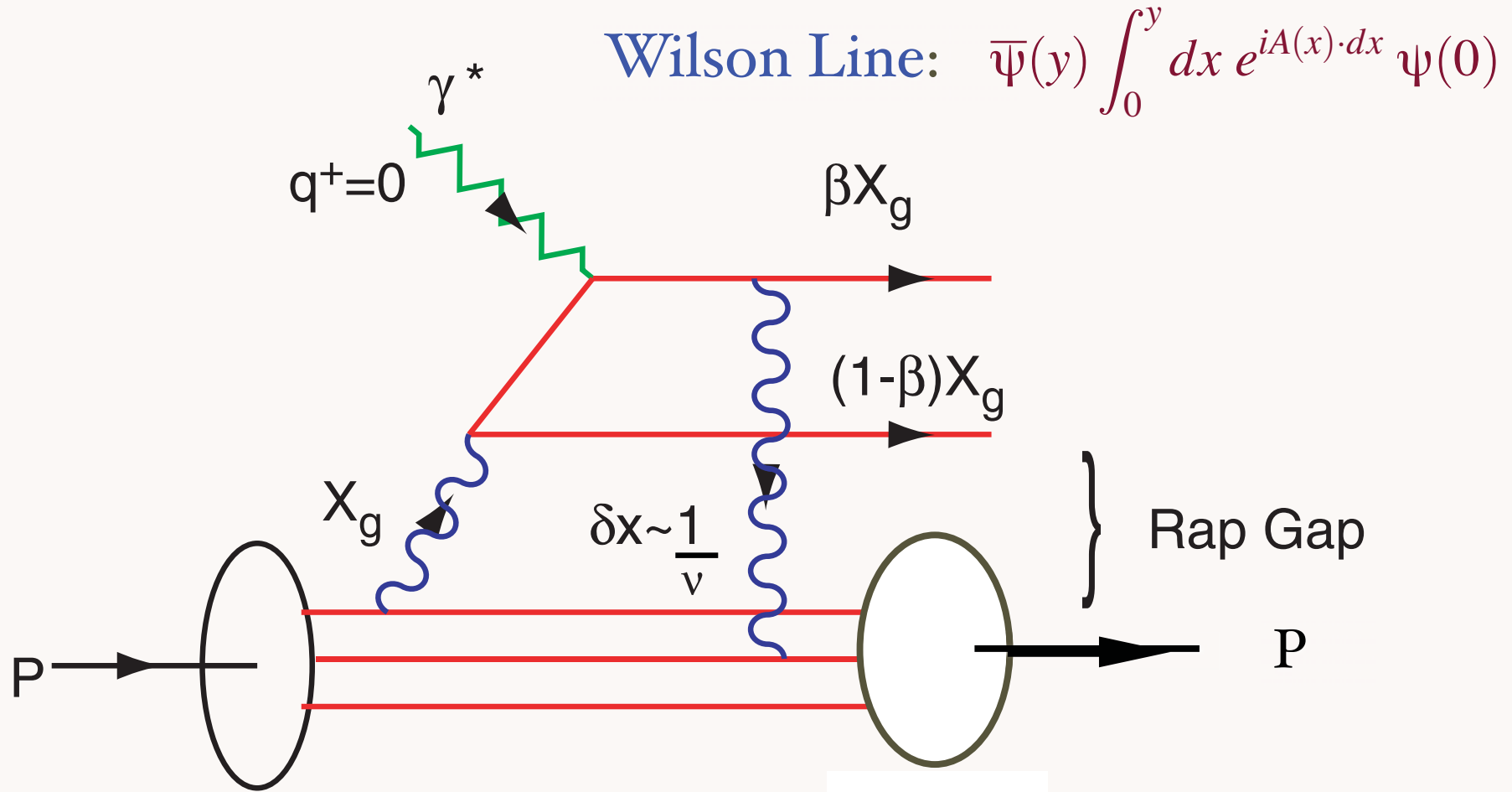

Reproduces lab-frame color dipole approach

Final State Interactions in QCD

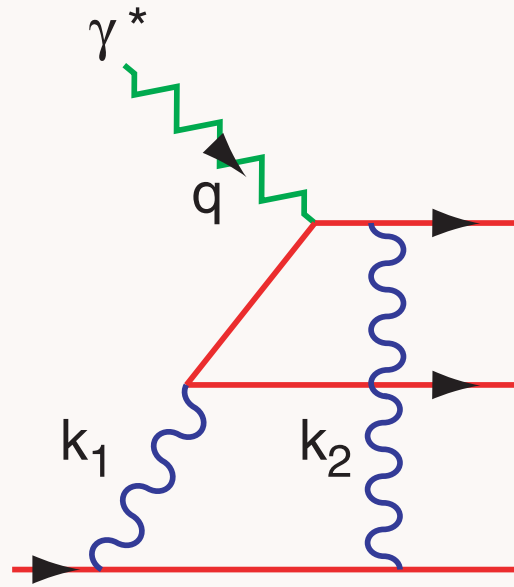

Feynman Gauge

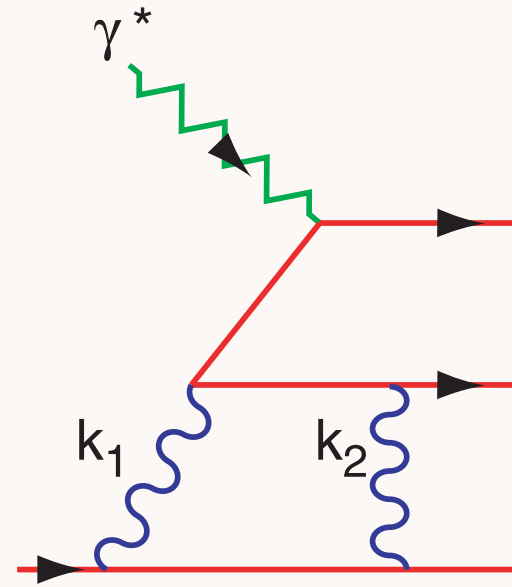

Light-Cone Gauge

Result is Gauge Independent

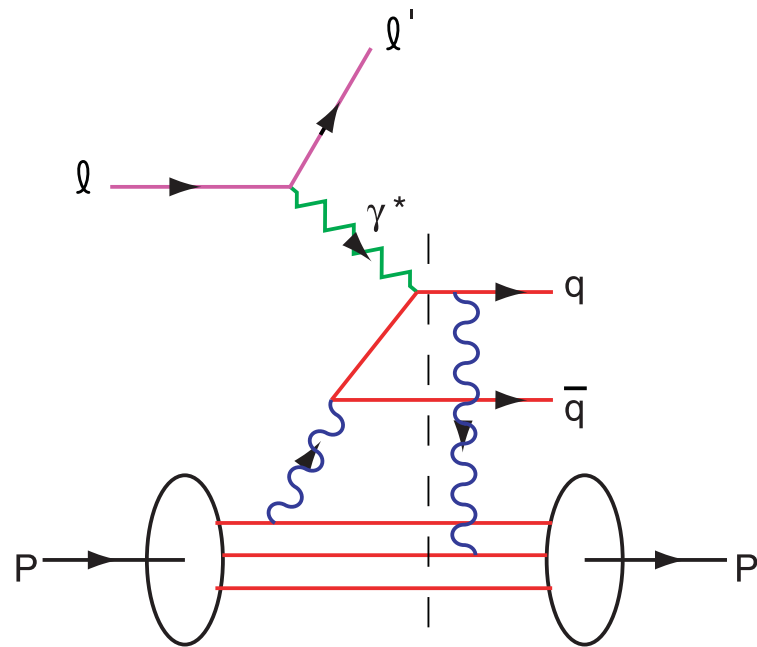

Integration over on-shell domain produces phase i

Need Imaginary Phase to Generate Pomeron

Need Imaginary Phase to Generate
T-Odd Single-Spin Asymmetry

Physics of FSI not in Wavefunction of Target

Physics of Rescattering

- Sivers Asymmetry and Diffractive DIS: New Insights into Final State Interactions in QCD
- Origin of Hard Pomeron
- Structure Functions not Probability Distributions!
- T-odd SSAs, Shadowing, Antishadowing
- Diffractive dijets/ trijets, doubly diffractive Higgs
- Novel Effects: Color Transparency, Color Opaqueness, Intrinsic Charm, Odderon

Physics of Rescattering

- Diffractive DIS
- Non-Unitary Correction to DIS: Structure functions are not probability distributions
- Nuclear Shadowing, Antishadowing- Not in Target WF
- Single Spin Asymmetries -- opposite sign in DY and DIS
- $DY \cos 2\phi$ distribution at leading twist from double ISI-- not given by PQCD factorization -- breakdown of factorization!
- Wilson Line Effects not 1 even in LCG
- Must correct hard subprocesses for initial and final-state soft gluon attachments
- Corrections to Handbag Approximation in DVCS!

Hoyer, Marchal, Peigne, Sannino, sjb

INT
March 28, 2008

AdS/QCD
158

Stan Brodsky, SLAC

“Dangling Gluons”

- Diffractive DIS
- Non-Unitary Correction to DIS: Structure functions are not probability distributions
- Nuclear Shadowing, Antishadowing
- Single Spin Asymmetries -- opposite sign in DY and DIS
- $DY \cos 2\phi$ correlation at leading twist from double ISI-- not given by standard PQCD factorization
- Wilson Line Effects persist even in LCG
- Must correct hard subprocesses for initial and final-state soft gluon attachments -- Ji gauge link, Kovchegov gauge

Bodwin, Lepage, sjb
Hoyer, Marchal, Peigne, Sannino, sjb

Light-Front QCD Phenomenology

- Hidden color, Intrinsic glue, sea, Color Transparency
- Near Conformal Behavior of LFWFs at Short Distances; PQCD constraints
- Vanishing anomalous gravitomagnetic moment
- Relation between edm and anomalous magnetic moment
- Cluster Decomposition Theorem for relativistic systems
- OPE: DGLAP, ERBL evolution; invariant mass scheme

$$|p, S_z\rangle = \sum_{n=3} \Psi_n(x_i, \vec{k}_{\perp i}, \lambda_i) |n; \vec{k}_{\perp i}, \lambda_i\rangle$$

sum over states with $n=3, 4, \dots$ constituents

The Light Front Fock State Wavefunctions

$$\Psi_n(x_i, \vec{k}_{\perp i}, \lambda_i)$$

are boost invariant; they are independent of the hadron's energy and momentum P^μ .

The light-cone momentum fraction

$$x_i = \frac{k_i^+}{p^+} = \frac{k_i^0 + k_i^z}{P^0 + P^z}$$

are boost invariant.

$$\sum_i^n k_i^+ = P^+, \quad \sum_i^n x_i = 1, \quad \sum_i^n \vec{k}_i^\perp = \vec{0}^\perp.$$

Intrinsic heavy quarks

$$\bar{u}(x) \neq \bar{d}(x)$$

Mueller: BFKL DYNAMICS

$$\bar{s}(x) \neq s(x)$$

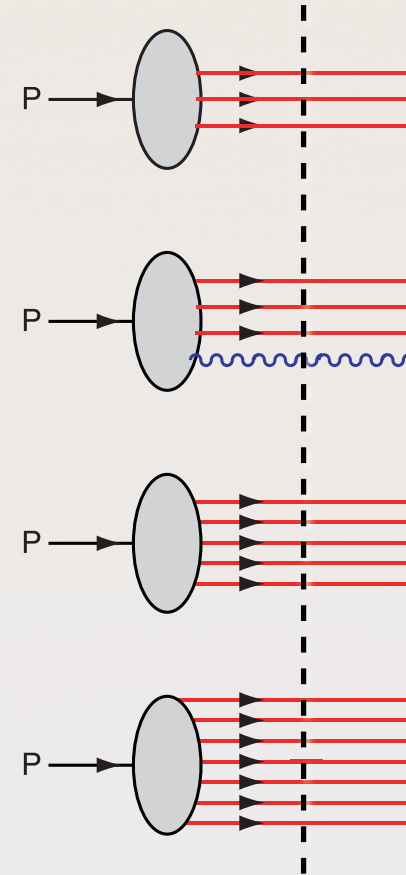

Fixed LF time

INT

March 28, 2008

AdS/QCD

I6I

Stan Brodsky, SLAC

Light Antiquark Flavor Asymmetry

- Naïve Assumption from gluon splitting:

$$\bar{d}(x) = \bar{u}(x)$$

- E866/NuSea (Drell-Yan)

$\bar{d}(x)/\bar{u}(x)$ for $0.015 \leq x \leq 0.35$

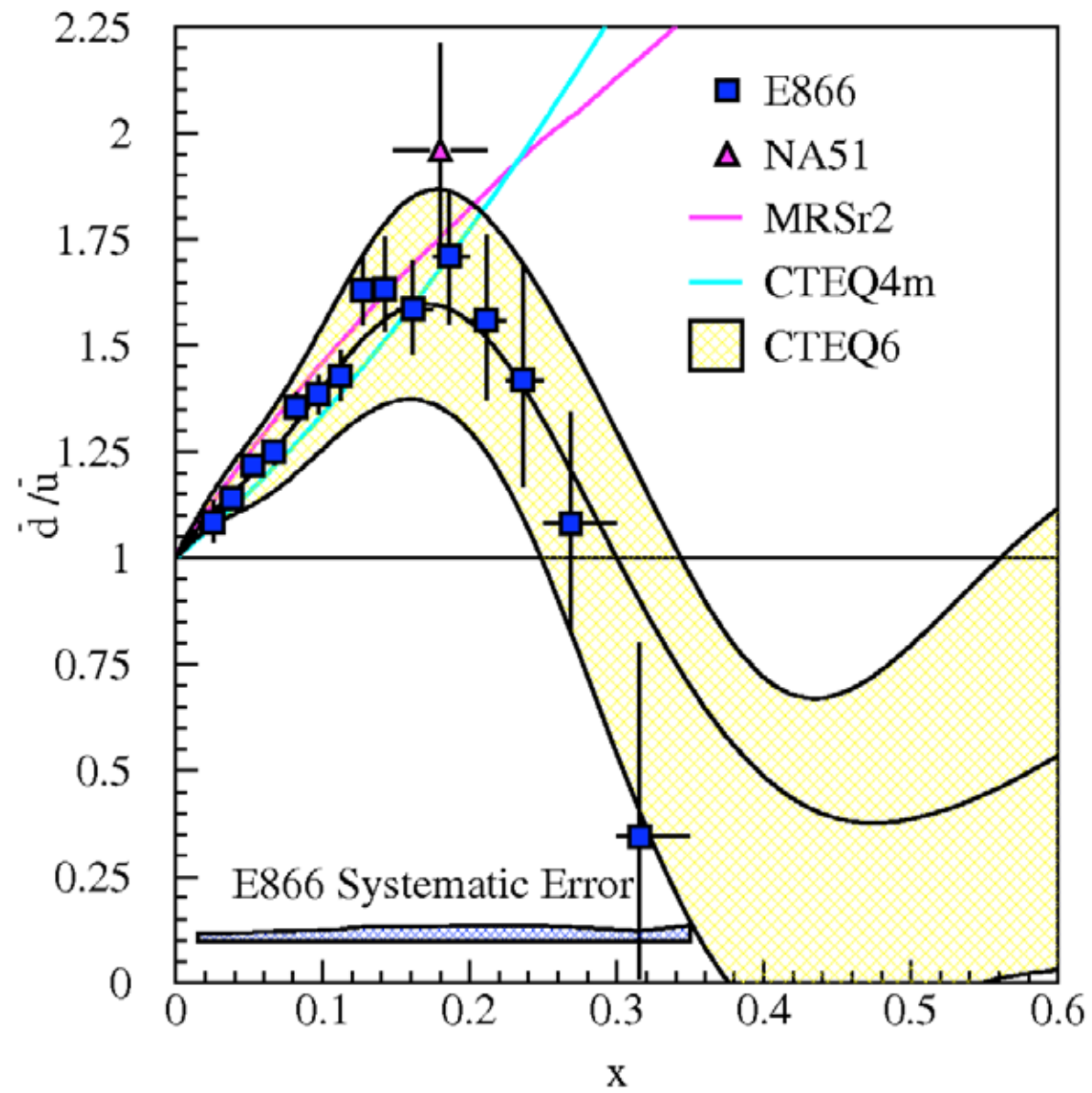

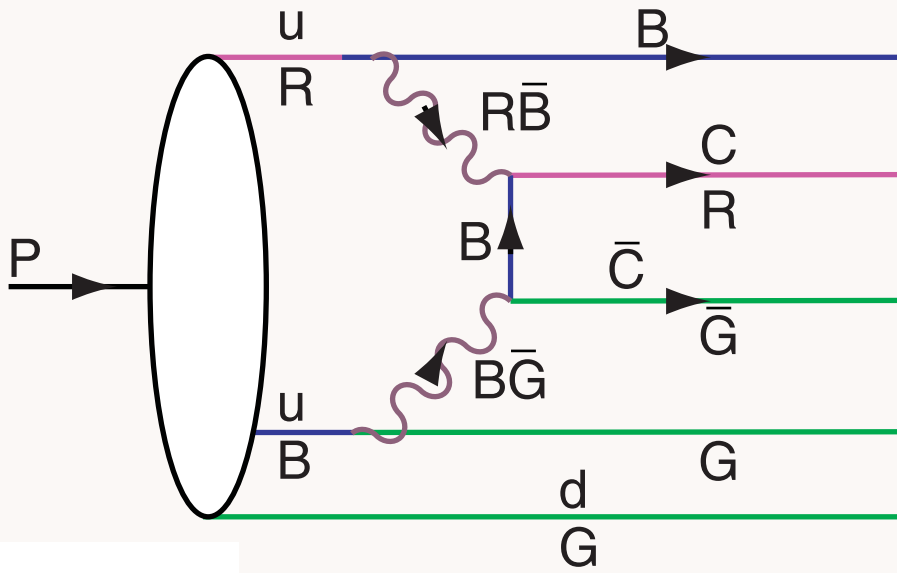

$|uudc\bar{c}\rangle$ Fluctuation in Proton

QCD: Probability $\sim \frac{\Lambda_{QCD}^2}{M_Q^2}$

$|e^+e^-\ell^+\ell^-\rangle$ Fluctuation in Positronium

QED: Probability $\sim \frac{(m_e\alpha)^4}{M_\ell^4}$

OPE derivation - M.Polyakov et al.

$$\langle p | \frac{G_{\mu\nu}^3}{m_Q^2} | p \rangle \text{ vs. } \langle p | \frac{F_{\mu\nu}^4}{m_\ell^4} | p \rangle$$

$c\bar{c}$ in Color Octet

Distribution peaks at equal rapidity (velocity)
Therefore heavy particles carry the largest momentum fractions

$$\hat{x}_i = \frac{m_{\perp i}}{\sum_j^n m_{\perp j}}$$

High x charm!

Hoyer, Peterson, Sakai, sjb

Intrinsic Heavy-Quark Fock States

- Rigorous prediction of QCD, OPE
- Color - Octet + Color - Octet Fock State!
- Probability $P_{Q\bar{Q}} \propto \frac{1}{M_Q^2}$ $P_{Q\bar{Q}Q\bar{Q}} \sim \alpha_s^2 P_{Q\bar{Q}}$ $P_{c\bar{c}/p} \simeq 1\%$
- Large Effect at high x
- Greatly increases kinematics of colliders such as Higgs production (Kopeliovich, Schmidt, Soffer, sjb)
- Severely underestimated in conventional parameterizations of heavy quark distributions (Pumplin, Tung)
- Many empirical tests

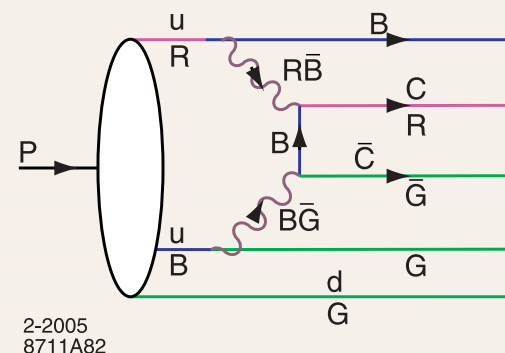

Measure $c(x)$ in Deep Inelastic Lepton-Proton Scattering

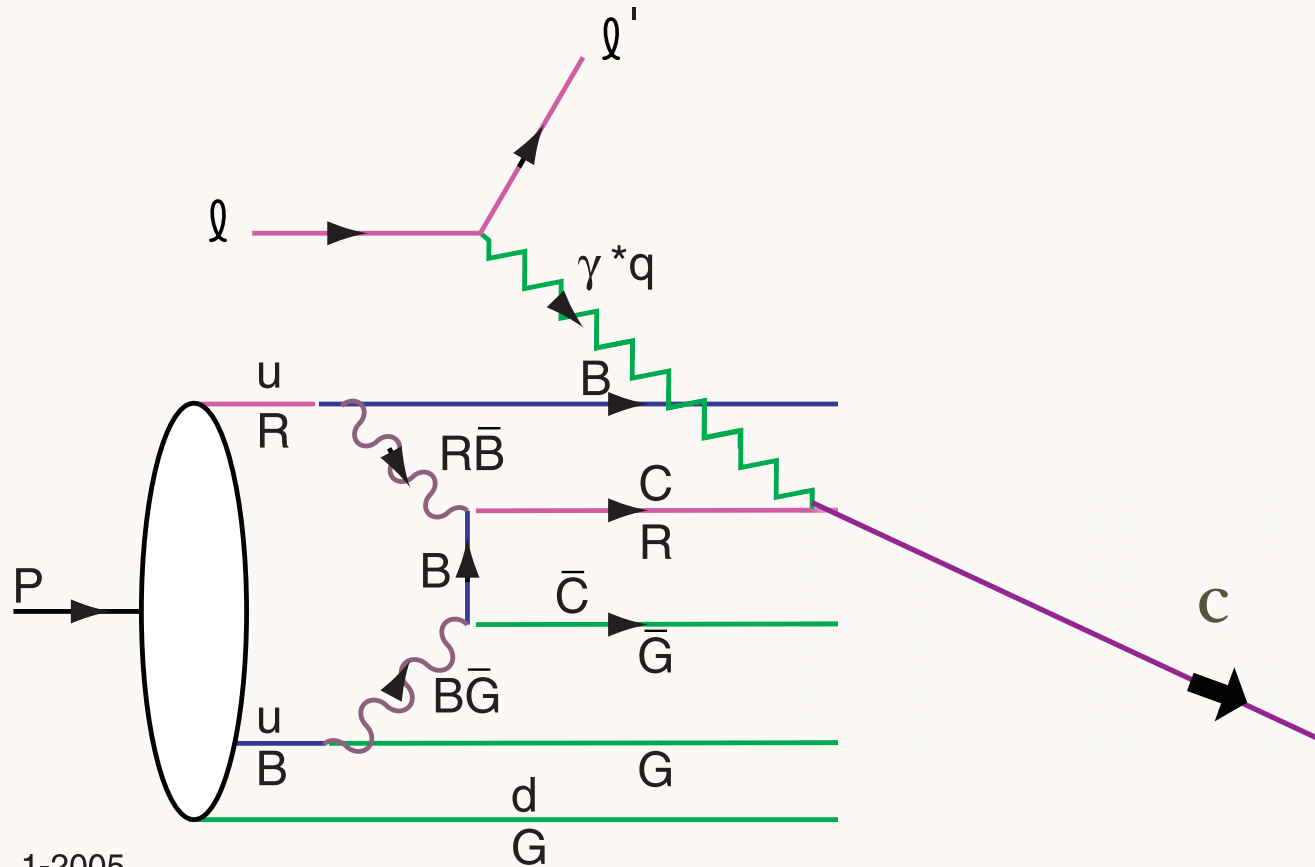

1-2005
8711A83

Hoyer, Peterson, SJB

INT
March 28, 2008

AdS/QCD
165

Stan Brodsky, SLAC

Measurement of Charm Structure Function

J. J. Aubert et al. [European Muon Collaboration], "Production Of Charmed Particles In 250-GeV Mu+ - Iron Interactions," Nucl. Phys. B 213, 31 (1983).

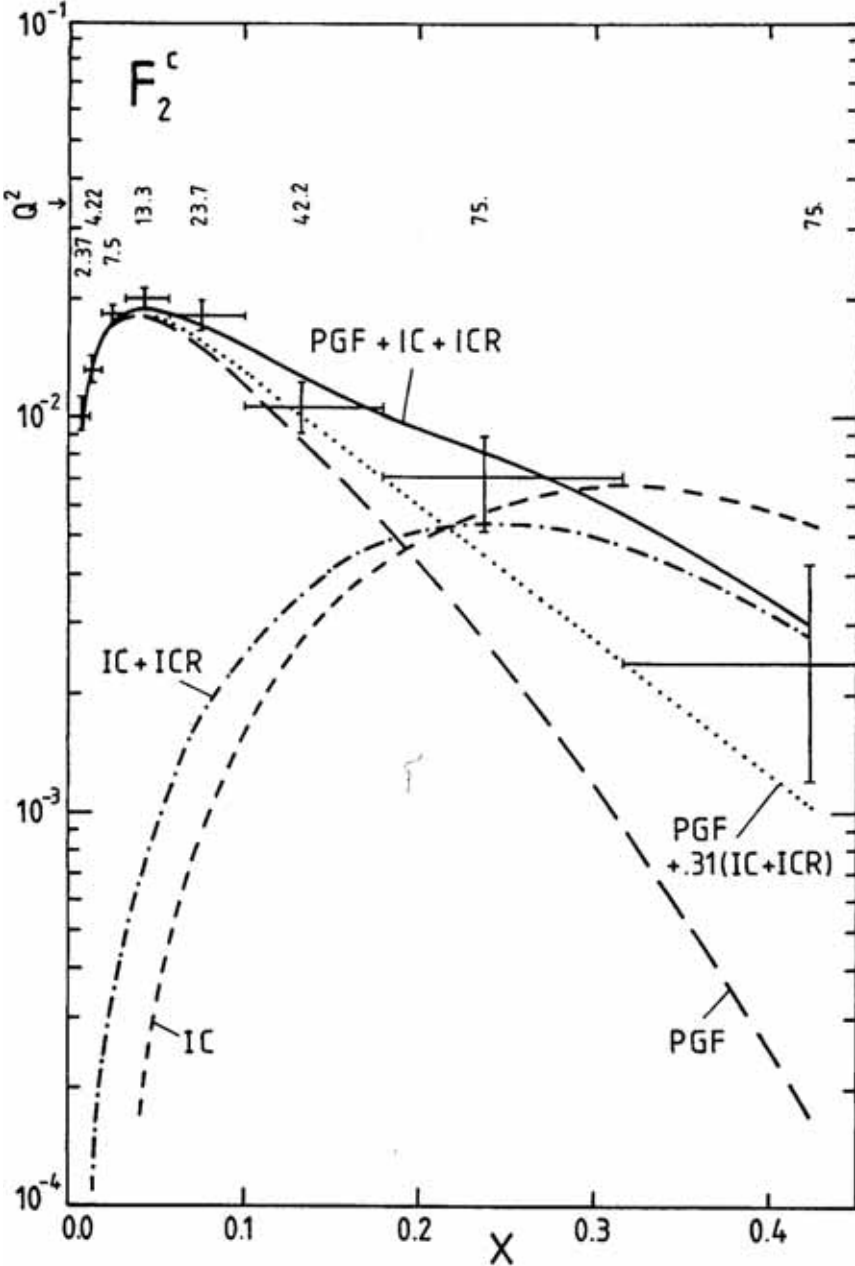

First Evidence for Intrinsic Charm

factor of 30!

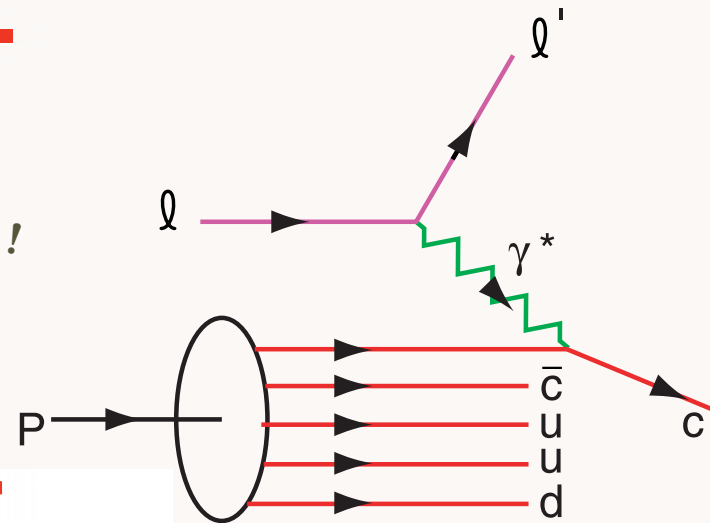

DGLAP / Photon-Gluon Fusion: factor of 30 too small

INT
March 28, 2008

AdS/QCD
166

Stan Brodsky, SLAC

- EMC data: $c(x, Q^2) > 30 \times \text{DGLAP}$
 $Q^2 = 75 \text{ GeV}^2, x = 0.42$
- High x_F $pp \rightarrow J/\psi X$
- High x_F $pp \rightarrow J/\psi J/\psi X$
- High x_F $pp \rightarrow \Lambda_c X$
- High x_F $pp \rightarrow \Lambda_b X$
- High x_F $pp \rightarrow \Xi(ccd)X$ (SELEX)

Novel Heavy Flavor Physics

- LFWFS -- remarkable model from AdS/CFT
- AdS/CFT: Hadron Spectra and Dynamics, Counting Rules
- Intrinsic Charm and Bottom: rigorous prediction of QCD
- B decays: Many Novel QCD Effects
- Exclusive Channels: QCD at Amplitude Level
- Test B-analyses in other hard exclusive reactions, such as two-photon reactions
- Initial and Final State QCD Interactions -- Breakdown of QCD Factorization in Heavy Quark Hadroproduction!
- Renormalization scale not arbitrary

String Theory



AdS/CFT

Mapping of Poincare' and Conformal $SO(4,2)$ symmetries of 3+1 space to AdS5 space

Goal: First Approximant to QCD

Counting rules for Hard Exclusive Scattering
Regge Trajectories
QCD at the Amplitude Level

AdS/QCD

Conformal behavior at short distances + Confinement at large distance

Semi-Classical QCD / Wave Equations

Holography

Boost Invariant 3+1 Light-Front Wave Equations

$J=0, 1, 1/2, 3/2$ plus L

Integrable!

Hadron Spectra, Wavefunctions, Dynamics

Light-Front Quantization of the Standard Model

$$\phi(x) = \frac{1}{\sqrt{2}} v + \varphi = \frac{1}{\sqrt{2}} ([v + h(x)] + i\eta(x))$$

No Higgs VEV!

Goldstone field

$k^+ = 0$ zero mode

A Unitary and renormalizable theory of the standard model in ghost free light cone gauge.

P. Srivastava and sjb

Phys.Rev.D66:045019,2002.

hep-ph/0202141

Decoupling of gravity to the Higgs zero mode

INT
March 28, 2008

AdS/QCD
170

Stan Brodsky, SLAC

New Perspectives on QCD Phenomena from AdS/CFT

- **AdS/CFT**: Duality between string theory in Anti-de Sitter Space and Conformal Field Theory
- New Way to Implement Conformal Symmetry
- Holographic Model: Conformal Symmetry at Short Distances, Confinement at large distances
- Remarkable predictions for hadronic spectra, wavefunctions, interactions
- AdS/CFT provides novel insights into the quark structure of hadrons

Outlook

- Only one scale Λ_{QCD} determines hadronic spectrum (slightly different for mesons and baryons).
- Ratio of Nucleon to Delta trajectories determined by zeroes of Bessel functions.
- String modes dual to baryons extrapolate to three fermion fields at zero separation in the AdS boundary.
- Only dimension 3, $\frac{9}{2}$ and 4 states $\bar{q}q$, qqq , and gg appear in the duality at the classical level!
- Non-zero orbital angular momentum and higher Fock-states require introduction of quantum fluctuations.
- Simple description of space and time-like structure of hadronic form factors.
- Dominance of quark-interchange in hard exclusive processes emerges naturally from the classical duality of the holographic model. Modified by gluonic quantum fluctuations.
- Covariant version of the bag model with confinement and conformal symmetry.

A Few References: Bottom-up-Approach

- Derivation of dimensional counting rules of hard exclusive glueball scattering in AdS/CFT:
Polchinski and Strassler, hep-th/0109174.
- Deep inelastic scattering in AdS/CFT:
Polchinski and Strassler, hep-th/0209211.
- Unified description of the soft and hard pomeron in AdS/CFT:
Brower, Polchinski, Strassler and Tan, hep-th/0603115.
- Hadron couplings and form factors in AdS/CFT:
Hong, Yoon and Strassler, hep-th/0409118.
- Low lying meson spectra, chiral symmetry breaking and hadron couplings in AdS/QCD (Emphasis on axial and vector currents)
Erlich, Katz, Son and Stephanov, hep-ph/0501128,
Da Rold and Pomarol, hep-ph/0501218, hep-ph/0510268.

- Gluonium spectrum (top-bottom):

Csaki, Ooguri, Oz and Terning, hep-th/9806021; de Mello Kock, Jevicki, Mihailescu and Nuñez, hep-th/9806125; Csaki, Oz, Russo and Terning, hep-th/9810186; Minahan, hep-th/9811156; Brower, Mathur and Tan, hep-th/0003115, Caceres and Nuñez, hep-th/0506051.

- D3/D7 branes (top-bottom):

Karch and Katz, hep-th/0205236; Karch, Katz and Weiner, hep-th/0211107; Kruczenski, Mateos, Myers and Winters, hep-th/0311270; Sakai and Sonnenschein, hep-th/0305049; Babington, Erdmenger, Evans, Guralnik and Kirsch, hep-th/0312263; Nuñez, Paredes and Ramallo, hep-th/0311201; Hong, Yoon and Strassler, hep-th/0312071; hep-th/0409118; Kruczenski, Pando Zayas, Sonnenschein and Vaman, hep-th/0410035; Sakai and Sugimoto, hep-th/0412141; Paredes and Talavera, hep-th/0412260; Kirsh and Vaman, hep-th/0505164; Apreda, Erdmenger and Evans, hep-th/0509219; Casero, Paredes and Sonnenschein, hep-th/0510110.

- Other aspects of high energy scattering in warped spaces:

Giddings, hep-th/0203004; Andreev and Siegel, hep-th/0410131; Siopsis, hep-th/0503245.

- Strongly coupled quark-gluon plasma ($\eta/s = 1/4\pi$):

Policastro, Son and Starinets, hep-th/0104066; Kang and Nastase, hep-th/0410173 ...

- Counting rules, low lying meson and baryon spectra and form factors in AdS/CFT, holographic light front representation and mapping of string amplitudes to light-front wavefunctions, integrability and stability of AdS/CFT equations (Emphasis on hadronic quark constituents)

Brodsky and GdT, hep-th/0310227, hep-th/0409074, hep-th/0501022, hep-ph/0602252, 0707.3859 [hep-ph], 0709.2072 [hep-ph].

1. **“Light-Front Dynamics and AdS/QCD: The Pion Form Factor in the Space- and Time-Like Regions”**
S. J. Brodsky and G. F. de Teramond
arXiv:0707.3859 [hep-ph]
SLAC-PUB-12554(2007) (Submitted to Phys.Rev.D)
2. **“AdS/CFT and QCD”**
S. J. Brodsky and G. F. de Teramond
arXiv:hep-th/0702205
SLAC-PUB-12361(2007)
Invited talk at 2006 International Workshop on the Origin of Mass and Strong Coupling Gauge Theories (SCGT 06), Nagoya, Japan, 21-24 Nov 2006
3. **“Hadronic spectra and light-front wavefunctions in holographic QCD”**
S. J. Brodsky and G. F. de Teramond
Phys. Rev. Lett. **96**, 201601 (2006) [arXiv:hep-ph/0602252]
4. **“Advances in light-front quantization and new perspectives for QCD from AdS/CFT”**
S. J. Brodsky and G. F. de Teramond
Nucl. Phys. Proc. Suppl. **161**, 34 (2006)
Invited talk at Workshop on Light-Cone QCD and Nonperturbative Hadron Physics 2005 (LC 2005), Cairns, Queensland, Australia, 7-15 Jul 2005
5. **“Hadron spectroscopy and wavefunctions in QCD and the AdS/CFT correspondence”**
S. J. Brodsky and G. F. de Teramond
AIP Conf. Proc. **814**, 108 (2006) [arXiv:hep-ph/0510240]
Invited talk at 11th International Conference on Hadron Spectroscopy (Hadron05), Rio de Janeiro, Brazil, 21-26 Aug 2005

6. **“Applications of AdS/CFT duality to QCD”**
S. J. Brodsky and G. F. de Teramond
Int. J. Mod. Phys. A **21**, 762 (2006) [arXiv:hep-ph/0509269]
Invited talk at International Conference on QCD and Hadronic Physics, Beijing, China, 16-20 Jun 2005
7. **“Nearly conformal QCD and AdS/CFT”**
G. F. de Teramond and S. J. Brodsky
arXiv:hep-ph/0507273
SLAC-PUB-11375(2005)
Presented at 1st Workshop on Quark-Hadron Duality and the Transition to pQCD, Frascati, Rome, Italy, 6-8 Jun 2005
8. **“The hadronic spectrum of a holographic dual of QCD”**
G. F. de Teramond and S. J. Brodsky
Phys. Rev. Lett. **94**, 201601 (2005) [arXiv:hep-th/0501022]
9. **“Baryonic states in QCD from gauge / string duality at large $N(c)$ ”**
G. F. de Teramond and S. J. Brodsky
arXiv:hep-th/0409074
SLAC-PUB-10693(2004)
Presented at ECT Workshop on Large N_c QCD 2004, Trento, Italy, 5-9 Jul 2004*
10. **“Light-front hadron dynamics and AdS/CFT correspondence”**
S. J. Brodsky and G. F. de Teramond
Phys. Lett. B **582**, 211 (2004) [arXiv:hep-th/0310227]