

THE ALIGNMENT OF THE ADVANCED PHOTON SOURCE AT ARGONNE NATIONAL LABORATORY*

Horst Friedsam
Argonne National Laboratory, Argonne, Illinois, USA

1. INTRODUCTION

Currently the Advanced Photon Source (APS) is under construction at the Argonne National Laboratory. The APS is a 7-GeV synchrotron light source which will be used for basic research in material science, chemistry, physics, biology, and medicine to name a few of the participating disciplines. The commissioning phase for the APS is planned to start at the beginning of 1995. This paper describes the general parameters of the Advanced Photon Source, the required survey and alignment tolerances, and the alignment concept and instrumentation used to position storage ring beam components.

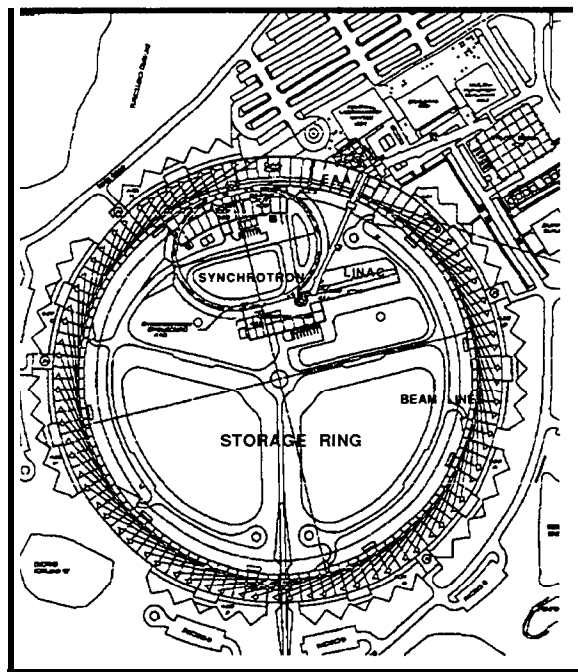

Fig. 1 APS site overview

2. APS DESIGN PARAMETERS

The APS consists of a 70m-long linear accelerator, a positron accumulator ring (PAR), a synchrotron ring with a circumference of 368m, and the storage ring with a circumference of 1104m (Fig. 1). The 40m electron linac uses 200 MeV electrons for the production of positrons. In the 30m-long linear accelerator section following the electron linac the particles gain a mass of 450 MeV before entering the positron accumulator ring. From there the beam is injected into the booster synchrotron which accelerates the positrons from 450 MeV to 7 GeV before entering the storage ring. The storage ring can accommodate up to 68 experimental beamlines. Thirty-two of these beamlines will be instrumented in the first phase.

* Work supported by US DOE Office of Basic Energy Sciences under Contract No. W-31-109-ENG-38.

3. ALIGNMENT TOLERANCES

In order to achieve a successful startup of the APS, the following global and relative alignment tolerances, defined by each of the ring managers, must be met.

3.1 Global tolerances

The global placement tolerances require the positioning of each beam component in absolute space within a vertical and horizontal envelope of $\pm 5\text{mm}$ of the ideal position.

The circumference of the storage ring cannot deviate from its design value by more than $\pm 20\text{mm}$.

The roll of each quadrupole, sextupole, and dipole has to be set within $\pm 0.5\text{mrad}$.

3.2 Relative tolerances

The relative alignment between beam elements depends on the type of component and its location in the accelerator system. The following tables summarize the required alignment tolerances for dipoles (Table 1) and quadrupoles and sextupoles (Table 2) for each accelerator subsystem. The maximum tolerable displacement horizontal, vertical and in beam direction is shown as well as the tolerance for the roll angle of each component [1].

Table 1

Maximum tolerable displacement for dipoles relative to adjacent beam components

| | Horizontal/Vertical | In Beam Direction | Roll Angle |
|--------------|---------------------|--------------------|----------------------|
| PAR | $\pm 0.5\text{mm}$ | $\pm 1\text{mm}$ | $\pm 0.5\text{mrad}$ |
| Synchrotron | $\pm 0.5\text{mm}$ | $\pm 1\text{mm}$ | $\pm 1\text{mrad}$ |
| Storage ring | $\pm 0.2\text{mm}$ | $\pm 0.5\text{mm}$ | $\pm 0.5\text{mrad}$ |

Table 2

Maximum tolerable displacements for quadrupoles and sextupoles relative to adjacent beam components

| | Horizontal/Vertical | In Beam Direction | Roll Angle |
|--------------|---------------------|-------------------|----------------------|
| Linac | $\pm 0.5\text{mm}$ | $\pm 1\text{mm}$ | $\pm 5\text{mrad}$ |
| PAR | $\pm 0.5\text{mm}$ | $\pm 1\text{mm}$ | $\pm 5\text{mrad}$ |
| Synchrotron | $\pm 0.3\text{mm}$ | $\pm 1\text{mm}$ | $\pm 0.5\text{mrad}$ |
| Storage ring | $\pm 0.15\text{mm}$ | $\pm 1\text{mm}$ | $\pm 0.5\text{mrad}$ |

4. APS COORDINATE SYSTEM

The geodetic reference surface [2] used for the APS is a locally best-fitting Gaussian sphere of Clark's ellipsoid at 41.704° , the approximate geographic latitude of the APS site. The Gaussian sphere is a third-order approximation of the local gravity field at the APS site [3]. The lattice coordinate system describing the ideal position of each beam component is a rectangular right-handed coordinate system with the same origin and orientation as the geodetic coordinate system tangential to the Gaussian sphere at the origin. The rectangular system gradually departs in elevation from the geodetic system with increasing distance from the origin. For the storage ring, with a radius of about 175m, this deviation amounts to 2.4 mm. This systematic effect is taken into account for the positioning of all beam components of the accelerator. The ideal floor elevation for the APS is defined at 226.7712 m above mean sea level. The beam height is located 1.4m above the ideal floor elevation.

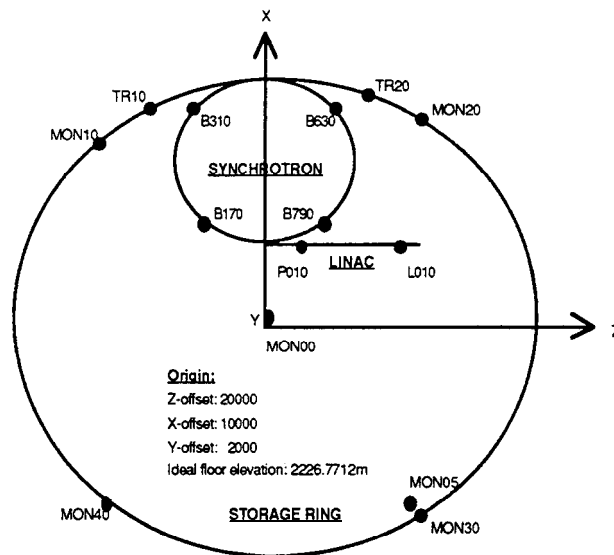

Fig. 2 APS coordinate system

The local geodetic coordinate system for the APS is defined as follows (Fig. 2):

- The origin of the coordinate system is at the center of the storage ring represented by MON00.
- The positive Z-axis is defined parallel to the direction of the linac.
- The X-axis is perpendicular to Z forming a right-handed coordinate system.
- The Y-axis is parallel to the gravity vector at MON00.

5. ALIGNMENT CONCEPT

5.1 Primary control network

The primary control network, which ensures the correct location and orientation of the accelerator subsystems to each other, consists of two concrete monuments embedded in bedrock. MON00 defines the center of the storage ring and MON05 the orientation of the primary control network. Besides these two monuments, provisions are made for two connections to the secondary control network in the linac, four connections to the control network in the booster synchrotron, and four connections to the storage ring. Two additional temporary connections for the storage ring tunnel (TR10, TR20) were only accessible during the initial construction phase.

5.2 Secondary control network

The secondary control network consists of braced quadrilaterals through the tunnel of each accelerator subsystem. The orientation of the secondary control network is determined by the connection points of the primary network. The tunnel width and curvature determine the ratio of the longest to shortest side of the quadrilateral; these are usually not favorable in terms of error propagation. For the storage ring, we were fortunate to be able to expand the control network out to the experiment hall floor (Fig. 3). Each ratchet wall of the storage ring has a removable shielding door which permits lines of sight between the control network inside the storage ring tunnel and the experiment hall. The control network for the experiment hall is constructed in such a way that two control points, also visible from the storage ring tunnel, are placed along future experimental beamlines. This expansion improves the network geometry and provides the necessary control points for the experimental beamlines, thus reducing shutdown time in the future when new beamlines are constructed. In general, the secondary

network will be used for the global positioning of all beam components in each accelerator subsystem. The control network is based on floor monuments which can hold a standard Taylor Hobbson ball as a target.

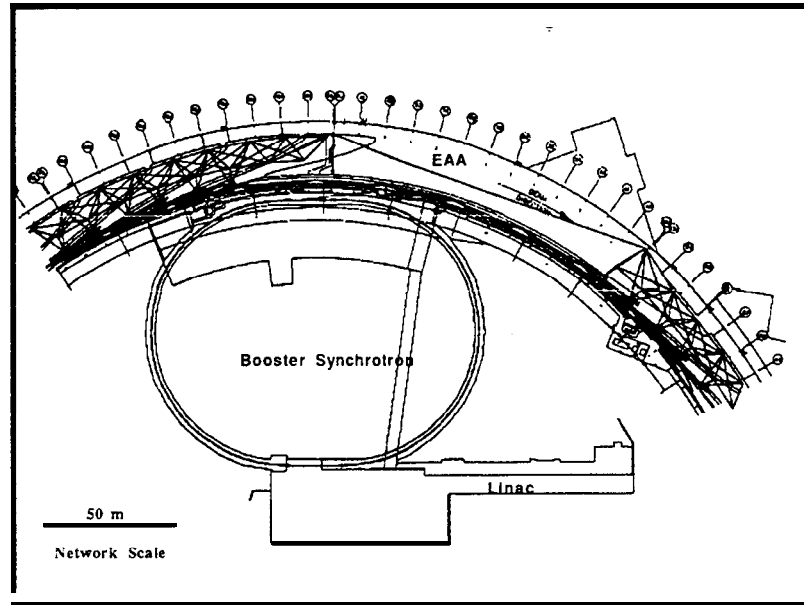

Fig. 3 Storage ring and experiment hall control network

5.3 Component fiducialization and girder assembly

Each beam component has two fiducial cups welded on top of the laminations, close to the mechanical centerline, for use in positioning (Fig. 4). Regular Taylor Hobbson balls, with either an inserted retro reflector or a cross hair, are used as targets for these fiducial cups. The roll of beam components is determined by a level bridge that registers in the grooves of the magnet laminations. During the magnet mapping process the location of each fiducial cup is determined using a Taylor Hobbson ball with a photo-sensitive quad-cell. When the optimum magnetic properties are reached, a laser beam parallel to the magnetic axis strikes the photo sensor which records the dx and dy readings for each fiducial. At the same time the roll of the component is measured. The distance between two fiducials is determined by caliper measurements. During the preassembly of beam components on girders these values are taken into account in order to position each element relative to the adjacent beam component to within $\pm 0.15\text{mm}$ using tooling bars and optical tooling techniques (Fig. 5).

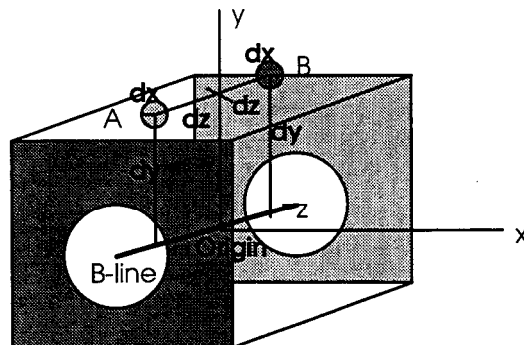

Fig. 4 Magnet fiducial locations

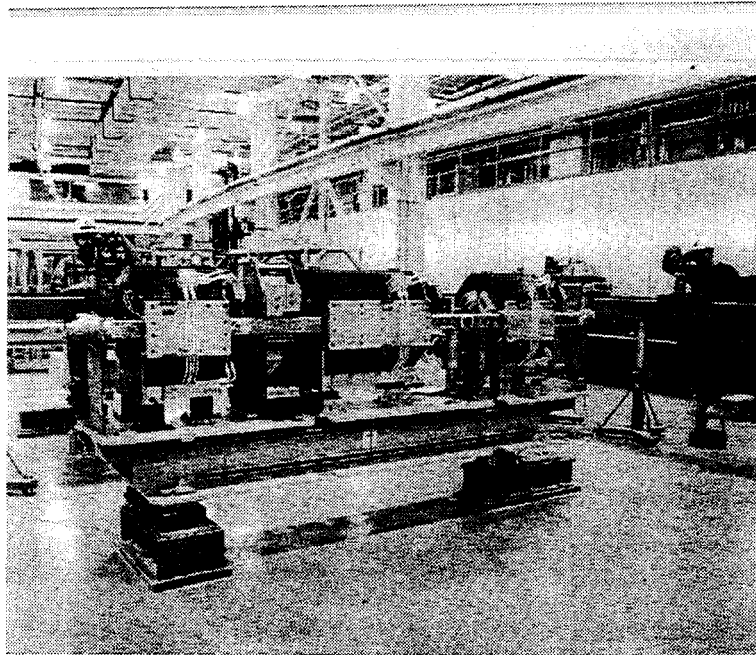

Fig. 5 EAA girder assembly

5.4 Positioning girders in the tunnel

After the beam components have been securely locked in place on the girder, the assembly is transported into the tunnel to be placed on girder pedestals that have been aligned to $\pm 1\text{mm}$ in position and $\pm 0.3\text{mm}$ in elevation. The girder will be positioned with the help of a laser tracker using one fiducial of the first and last beam element on the girder. This technique avoids the accumulation of errors as beam components are used directly to position the girder. The laser tracker's advantage over the usual alignment procedure is in its ability to survey the actual position and align the girder instantaneously in one step. The position of the laser tracker with respect to the control network can easily be determined by a three-dimensional resection using several control points. Tests have shown that the position accuracy of the laser tracker is on the order of the position accuracy of the control network.

The ideal position of each fiducial can be calculated. The difference between the actual measured fiducial position and the ideal position can be displayed on the monitor. During the alignment step these differences have to be set to zero by moving the girder assembly. After this task is accomplished, all other fiducials of the girder assembly will be checked for eventual displacements from their ideal position. The elevation of each girder will be set with conventional differential leveling because the accuracy of the laser tracker for this dimension is not sufficient. This step can only be as accurate as the estimated accuracy of the control network. Therefore a smoothing step for girders independent of the control network is required.

5.5 Girder smoothing

Assuming that the internal alignment of beam components is undisturbed after the girder has been transported into the storage ring and placed, only girders (and not beam components) have to be part of the beamline smoothing process. In this step the control network is abandoned. Using the Ecartometer for offset measurements in conjunction with a laser tracker for distance measurements between fiducials, the relative alignment between girders will be determined using principal curve analysis [4-5], a general three-dimensional smoothing algorithm developed for smoothing beamlines of the Stanford Linear Collider.

5.6 Quality control survey

In order to ensure the correct position of each girder after the previous smoothing process a second set of measurements will be taken. Depending upon the results of these measurements, further girder alignment may be required in which case a third set of measurement would become necessary for quality assurance.

5.7 Continuous settlement control

Currently efforts are underway to implement a hydrostatic leveling system (HLS) on girders in the storage ring [6]. The continuous access to the data produced by the HLS would provide instantaneous settlement information and the opportunity to correct large elevation changes which would disturb the relative girder alignment.

6. ALIGNMENT RESULTS

So far, results of the primary control network and parts of the secondary control network are available. At the time of writing this paper only small quantities of beam components are on hand and no girder has been placed in the tunnel.

The primary network was measured in November of 1992 using Mekometer distance measurements only. The resulting one sigma absolute error ellipses for all primary control network points are in the range of $\pm 0.3\text{mm}$ (Fig. 6) [7].

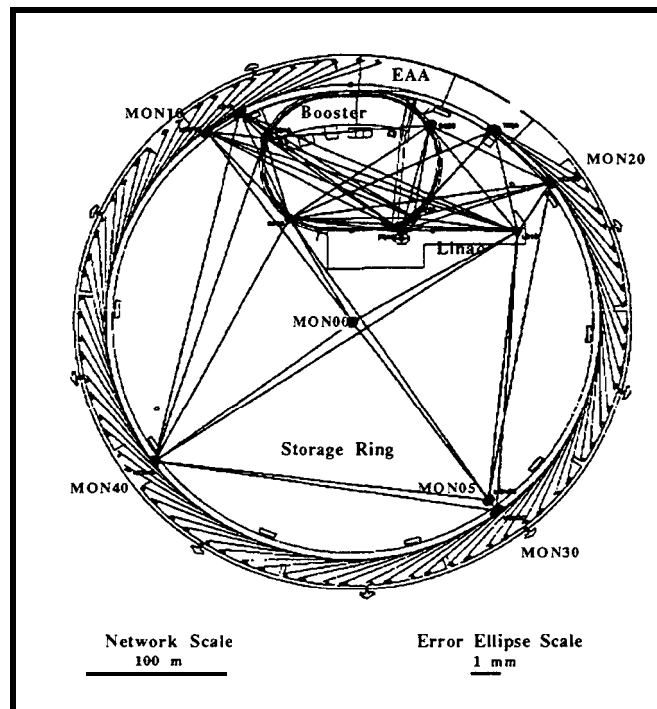

Fig. 6 Primary control network

The secondary control networks for the linac, PAR, booster synchrotron, and half of the storage ring have been finished (Fig. 7-9). The measurements included Mekometer distances and direction sets using Wild T3000 theodolites. Elevations of the three-dimensional control network points are obtained using a Wild N3 bubble level in conjunction with half centimeter graduated level rods. The results for the network control points in elevation are $\pm 0.1\text{mm}$ and

$\pm 0.3\text{mm}$ for the position in the one sigma range. For the data collection and analysis GEONET, a data management package developed for the alignment of the Stanford Linear Collider is used [8].

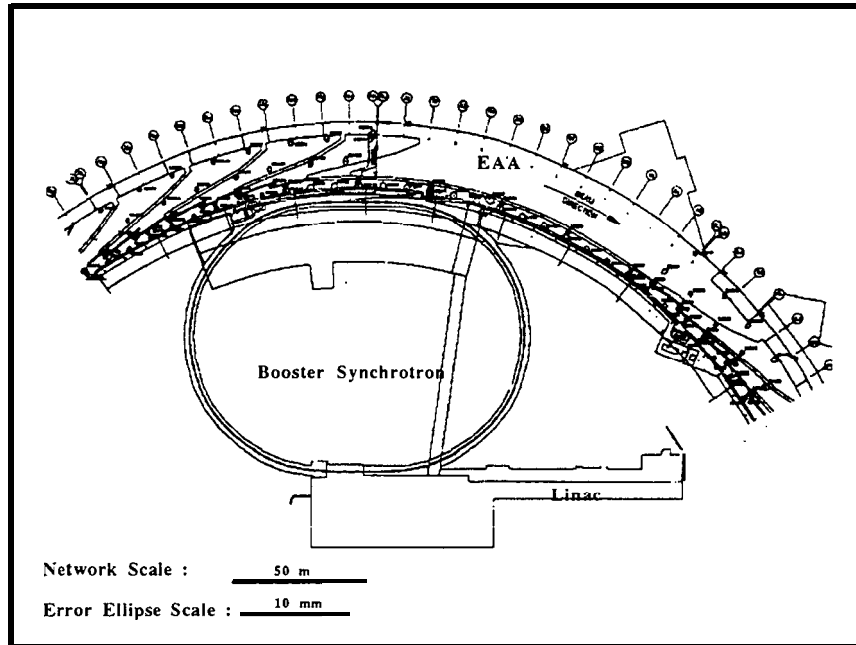

Fig. 7 Storage ring control network

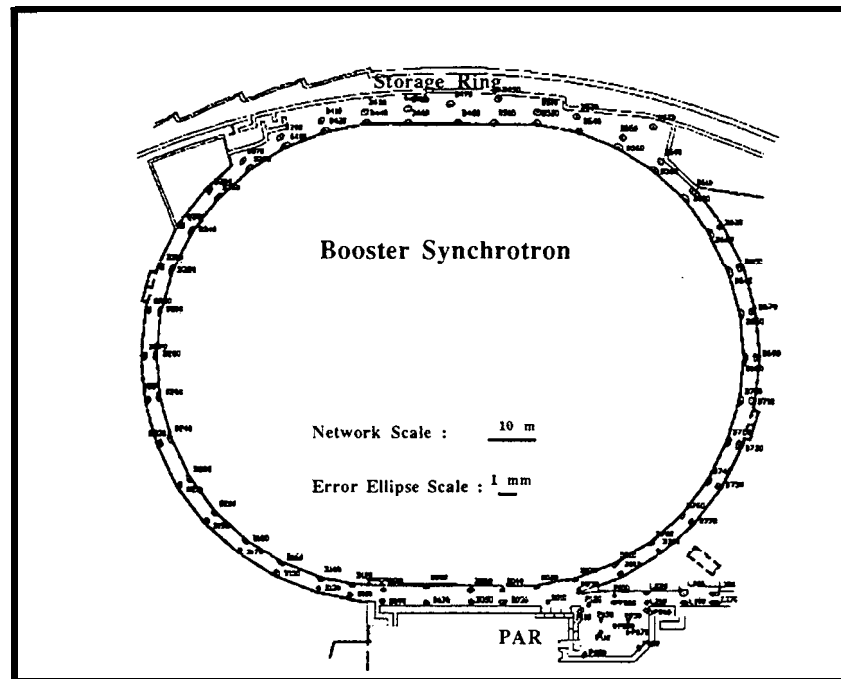

Fig. 8 Booster synchrotron control network

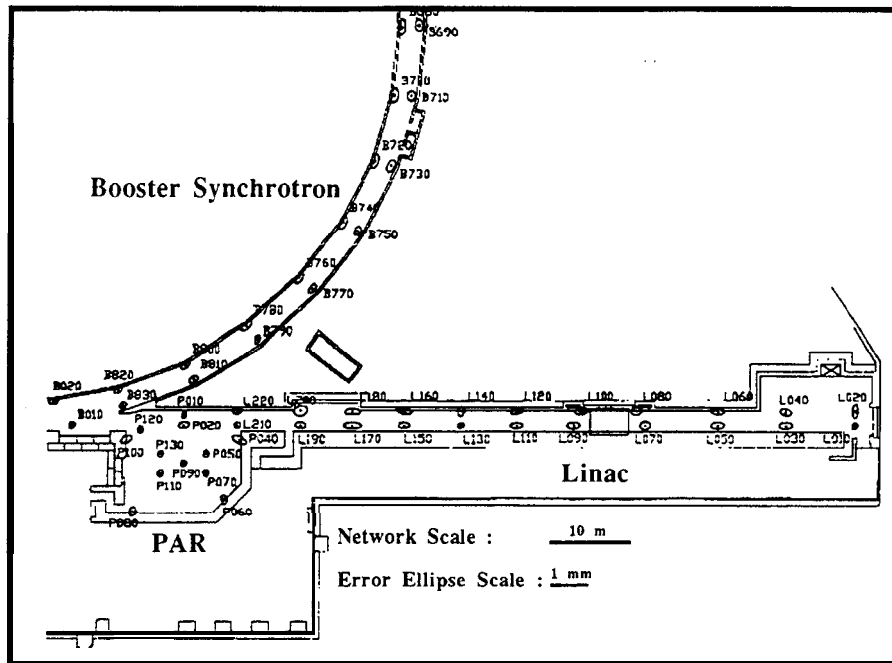

Fig. 9 Linac control network

REFERENCES

- [1] 7-GeV Advanced Photon Source Conceptual Design Report, Argonne National Laboratory, ANL-87-15, 1987.
- [2] W. Torge, Geodäsie, Sammlung Göschen, Verlag de Gruyter, 1975.
- [3] W. Großmann, Geodätische Rechnungen und Abbildungen in der Landesvermessung, Verlag Konrad Wittwer, Stuttgart, 1964.
- [4] H. Friedsam, W. Oren, *The Application of the Principal Curve Analysis Technique to Smooth Beam Lines*, SLAC, 1991.
- [5] Trevor Hastie, *Principal Curves and Surfaces*, SLAC Report-276, 1984.
- [6] D. Martin, ESRF, unpublished information, 1993.
- [7] H. Friedsam, J. Penicka, S. Zhao, *Survey and Alignment Report on the Primary Control Network for the APS*, Light Source Note LS-220, 1993.
- [8] H. Friedsam, *Proceedings of the Survey and Alignment Workshop on Data Processing using GEONET for Accelerator Alignment*, SLAC, 1992.