

UpRight

Operator Manual

MX15/19

SERIAL NO. 1600-Current

ML 010

WARNING

All personnel shall carefully read, understand and follow all safety rules, operating instructions and the Scaffold Industry Association's **MANUAL OF RESPONSIBILITIES** before performing maintenance on or operating any UpRight aerial work platform.

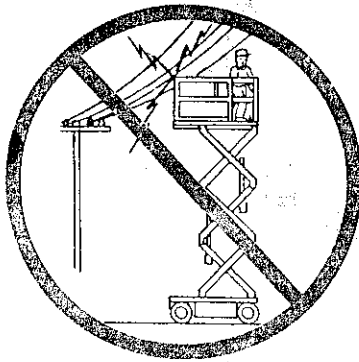

NEVER operate the machine within ten feet of power lines. **THIS MACHINE IS NOT INSULATED.**

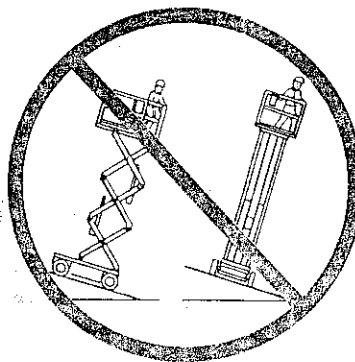

NEVER elevate the platform or drive the machine while elevated unless the machine is on firm level surface.

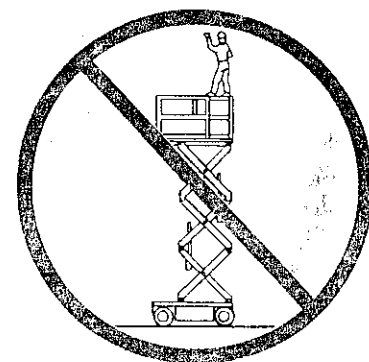

NEVER sit, stand or climb on guardrail or midrail.

NEVER operate the machine without first surveying the work area for surface hazards such as holes, drop-offs, bumps and debris before operating machine.

NEVER operate the machine if all guardrails are not properly in place and secured with all fasteners properly torqued.

SECURE chain across entrance after mounting platform.

NEVER use ladders or scaffolding on the platform.

NEVER attach overhanging loads or increase platform size.

LOOK up, down and around for overhead obstructions and electrical conductors.

DISTRIBUTE all loads evenly on the platform. See the back cover for maximum platform loads.

NEVER use damaged equipment. (Contact UpRight for instructions. See toll free number on back cover.)

NEVER change operating or safety systems.

INSPECT the machine thoroughly for cracked welds, loose hardware, hydraulic leaks, damaged control cable, loose wire connections and wheel bolts.

NEVER climb down elevating assembly with the platform elevated.

NEVER perform service on machine while platform is elevated without blocking elevating assembly.

NEVER recharge batteries near sparks or open flame; batteries that are being charged emit highly explosive hydrogen gas.

AFTER USE secure the work platform against unauthorized use by turning key switch off and removing key.

NEVER replace any component or part with anything other than original UpRight replacement parts without the manufacturers written consent.

Safety Rules and Operating Instructions

Safety Rules and Operating Instructions

Introduction

This manual covers the MX15/19 Work Platforms. **This manual must be stored on the machine at all times.**

Pre-Operation and Safety Inspection

Read, understand and follow all safety rules and operating instructions and then perform the following steps each day before use.

1. Open modules and inspect for damage, oil leaks or missing parts.
2. Check the level of the hydraulic oil with the platform fully lowered. The hydraulic reservoir is located at the rear of the machine. Remove the reservoir cap, oil should be visible on the dipstick. Add ISO #46 hydraulic oil if necessary.
3. Check that fluid level in the batteries is correct (See Battery Maintenance, Page 6).
4. Verify batteries are charged.
5. Check that A.C. extension cord has been disconnected from the plug in the right Chassis Module (Figure 4) and the module door secured.
6. Check that all guardrails are in place and all fasteners are properly tightened.
7. Carefully inspect the entire work platform for damage such as cracked welds or structural members, loose or missing parts, oil leaks, damaged cables or hoses, loose connections and tire damage.
8. Move machine, if necessary, to unobstructed area to allow for full elevation.
9. Turn Chassis and Platform Emergency Stop Switches ON (Figure 1 & 2) by pulling the button out.
10. Turn the Chassis Key Switch (Figure 1) to **CHASSIS**.
11. Push Chassis Lift Switch (Figure 1) to **UP** position and fully elevate platform.

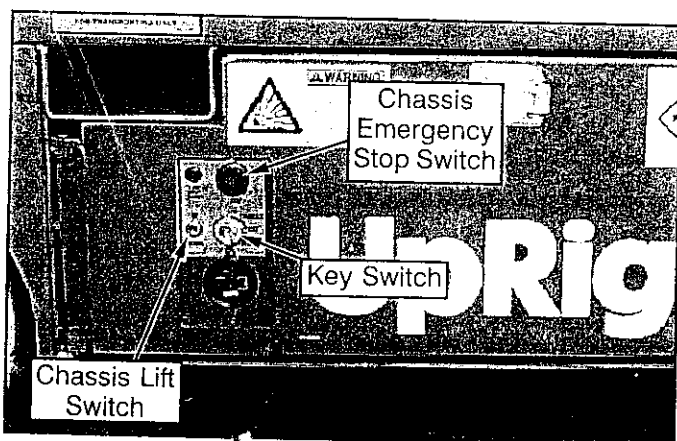

Figure 1: Chassis, Right Side

12. Visually inspect the elevating assembly for damage or erratic operation. Check for missing or loose parts.
13. Partially lower the platform by pushing Chassis Lift Switch to **DOWN**, and check operation of the audible lowering alarm.
14. Open the Chassis Emergency Lowering Valve (Figure 3) to check for proper operation, by pulling the knob out. When the platform is lowered, release the knob.
15. Turn the Chassis Key Switch to **DECK**.
16. Close and latch module doors.
17. Check that route is clear of persons, obstructions, holes and drop-offs, level and capable of supporting the wheel loads.
18. After mounting platform latch chain across entrance.
19. Pull Emergency Stop Button out to the ON position.
20. Position Power Switch to **ON**.
21. Position Drive/Lift Switch to **DRIVE**.
22. While depressing the Interlock Lever, slowly position the Control Lever to **FORWARD** then **REVERSE** to check for speed and directional control. The farther you push or pull the Control Lever from center the faster the machine will travel.
23. Push Steering Switch **RIGHT** then **LEFT** to check for steering control.
24. Push the Emergency Stop Switch Button.

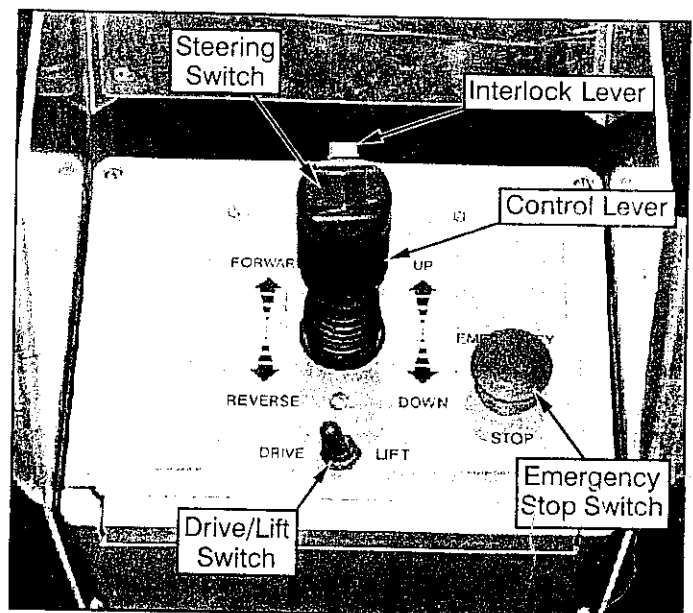

Figure 2: Controller

Operation

Before operating work platform ensure that pre-operation and safety inspection has been completed, any deficiencies have been corrected and the operator has been thoroughly trained on this machine.

Travel With Platform Lowered

1. Check that route is clear of people, obstructions, holes and drop-offs, is level and is capable of supporting wheel loads.
2. Verify Chassis Key Switch is turned to **DECK** and Chassis Emergency Stop Switch is ON, pull button out.
3. After mounting platform latch chain across entrance.
4. Check clearances above, below and to the sides of platform.
5. Pull Controller Emergency Stop Button out to ON position. When button is pushed down Emergency Stop Switch will automatically go to OFF position.
6. Position Power Switch to **ON**.
7. Position Drive/Lift Switch to **DRIVE**.
8. While depressing the Interlock Lever, slowly push or pull the Control Lever to **FORWARD** or **REVERSE** position to travel in the desired direction. The farther you push or pull the Control Lever from center the faster the machine will travel.

Steering

1. With Power Switch **ON**, position Drive/Lift Switch to **DRIVE**.
2. While depressing the Interlock Lever, push the Steering Switch to **RIGHT** or **LEFT** to turn wheels in the desired direction. Observe the tires while maneuvering the work platform to ensure proper direction.

NOTE: Steering is not self-centering. Wheels must be returned to straight ahead position by operating Steering Switch.

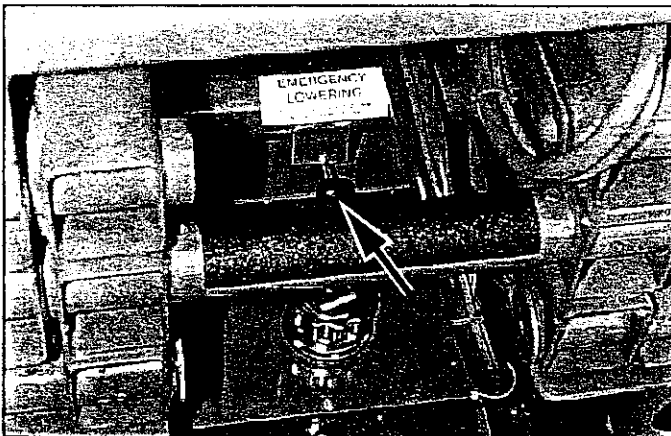

Figure 3: Emergency Lowering Valve Knob

Elevating Platform

1. With Power Switch **ON**, position Drive/Lift Switch to **LIFT**.
2. While depressing the Interlock Lever, push Control Lever forward to **UP**, the farther you push the Control Lever the faster the Platform will elevate.
3. If the machine is not level the Tilt Alarm will sound and the machine will not lift or drive. **If the Tilt alarm sounds the platform must be lowered and the machine moved to a level location before attempting to re-elevate the Platform.**

Travel With Platform Elevated

NOTE: Work platform will travel at reduced speed when platform is elevated.

1. Check that route is clear of persons, obstructions, holes and drop-offs, is level and capable of supporting the wheel loads.
2. Check clearances above, below and to the sides of platform.
3. With Power Switch **ON**, position Drive/Lift Switch to **DRIVE** position.
4. While depressing the Interlock Lever, push Control Lever to **FORWARD** or **REVERSE** for desired direction of travel.
5. If the machine is not level the Tilt Alarm will sound and the machine will not lift or drive. **If the Tilt alarm sounds the platform must be lowered and the machine moved to a level location before attempting to re-elevate the Platform.**

Lowering Platform

1. Position Drive/Lift Switch to **LIFT**.
2. While depressing the Interlock Lever, pull back on the Control Lever.

Emergency Lowering



WARNING



If the platform should fail to lower, **NEVER** climb down the elevating assembly.

The Emergency Lowering Valve Knob is located between the scissors at the rear of the machine (Figure 3).

1. Open the Emergency Lowering Valve by pulling and holding the knob.
2. To close, release the knob.

The platform will not elevate if the Emergency Lowering Valve is open.

After Use Each Day

1. Ensure that the platform is fully lowered.
2. Park the machine on level ground, preferably under cover, secure against vandals, children or unauthorized operation.
3. Turn the Key Switch to **OFF** and remove the key to prevent unauthorized operation.

Parking Brake Release (Figure 4)

Perform the following only when the machine will not operate under its own power and it is necessary to move the machine or when towing the machine up a grade or winching onto a trailer to transport.

The Brake Adjustment/Release Bolt is located at the rear of the machine between the rear wheels.

1. To release the brakes loosen the jam nut and bolt until the brakes disengage from the tires.
2. The machine will now roll when pushed or pulled.
3. To re-engage the brakes tighten the bolt until the brakes have fully engaged the tires, secure the bolt with the locknut. Be sure to verify that the brakes have fully engaged the rear tires before the machine is operated.

▲ WARNING ▲
Never operate work platform with the Parking Brakes released. Serious injury or damage could result.
Never tow faster than 1 ft./sec. (.3m/sec.).

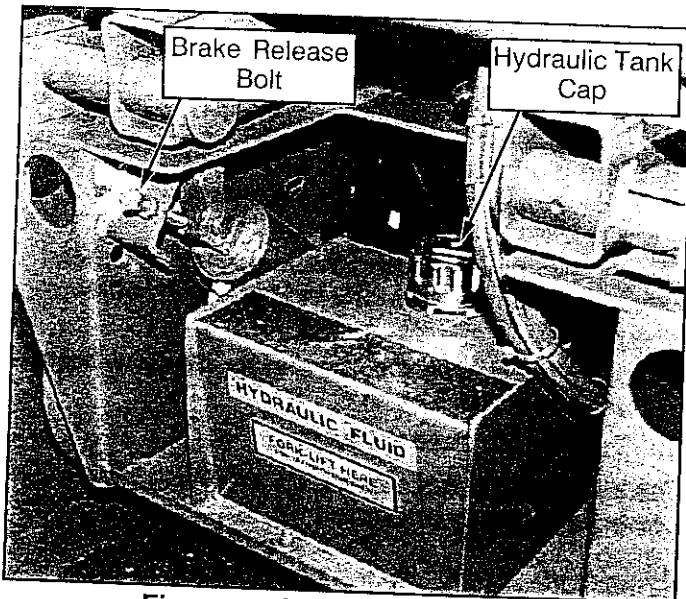

Figure 4: Chassis Rear View

Transporting Work Platform

By Forklift

NOTE: Forklifting is for transporting only.

▲ CAUTION ▲
See specifications for weight of work platform and be certain that forklift is of adequate capacity to lift platform.

Forklift from side or rear using fork pockets provided (Figure 5).

By Crane

1. Secure straps to chassis lifting/tie down points only (Figure 5).

By Truck

1. Maneuver the work platform into transport position and chock wheels.
2. Secure the work platform to the transport vehicle with chains or straps of adequate load capacity attached to the chassis lifting/tie down points (Figure 5).

▲ CAUTION ▲
Overtightening of chains or straps attached to tie down lugs may result in damage to work platform.

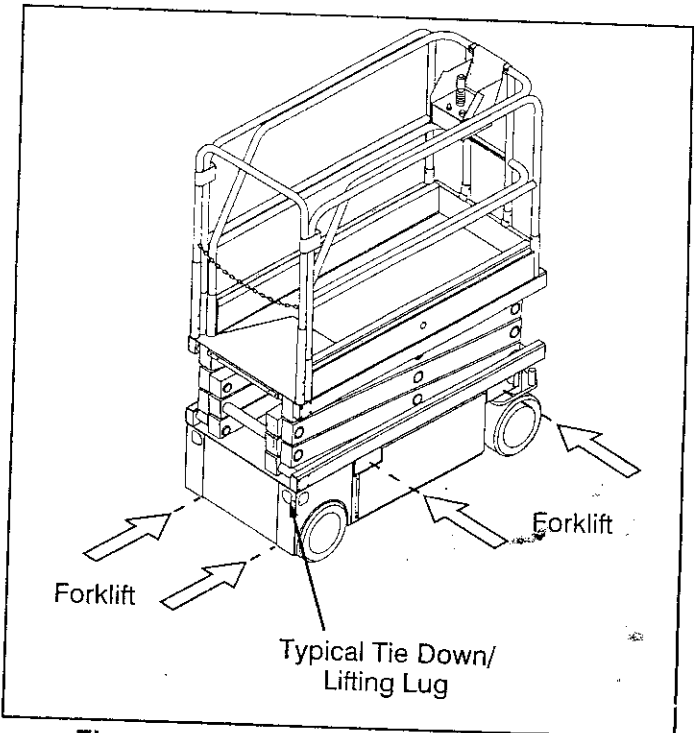

Figure 5: Transporting Work Platform

Maintenance



DANGER



Never perform service on the work platform in the Elevating Assembly area while the platform is elevated without first blocking the Elevating Assembly.

Blocking Elevating Assembly (Figure 6)

Installation

1. Park the work platform on firm level ground.
2. Verify Platform Emergency Stop Switch is ON.
3. Turn Chassis Key Switch to **CHASSIS**.
4. Position Chassis Lift Switch to **UP** and elevate platform approximately 7 Ft. (2.1 m).
5. Rotate Scissor Brace to a vertical position.
6. Lower Platform until end of Scissor Arm Weldment rests on Brace.

Storage

1. Slowly raise Platform from the Chassis Controls, while holding Brace, until the end of the Scissor Arm Weldment clears the Scissor Brace.
2. Rotate Scissor Brace forward to rest on Chassis.

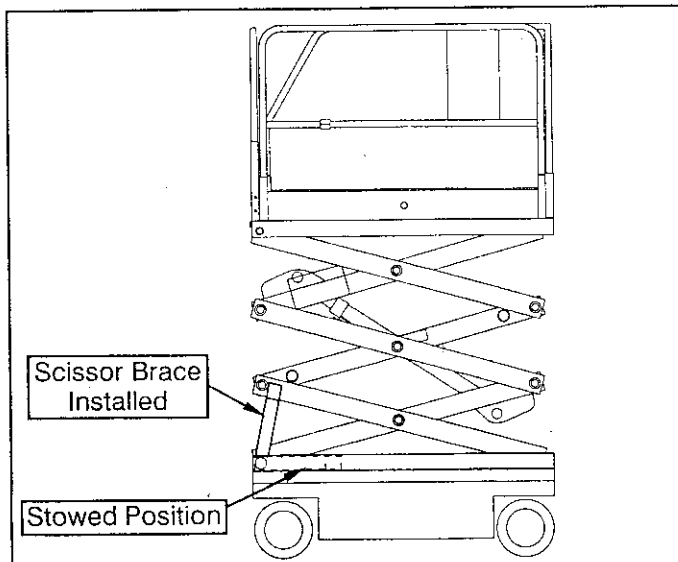

Figure 6: Blocking Elevating Assembly

Routine Service

Use the following table as a guide for routine maintenance, refer to the Service Manual for complete service instructions.

SERVICE OPERATION	INTERVAL			
	Daily	Monthly or 50 Hrs.	6 Months or 250 Hrs.	2 Years or 1000 Hrs.
Clean entire work platform	X			
Check battery fluid level	X			
Charge batteries	X			
Check tires for damage	X			
Check hydraulic fluid level	X			
Check for peeling, faded or missing labels & replace	X			
Check deck and guardrail fasteners for proper torque	X			
Inspect elevating assembly for bends or cracks	X			
Check for & repair collision damage	X			
Check emergency lowering valve operation	X			
Check electric motor brushes		X		
Check pivot pin retaining rings	X			
Change hydraulic filter			X	
Check all fasteners for proper torque			X	
Change hydraulic fluid				X

Battery Maintenance

⚠ WARNING ⚠
Hazard of explosive gas mixture. Keep sparks, flame and smoking materials away from batteries.
Always wear safety glasses when working with batteries.
Battery fluid is highly corrosive. Rinse away any spilled fluid thoroughly with clean water.
Always replace batteries with UpRight batteries or manufacturer approved replacements weighing at least 62 lbs. (28 kg) each.

Check battery fluid level daily, especially if work platform is being used in a warm, dry climate.

If electrolyte level is lower than $\frac{3}{8}$ in. (10 mm) above plates add distilled water **only**. DO NOT use tap water with high mineral content it will shorten battery life.

Keep terminals and tops of batteries clean.

Refer to the Service Manual to extend battery life and for complete service instructions.

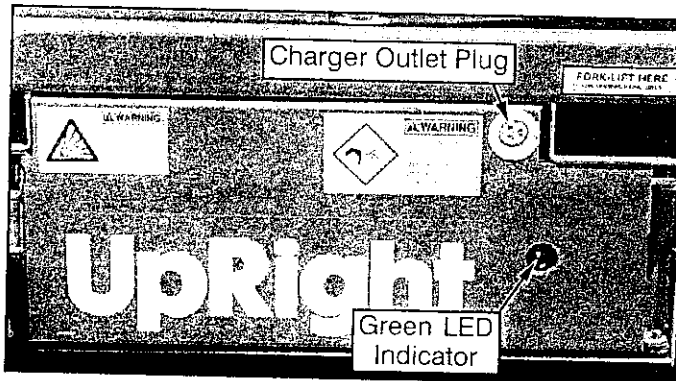

Figure 7: Chassis Module, Left Side

Battery Charging

Charge batteries at end of each work shift or sooner if batteries have been discharged.

⚠ WARNING ⚠
Charge batteries in a well ventilated area.
Do not charge batteries when the work platform is in an area containing sparks or flames.
Permanent damage to batteries will result if batteries are not immediately recharged after discharging.
Never leave charger operating unattended for more than two days.
Never disconnect cables from batteries when charger is operating.
Keep charger dry.

1. Check battery fluid level. If electrolyte level is lower than $\frac{3}{8}$ in. (10 mm) above plates add distilled water **only**.
2. Connect extension cord to charger outlet plug in Left Chassis Door. Connect extension cord (12 gauge conductor minimum and 50 ft. (15 m) in length maximum) to properly grounded outlet of proper voltage and frequency.
3. Charger turns on automatically after a short delay, the LED charge indicator will illuminate.
4. Charger turns off automatically when batteries are fully charged, the LED charge indicator will blink.

Specifications*

ITEM	MX15	MX19
Platform Size (Inside min.) Standard w/Deck Optional w/o Deck	22.5 in. x 98.5 in. (.57 m x 2.5 m) 26 in. x 62 in. (.66 m x 1.57 m)	22.5 in. x 98.5 in. (.57 m x 2.5 m) 26 in. x 62 in. (.66 m x 1.57 m)
Maximum Platform Capacity (Distributed) Standard w/Deck Optional w/o Deck	550 lbs. (250 kg) 660 lbs. (300 kg)	500 lbs. (225 kg) 550 lbs. (250 kg)
Maximum Number of Occupants Standard w/Deck Optional w/o Deck	Two people, only one person on Deck Two people	Two people, only one person on Deck Two people
Height Working Height Maximum Platform Height Minimum Platform Height	20 ft. 9 in. (6.32 m) 14 ft. 9 in. (4.5 m) 36.2 in. (920 mm)	25 ft. (7.62 m) 19 ft. (5.8 m) 40.15 in. (1020 mm)
Dimensions Weight Overall Width Overall Height (Lowered) Overall Length (Deck in)	1,962 lbs. (890 kg) 30 in. (760 mm) 76 in. (1.93 m) 63 in. (1.60 m)	2,160 lbs. (980 kg) 30 in. (760 mm) 80 in. (2.03 m) 63 in. (1.60 m)
Driveable Height	14 ft. 9 in. (4.5 m)	19 ft. (5.8 m)
Surface Speed Platform Lowered Platform Raised	2.75 mph (4.43 km/h) .75 mph (1.2 km/h)	2.75 mph (4.43 km/h) .75 mph (1.2 km/h)
Energy Source	24V battery pack (4-220 ampere hour, 6 Volt batteries, min. wt. 62 lbs (28.12 kg) each), 4 HP DC electric motor	24V battery pack (4-220 ampere hour, 6 Volt batteries, min. wt. 62 lbs (28.12 kg) each), 4 HP DC electric motor
System Voltage	24 VDC	24 VDC
Battery Charger	20 AMP, 120 VAC 60 Hz, Automatic	20 AMP, 120 VAC 60 Hz, Automatic
Battery Duty Cycle	25% for 8 Hours	25% for 8 Hours
Hydraulic Tank Capacity	3.4 gal (12.9 L)	3.4 gal (12.9 L)
Maximum Hydraulic System Pressure	2500 psi (172 Bar)	2700 psi (186 Bar)
Lift System	One Single Stage Lift Cylinder	One Single Stage Lift Cylinder
Drive Control	Proportional	Proportional
Control System	Proportional Joystick Controller with Interlock Lever, Toggle Selector Switch, and Red Mushroom Emergency Stop Switch	Proportional Joystick Controller with Interlock Lever, Toggle Selector Switch, and Red Mushroom Emergency Stop Switch
Horizontal Drive	Dual Front Wheel	Dual Front Wheel
Tires	12 in. (30.5 cm) diameter solid rubber, Non-marking	12 in. (30.5 cm) diameter solid rubber, Non-marking
Parking Brakes	Dual, Spring Applied, Hydraulic Release	Dual, Spring Applied, Hydraulic Release
Turning Radius	1 in. (25 mm) Inside	1 in. (25 mm) Inside
Maximum Gradeability	25% (14°)	25% (14°)
Wheel Base	48.5 in. (1.23 m)	48.5 in. (1.23 m)
Guardrails	39 in. (1.02 m) or 43.5 in. (1.10 m)	39 in. (1.02 m) or 43.5 in. (1.10 m)
Toeboard	6 in. (152 mm)	6 in. (152 mm)

* Specifications subject to change without notice.

Meets or exceeds all applicable requirements of OSHA and ANSI A92.6-1990
Refer to Service Manual for complete parts and service information.

FOR MORE INFORMATION

UpRight
USA

TEL: (800) 926-5438 or (209) 896-5150
FAX: (209) 896-9012
1775 Park St., Selma, CA 93662

EUROPE

TEL: (353) 1-285-3333
FAX: (353) 1-284-0015
Pottery Road, Dun Laoire, Ireland

Local Distributor:

Safety Rules and Operating Instructions

Safety Rules and Operating Instructions

MX-SERIES LABEL INSTALLATION: THESE LABELS SHALL BE PRESENT AND IN GOOD CONDITION BEFORE OPERATING THE WORK PLATFORM. BE SURE TO READ, UNDERSTAND AND FOLLOW THESE LABELS BEFORE OPERATING THE WORK PLATFORM.

**NOTE: Labels can be ordered by using Part Number located by each label.
For machines equipped with options consult service manual.**

WARNING
MAXIMUM DISTRIBUTED PLATFORM LOAD 660 LBS. OR 2 PEOPLE.

66557-003-00
2-REQUIRED
USED ON MX-15 WITHOUT DECK

WARNING
MAXIMUM DISTRIBUTED PLATFORM LOAD 500 LBS. OR 2 PEOPLE.

66557-001-00
2-REQUIRED
USED ON MX-19 WITH DECK

WARNING
MAXIMUM DISTRIBUTED PLATFORM LOAD 550 LBS. OR 2 PEOPLE.

66557-002-00
2-REQUIRED
USED ON MX-15 WITH DECK AND MX-19 WITHOUT DECK

66554-000-00
1-REQUIRED

CAUTION
BEFORE operating this equipment read and then follow all safety information in instruction manual.

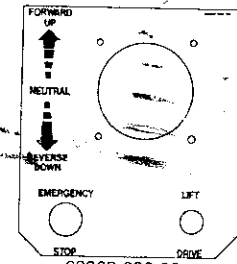

63369-000-00
1-REQUIRED

DANGER
TIP-OVER HAZARD
NO MORE THAN 1 PERSON (250 LBS.) ON EXTENDED DECK

66551-000-00
1-REQUIRED

DANGER
Failure to read, understand, and obey the following safety rules will cause death or serious injury.

TIP-OVER HAZARDS DO NOT operate on uneven or sloped or soft ground. DO NOT drive into holes of any depth or size. DO NOT use one person or 250 lbs. or more per person.	ELECTROCUTION HAZARDS DO NOT operate near live electrical wires. DO NOT use this equipment near overhead power lines. Lock up, down, and extend the platform before work.	FALL HAZARDS DO NOT operate on uneven ground. Work only on level and firm surfaces. Lower the rail and secure gate or lock before working. DO NOT use tool cut or use falling by utility. DO NOT climb down before.

66550-000-00
1-REQUIRED

10076-001-00
1-REQUIRED

ATTENTION
Safety Rules & Operating Instructions Enclosed

CAUTION
Collision Hazard
Impact from descending platform may cause injury.

66556-000-00
1-REQUIRED

BATTERY
MAINTAIN BATTERY FLUID AT RECOMMENDED LEVEL.

05221-000-00
2-REQUIRED

WARNING
Explosive gas is generated when charging batteries. DO NOT expose to sparks or flames.

66552-000-00
2-REQUIRED

MEETS OR EXCEEDS THE REQUIREMENTS OF ANSI A92.6-1979

61220-001-00
1-REQUIRED

61205-000-00
1-REQUIRED

UpRight, Inc.
MODEL NO. _____ MAX PLATFORM HEIGHT _____
SERIAL NO. _____ BATTERY VOLTAGE _____
MAX. DISTRIBUTED LOAD _____
CAUTION: CONSULT OPERATOR'S MANUAL BEFORE USE. THIS PLATFORM IS NOT ELECTRICALLY INSULATED.

DANGER
TIP-OVER HAZARD
BATTERIES ACT AS CORROSION HAZARD. EACH REPLACE BATTERY BUNDLE WITHIN 30 SECS. OR MORE.

62562-001-00
2-REQUIRED

WARNING
KEEP CLEAR OF SCISSORS. BLOCK SCISSORS BEFORE SERVICING.

66553-000-00
2-REQUIRED

66558-000-00
1-REQUIRED

EMERGENCY LOWERING
PULL OUT TO LOWER PLATFORM. RE-ENGAGE FROM THE SIDE.

SCISSOR BRACE INSTRUCTIONS

POSITIONING	STORAGE
1. LOWER PLATFORM FROM POWER CONTROLS APPROXIMATELY 1 FT. 2. LOWER PLATFORM BACK TO A VERTICAL POSITION. 3. LOWER PLATFORM BACK UP TO LOCKS IN AND TIGHTEN BOTH IN STAGE.	1. LOWER LOWER PLATFORM (TRIPLE HOLDING BRACE) WITH THE SIDE PIN BY SCISSOR AND WELDED CHAIN (SCISSOR BRACE). 2. NEVER SELECT DOWN STAGE FORWARD IN USE ON CHASSIS.

63255-001-00
1-REQUIRED

UP CHASSIS
DOWN DECK
EMERGENCY STOP
OFF

65788-000-00
1-REQUIRED

CAUTION
Limit switches, pressure switches, and relief valves are adjusted at the factory. Proper adjustment is required.

66555-000-00
1-REQUIRED

FORK-LIFT HERE
FOR TRANSPORTING ONLY

14222-003-99
5-REQUIRED

HYDRAULIC FLUID

60197-000-00
1-REQUIRED