

Rev	2	2023-03-01
File	Finder/Filter0_XC2V6000	
Sheet	1	1

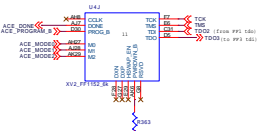

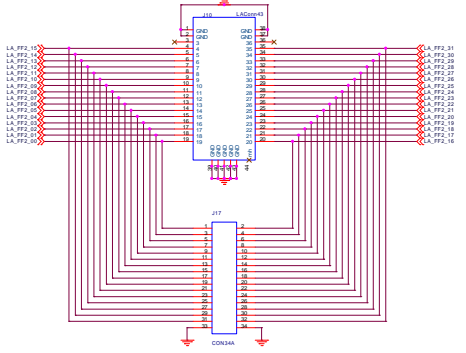

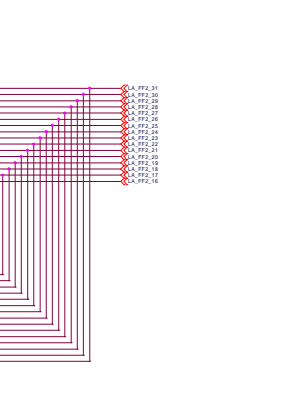
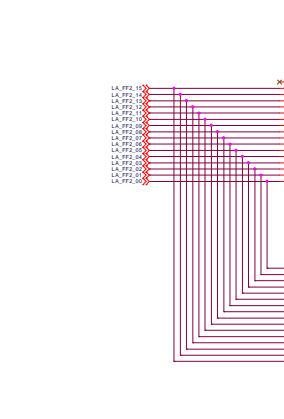
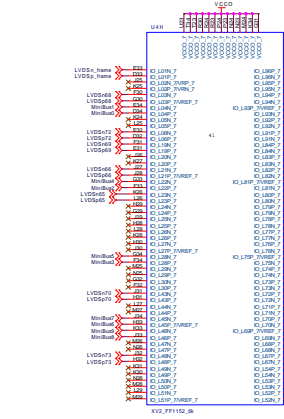
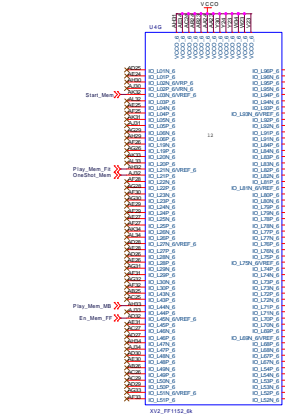
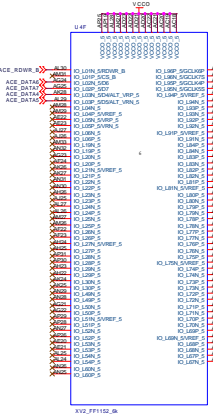
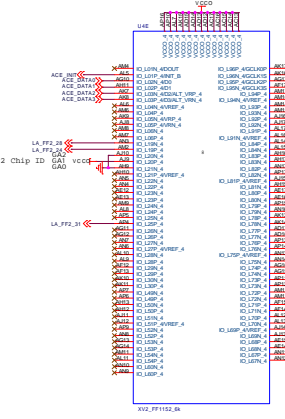
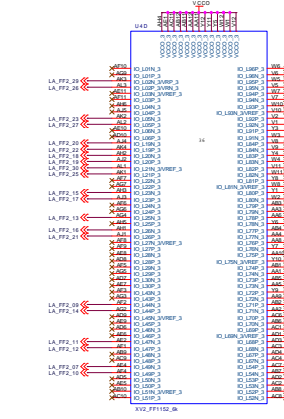
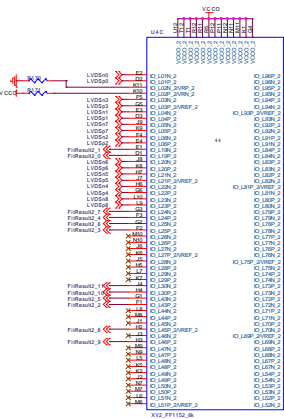
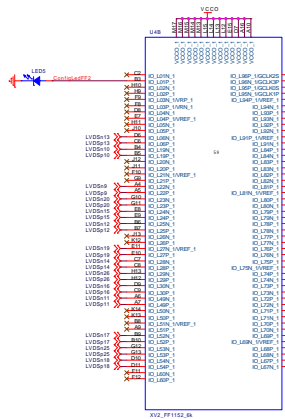
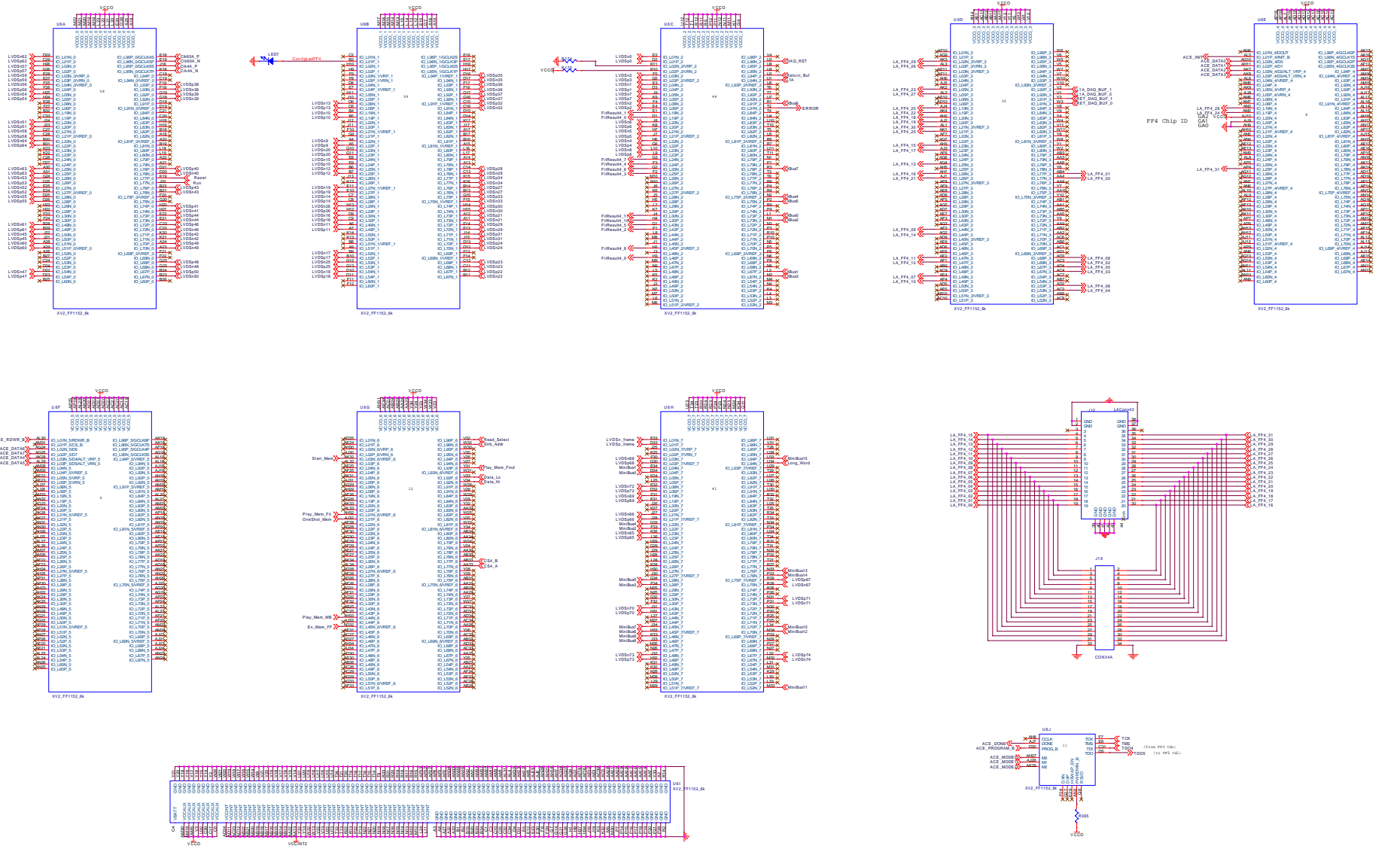
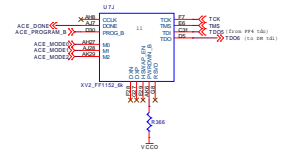
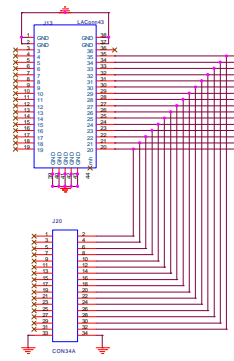
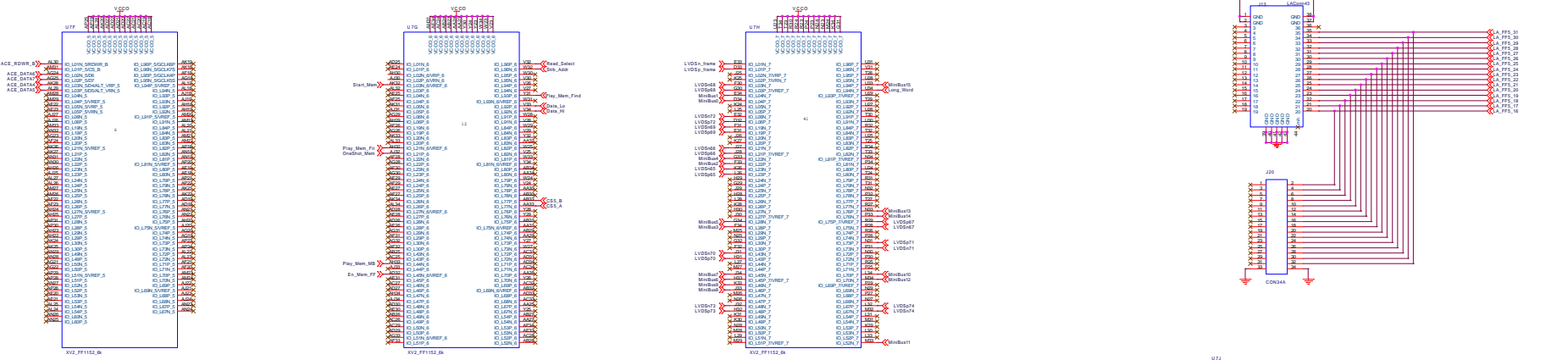
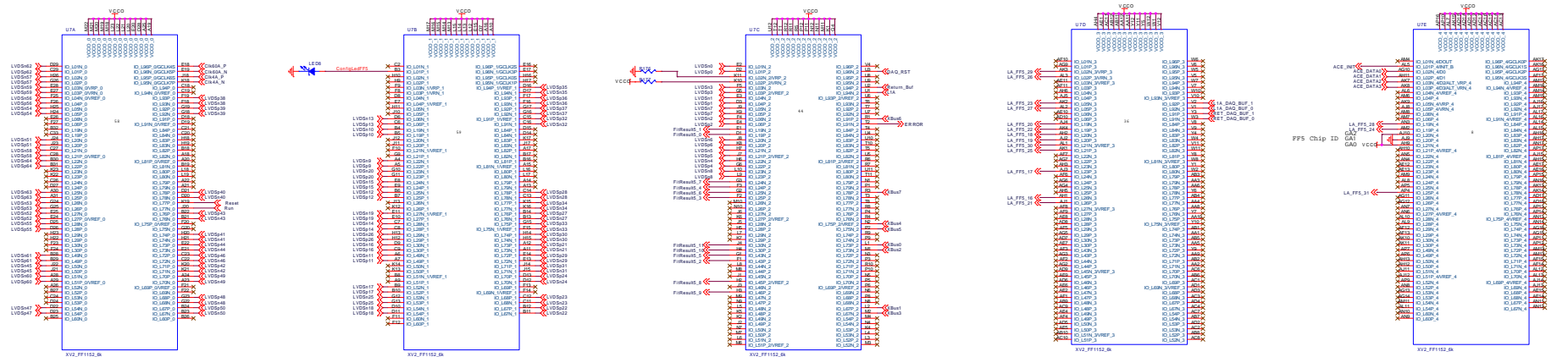

Finder/Filter5 XC2V6000	
Sheet	272 out of 272
Sheet Number	1
Sheet	1
Created	Wednesday, 20/06/2007 10:00
Item	1
Page	1

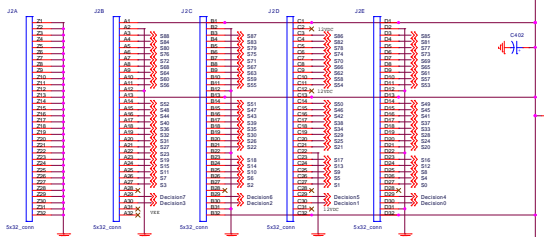
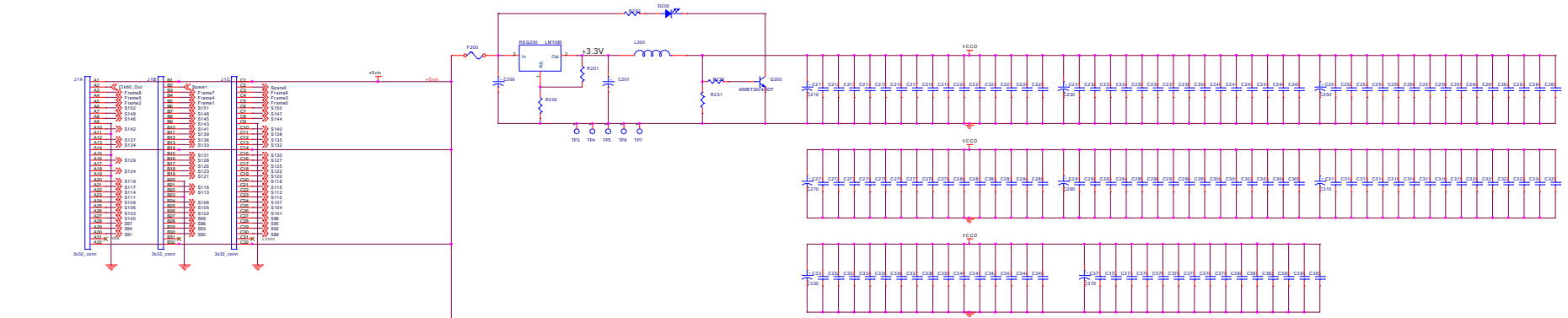

Stephen needs to check the location of sigs decision 6 and 7 on connector J2

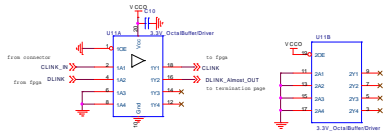
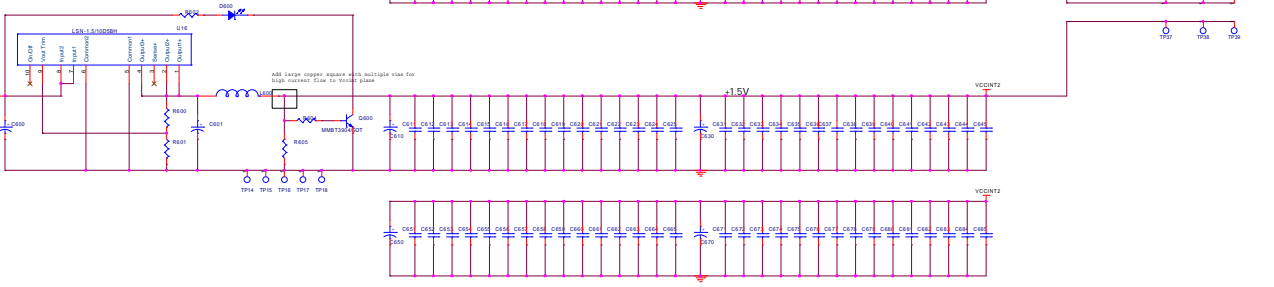
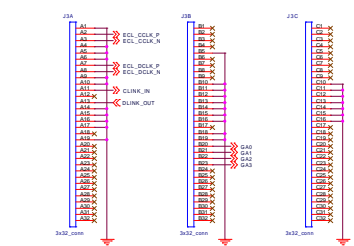
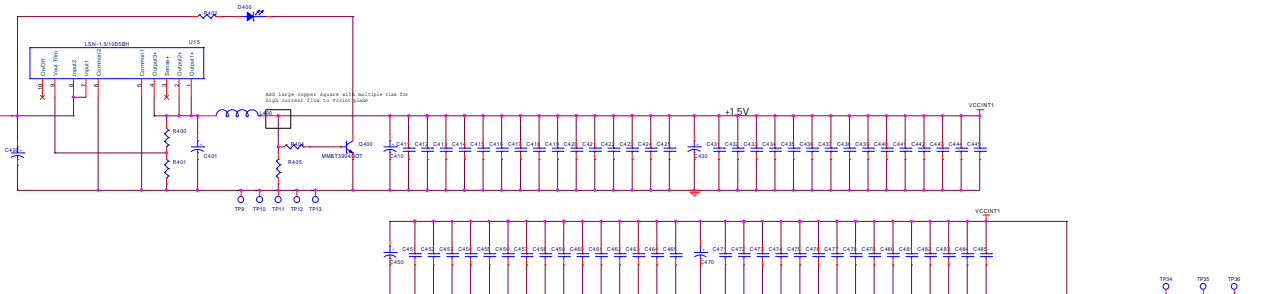

Counter Address(?) LEDs (32)

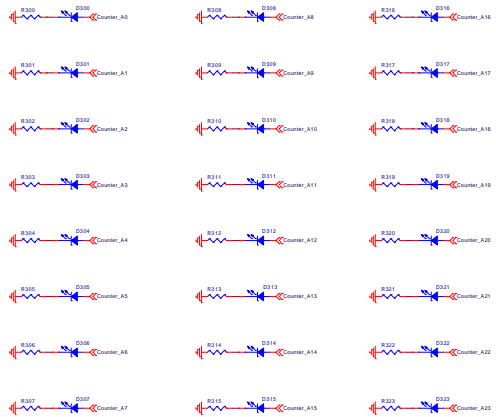

Diagnostic Memory LEDs (13)

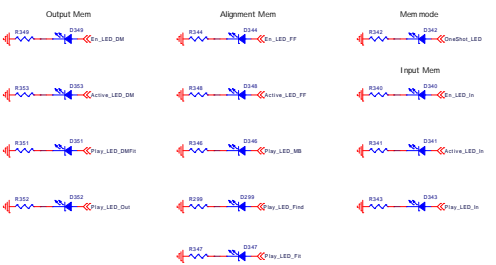

Software LEDs (4)

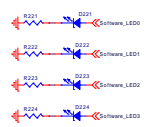

Run LED (blue)

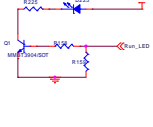

Serial Number Bits

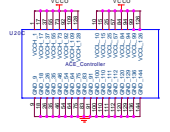
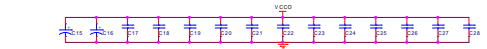
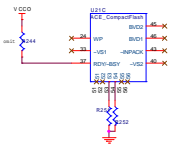
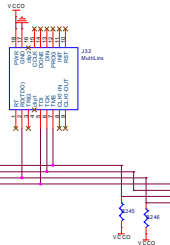
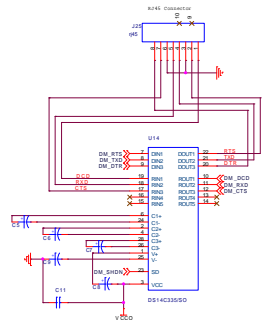
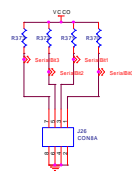

System ACE Download

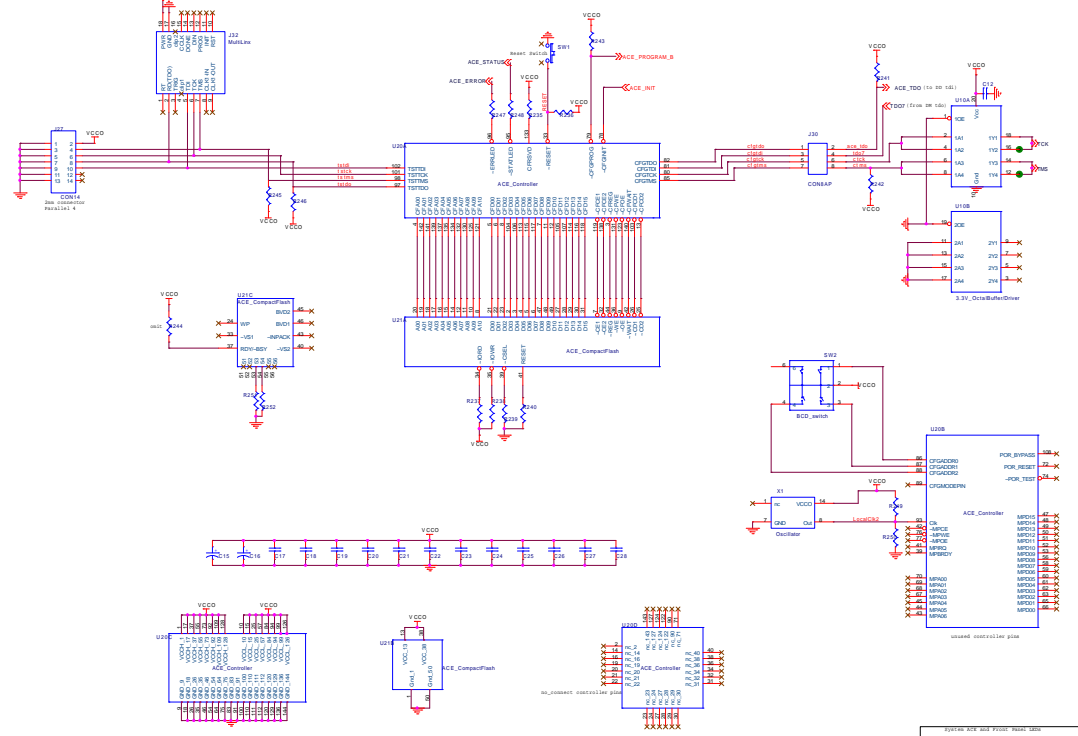

E:\HW\2008\HW_FPGA\HW_PCB1_000	
Rev	2/20
Doc Number	HW_PCB1_000
Doc	HW_PCB1_000
Created	2008-08-20 10:11:11

