

ZPDI. 1
8-7-2002_17:16

SHEET 1 OF 29

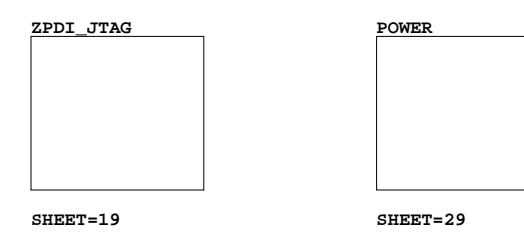

SHEET=19 SHEET=29

BABAR ZPDI AUXILIARY BD 2

STANFORD LINEAR ACCELERATOR CENTER U.S. DEPARTMENT OF ENERGY		
STANFORD UNIVERSITY	STANFORD, CALIFORNIA	
PROPRIETARY DATA OF STANFORD UNIVERSITY AND/OR U.S. DEPARTMENT OF ENERGY. RECIPIENT SHALL NOT PUBLISH THE INFORMATION WITHIN UNLESS GRANTED SPECIFIC PERMISSION OF STANFORD UNIVERSITY.		
DATE	DATE	APPROVALS
04/09/02		
NAME	Jeff Olsen	
DATE		
CHKD		

BABAR
ZPDI
AUXILIARY BOARD 2

SD-350-755-23-R01

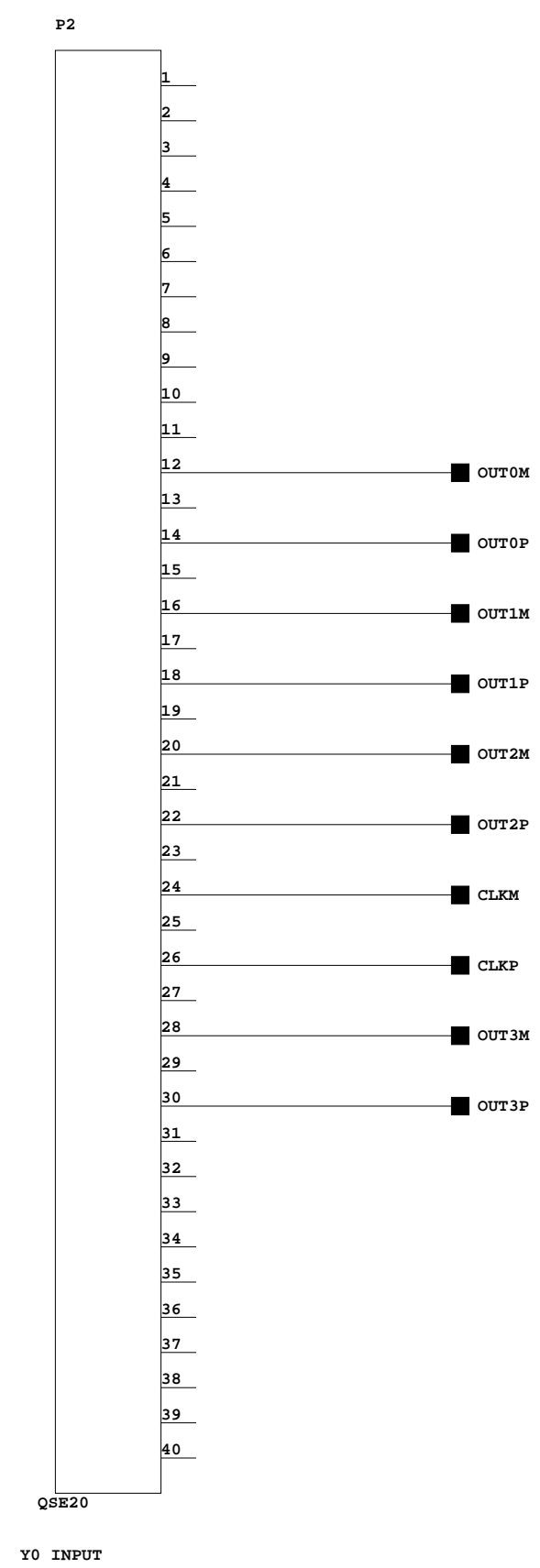

ZPDIN. 1
3-5-2003_13:34

BABAR ZPDI AUXILIARY BD 2

STANFORD LINEAR ACCELERATOR CENTER U.S. DEPARTMENT OF ENERGY		
STANFORD UNIVERSITY	STANFORD, CALIFORNIA	
<small>PROPRIETARY DATA OF STANFORD UNIVERSITY AND/OR U.S. DEPARTMENT OF ENERGY. RECIPIENT SHALL NOT PUBLISH THE INFORMATION WITHIN UNLESS GRANTED SPECIFIC PERMISSION OF STANFORD UNIVERSITY.</small>		
DATE	APPROVALS	
<small>BY</small> Jeff Olsen	<small>DATE</small> 04/09/02	
<small>CHKD</small>		

SHEET 21 OF 29 BABAR ZPDI AUXILIARY BOARD 2
SD-350-755-23-R01

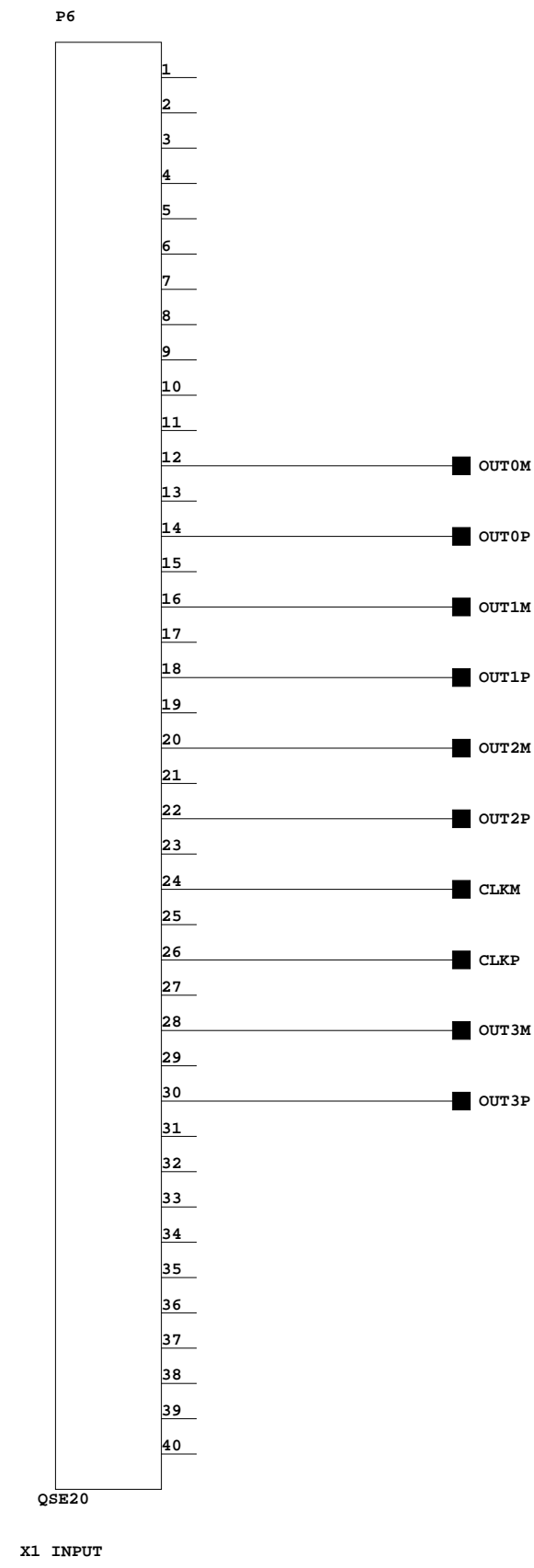

ZPDIN. 1
3-5-2003_13:34

STANFORD LINEAR ACCELERATOR CENTER U.S. DEPARTMENT OF ENERGY		
STANFORD UNIVERSITY	STANFORD, CALIFORNIA	
<small>PROPRIETARY DATA OF STANFORD UNIVERSITY AND/OR U.S. DEPARTMENT OF ENERGY. RECIPIENT SHALL NOT PUBLISH THE INFORMATION WITHIN UNLESS GRANTED SPECIFIC PERMISSION OF STANFORD UNIVERSITY.</small>		
DATE	DATE	APPROVALS
BY	04/09/02	
BY		
CHKD		

BABAR
ZPDI
AUXILIARY BOARD 2

SD-350-755-23-R01

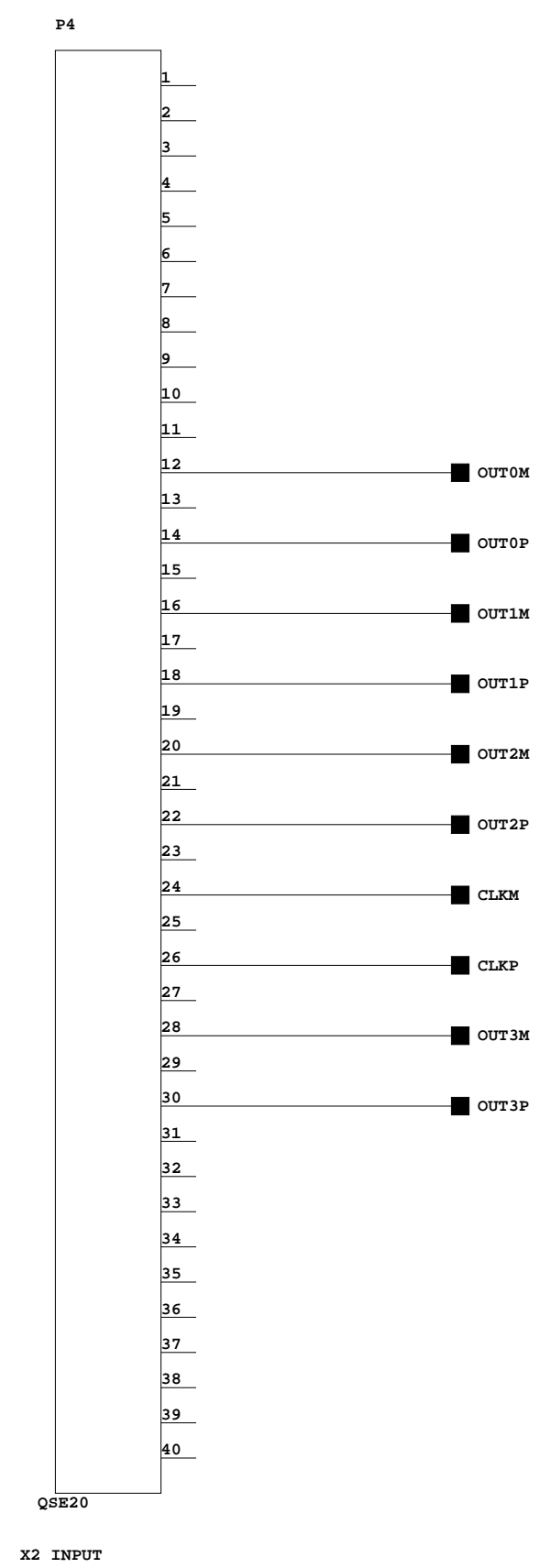

X2 INPUT

ZPDIN. 1
3-5-2003_13:34

BABAR ZPDI AUXILIARY BD 2

STANFORD LINEAR ACCELERATOR CENTER U.S. DEPARTMENT OF ENERGY		
STANFORD UNIVERSITY	STANFORD, CALIFORNIA	
<small>PROPRIETARY DATA OF STANFORD UNIVERSITY AND/OR U.S. DEPARTMENT OF ENERGY. RECIPIENT SHALL NOT PUBLISH THE INFORMATION WITHIN UNLESS GRANTED SPECIFIC PERMISSION OF STANFORD UNIVERSITY.</small>		
DATE	APPROVALS	
<small>ENGR</small> Jeff Olsen	04/09/02	
<small>DTFR</small>		
<small>CHKD</small>		

SHEET 23 OF 29 BABAR ZPDI AUXILIARY BOARD 2
SD-350-755-23-R01

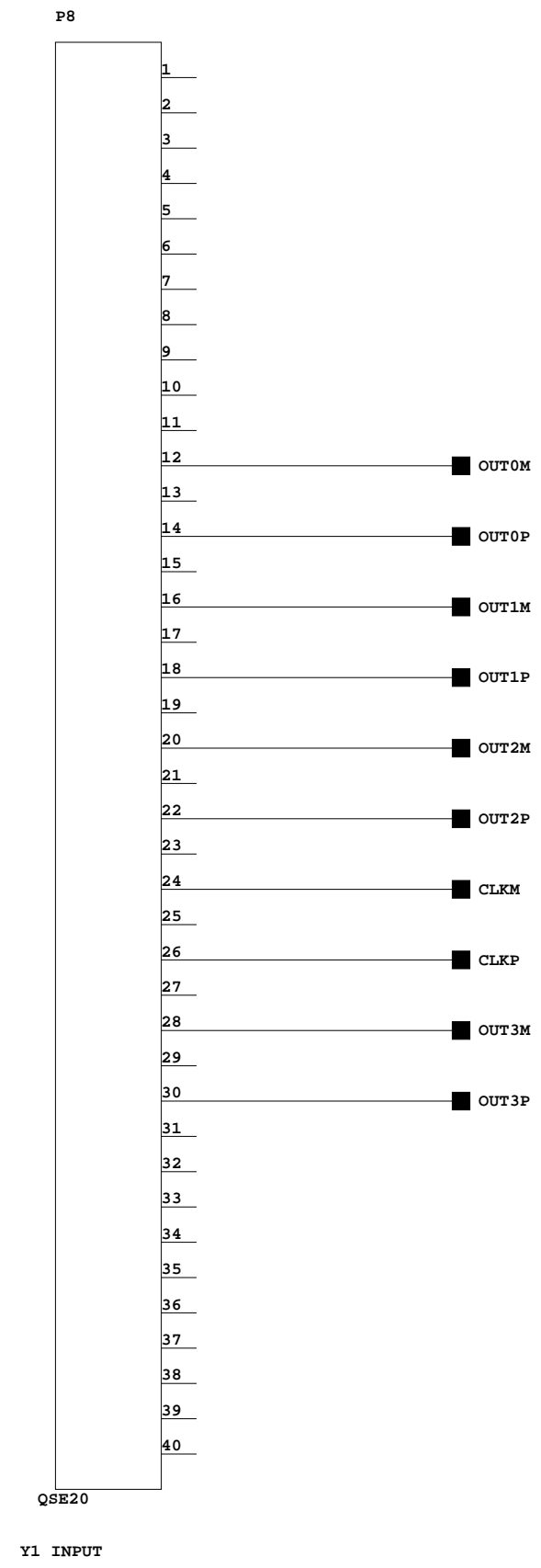

ZPDIN. 1
3-5-2003_13:34

BABAR ZPDI AUXILIARY BD 2

STANFORD LINEAR ACCELERATOR CENTER U.S. DEPARTMENT OF ENERGY		
<small>STANFORD UNIVERSITY</small>	<small>STANFORD, CALIFORNIA</small>	
<small>PROPRIETARY DATA OF STANFORD UNIVERSITY AND/OR U.S. DEPARTMENT OF ENERGY. RECIPIENT SHALL NOT PUBLISH THE INFORMATION WITHIN UNLESS GRANTED SPECIFIC PERMISSION OF STANFORD UNIVERSITY.</small>		
<small>DATE</small>	<small>APPROVALS</small>	
<small>BY</small> Jeff Olsen	<small>DATE</small> 04/09/02	
<small>CHKD</small>		
<small>APPV</small>		

SHEET 24 OF 29 BABAR ZPDI AUXILIARY BOARD 2
SD-350-755-23-R01

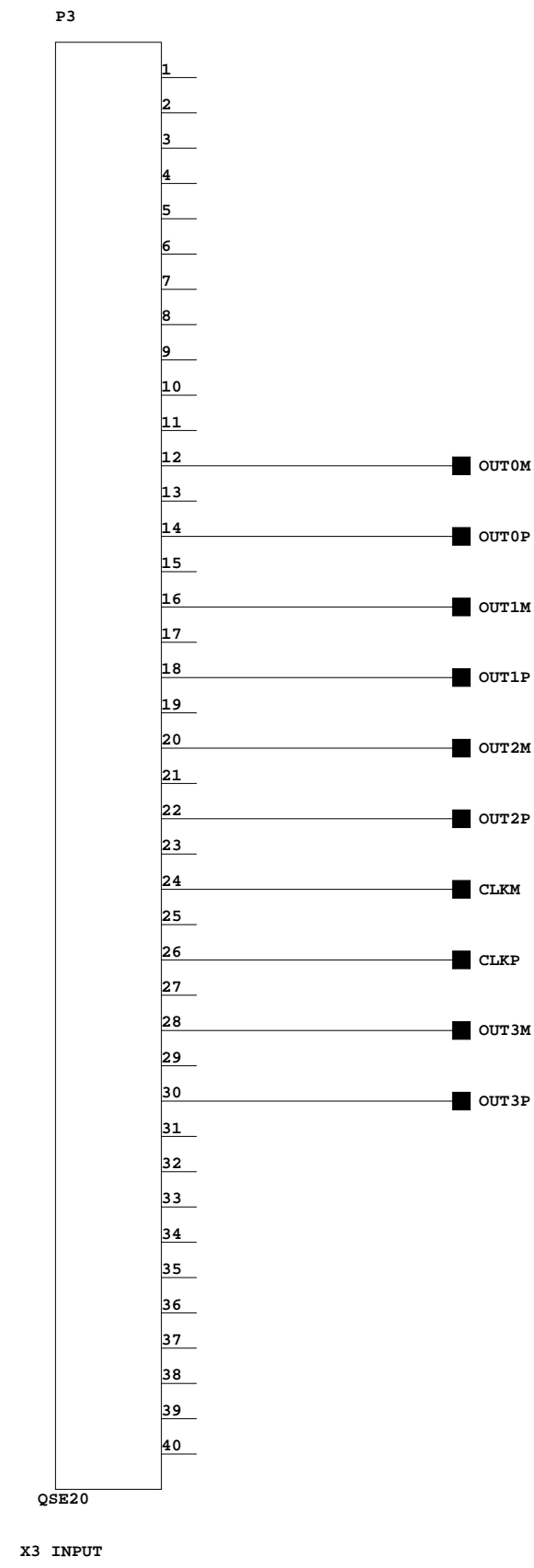

X3 INPUT

BABAR ZPDI AUXILIARY BD 2

ZPDIN. 1
3-5-2003_13:34

STANFORD LINEAR ACCELERATOR CENTER U.S. DEPARTMENT OF ENERGY		
STANFORD UNIVERSITY	STANFORD, CALIFORNIA	
<small>PROPRIETARY DATA OF STANFORD UNIVERSITY AND/OR U.S. DEPARTMENT OF ENERGY. RECIPIENT SHALL NOT PUBLISH THE INFORMATION WITHIN UNLESS GRANTED SPECIFIC PERMISSION OF STANFORD UNIVERSITY.</small>		
DATE	DATE	APPROVALS
BY	04/09/02	
BY		
CHKD		

SHEET 25 OF 29
BABAR ZPDI AUXILIARY BOARD 2
SD-350-755-23-R01

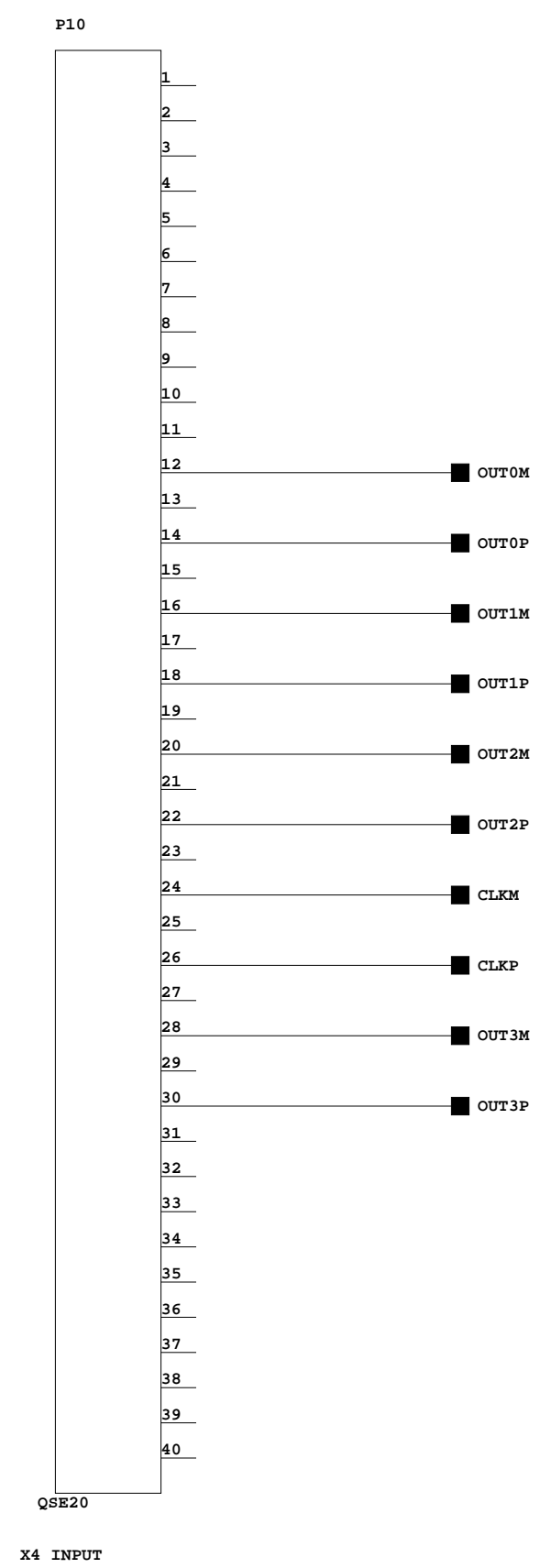

ZPDIN. 1
3-5-2003_13:34

BABAR ZPDI AUXILIARY BD 2

STANFORD LINEAR ACCELERATOR CENTER U.S. DEPARTMENT OF ENERGY		
STANFORD UNIVERSITY	STANFORD, CALIFORNIA	
<small>PROPRIETARY DATA OF STANFORD UNIVERSITY AND/OR U.S. DEPARTMENT OF ENERGY. RECIPIENT SHALL NOT PUBLISH THE INFORMATION WITHIN UNLESS GRANTED SPECIFIC PERMISSION OF STANFORD UNIVERSITY.</small>		
DATE	APPROVALS	
<small>ENGR</small> Jeff Olsen	04/09/02	
<small>DATE</small>		
<small>CHKD</small>		

SHEET 26 OF 29 BABAR ZPDI AUXILIARY BOARD 2
SD-350-755-23-R01

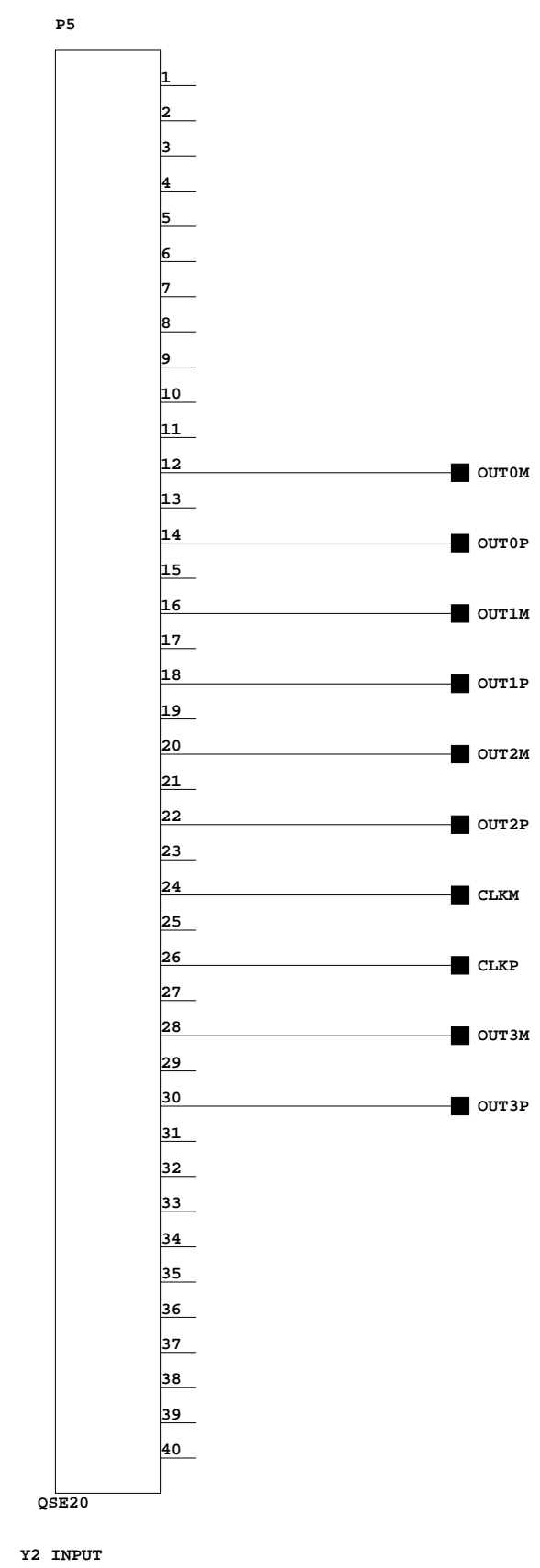

Y2 INPUT

ZPDIN. 1
3-5-2003_13:34

BABAR ZPDI AUXILIARY BD 2

STANFORD LINEAR ACCELERATOR CENTER U.S. DEPARTMENT OF ENERGY		
STANFORD UNIVERSITY	STANFORD, CALIFORNIA	
<small>PROPRIETARY DATA OF STANFORD UNIVERSITY AND/OR U.S. DEPARTMENT OF ENERGY. RECIPIENT SHALL NOT PUBLISH THE INFORMATION WITHIN UNLESS GRANTED SPECIFIC PERMISSION OF STANFORD UNIVERSITY.</small>		
DATE	APPROVALS	
<small>ENGR</small> Jeff Olsen	04/09/02	
<small>DATE</small>		
<small>CHKD</small>		

SHEET 27 OF 29 BABAR ZPDI AUXILIARY BOARD 2
SD-350-755-23-R01

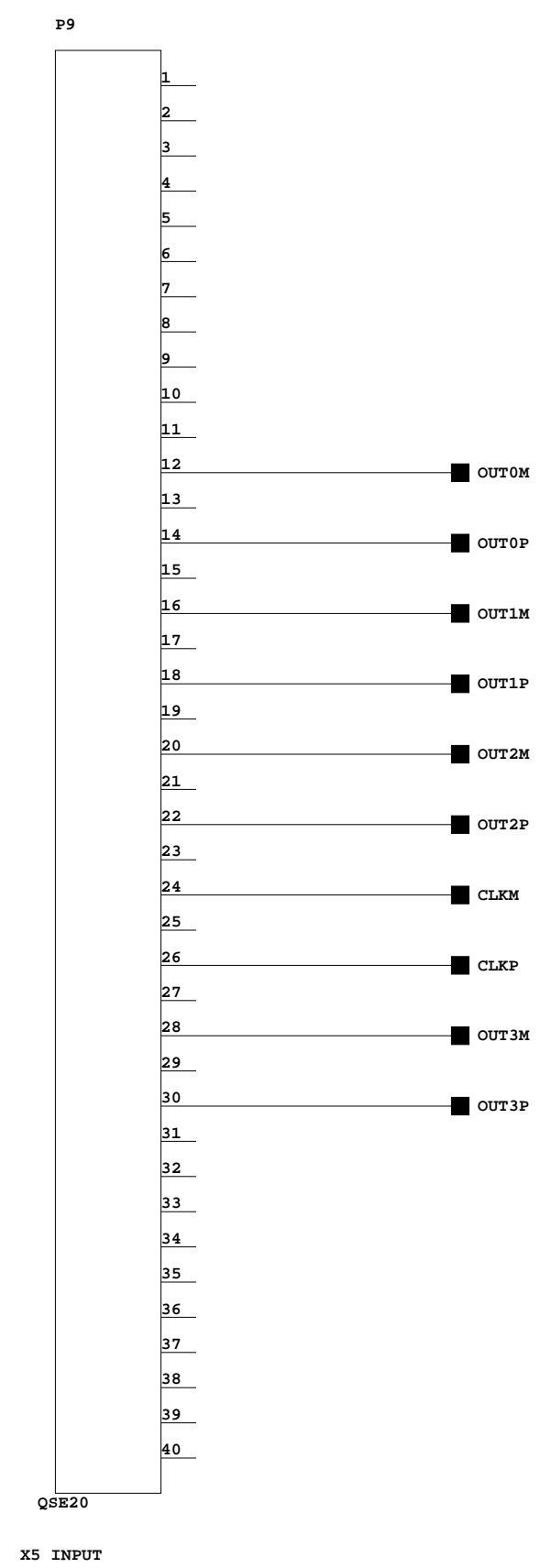

ZPDIN. 1
3-5-2003_13:34

BABAR ZPDI AUXILIARY BD 2

STANFORD LINEAR ACCELERATOR CENTER U.S. DEPARTMENT OF ENERGY		
STANFORD UNIVERSITY	STANFORD, CALIFORNIA	
<small>PROPRIETARY DATA OF STANFORD UNIVERSITY AND/OR U.S. DEPARTMENT OF ENERGY. RECIPIENT SHALL NOT PUBLISH THE INFORMATION WITHIN UNLESS GRANTED SPECIFIC PERMISSION OF STANFORD UNIVERSITY.</small>		
DATE	DATE	APPROVALS
BY	04/09/02	
BY		
CHKD		

SHEET 28 OF 29
BABAR ZPDI AUXILIARY BOARD 2
SD-350-755-23-R01

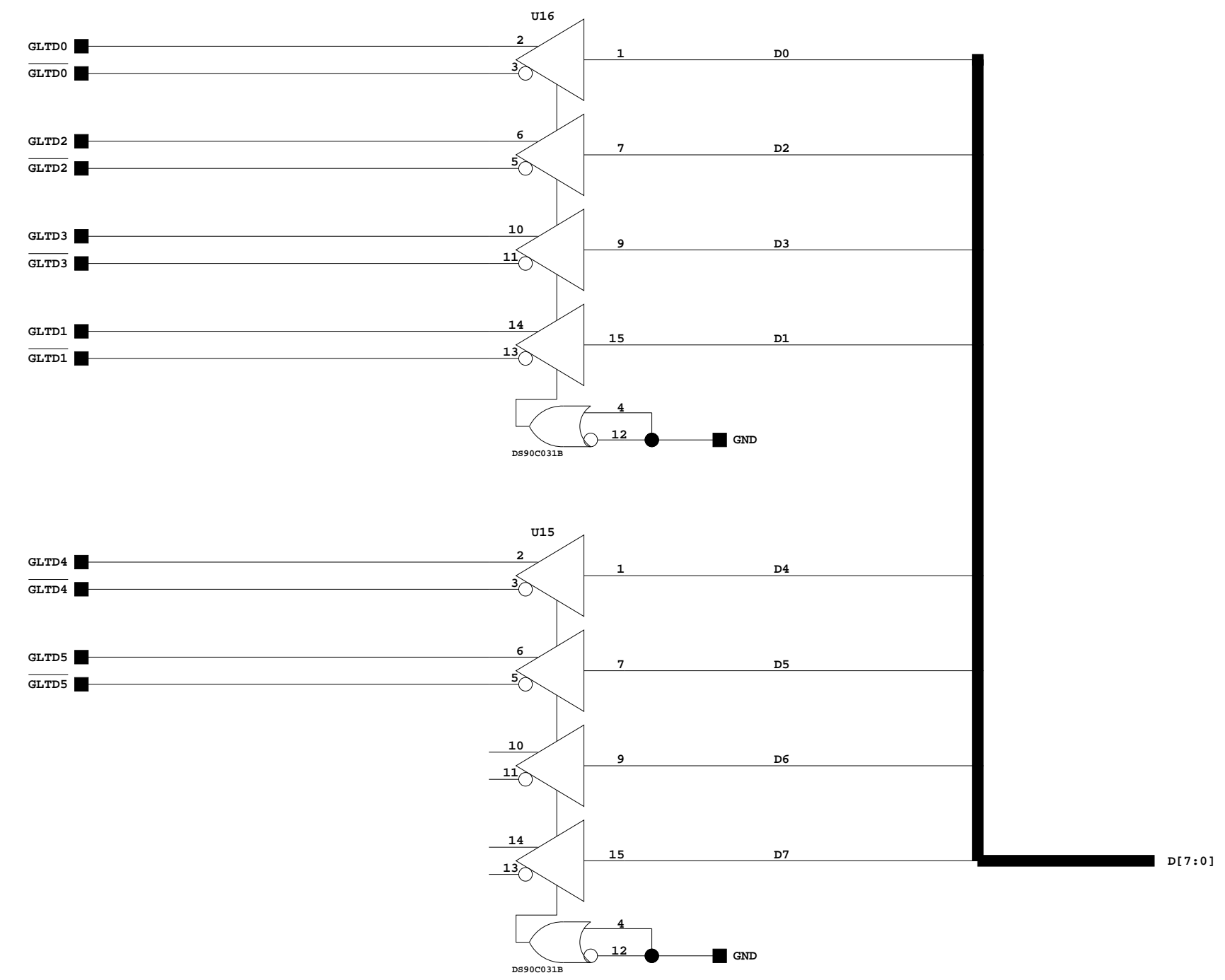

ZPD_OUT. 1
4-25-2002_9:58

BABAR
ZPDI
AUXILIARY BOARD 2

STANFORD LINEAR ACCELERATOR CENTER U.S. DEPARTMENT OF ENERGY		
STANFORD UNIVERSITY		STANFORD, CALIFORNIA
PROPRIETARY DATA OF STANFORD UNIVERSITY AND/OR U.S. DEPARTMENT OF ENERGY. RECIPIENT SHALL NOT PUBLISH THE INFORMATION WITHIN UNLESS GRANTED SPECIFIC PERMISSION OF STANFORD UNIVERSITY.		
DATE	DATE	APPROVALS
BY	04/09/02	
BY		
BY		
BY		

BABAR ZPDI AUXILIARY BD 2

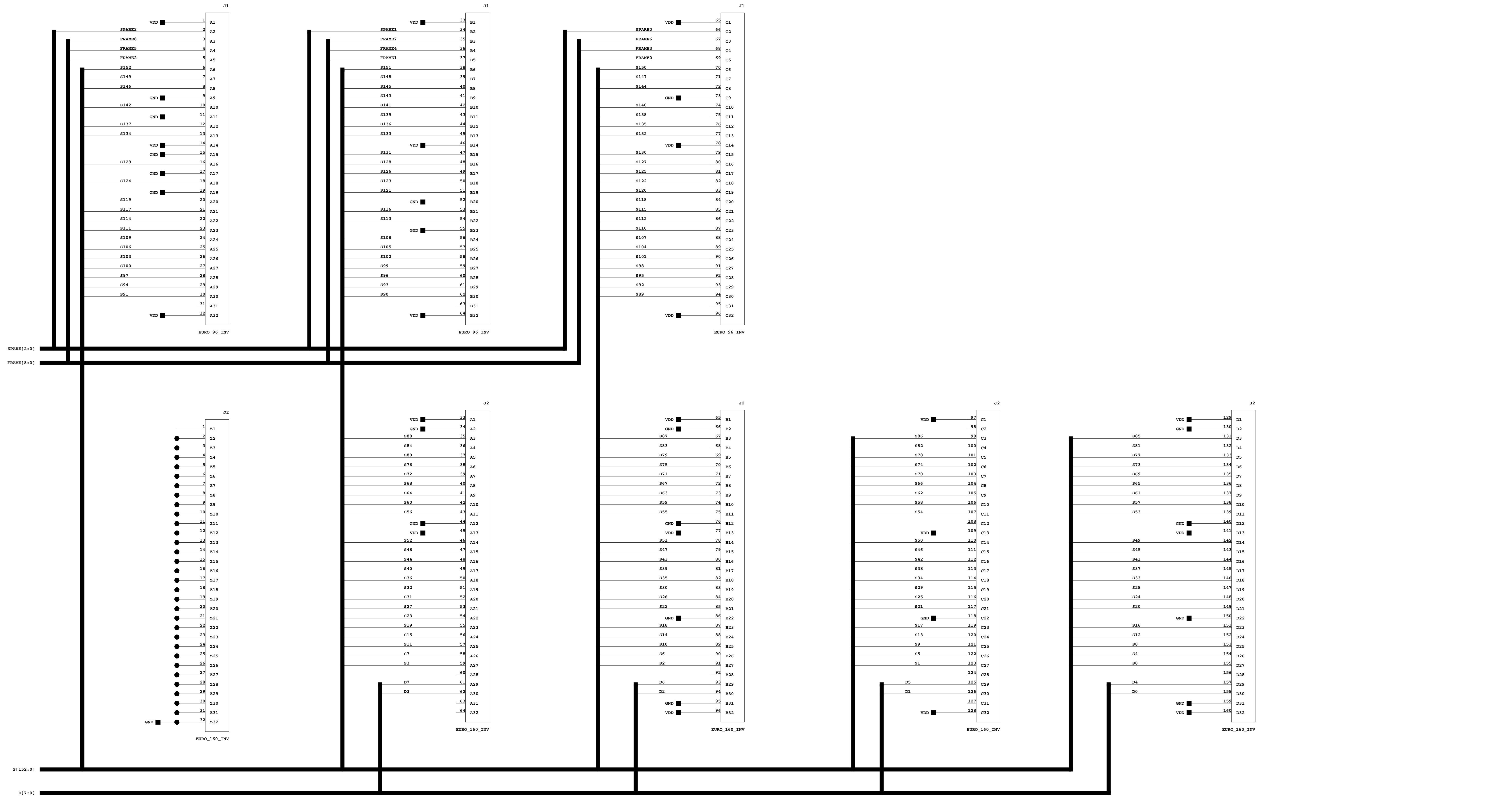

STANFORD LINEAR ACCELERATOR CENTER U.S. DEPARTMENT OF ENERGY		
STANFORD UNIVERSITY		STANFORD, CALIFORNIA
PROPRIETARY DATA OF STANFORD UNIVERSITY AND/OR U.S. DEPARTMENT OF ENERGY. RECIPIENT SHALL NOT PUBLISH THE INFORMATION WITHIN UNLESS GRANTED SPECIFIC PERMISSION OF STANFORD UNIVERSITY.		
DATE	DATE	APPROVALS
04/09/02		
BY	DATE	APPROVALS
Jeff Olsen	04/09/02	
CHKD		

BABAR
ZPDI
AUXILIARY BOARD 2

SD-350-755-23-R01

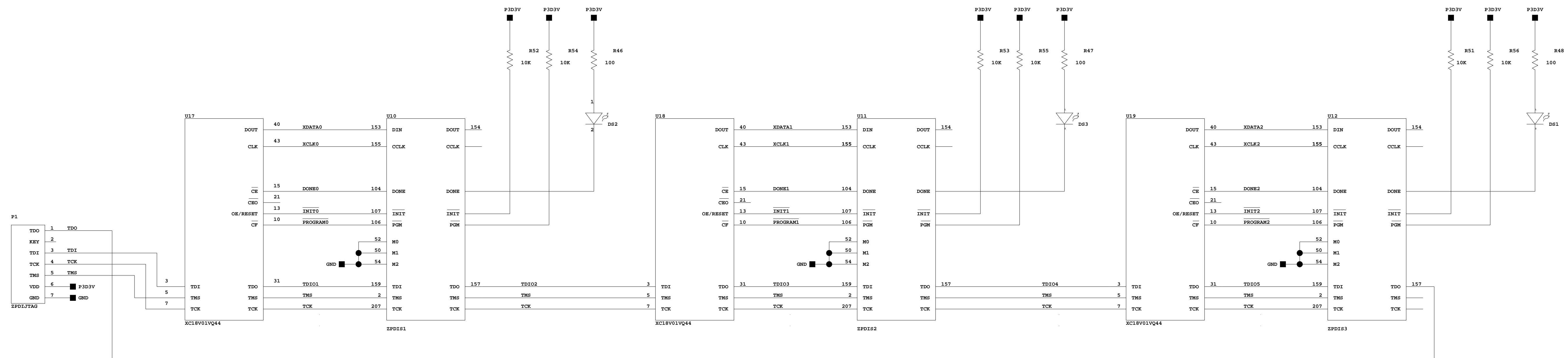

STANFORD LINEAR ACCELERATOR CENTER U.S. DEPARTMENT OF ENERGY		
STANFORD UNIVERSITY	STANFORD, CALIFORNIA	
PROPRIETARY DATA OF STANFORD UNIVERSITY AND/OR U.S. DEPARTMENT OF ENERGY. RECIPIENT SHALL NOT PUBLISH THE INFORMATION WITHIN UNLESS GRANTED SPECIFIC PERMISSION OF STANFORD UNIVERSITY.		
DATE	APPROVALS	
04/09/02		
BY: Jeff Olsen		
CHKD:		

BABAR
ZPDI
AUXILIARY BOARD 2

SD-350-755-23-R01

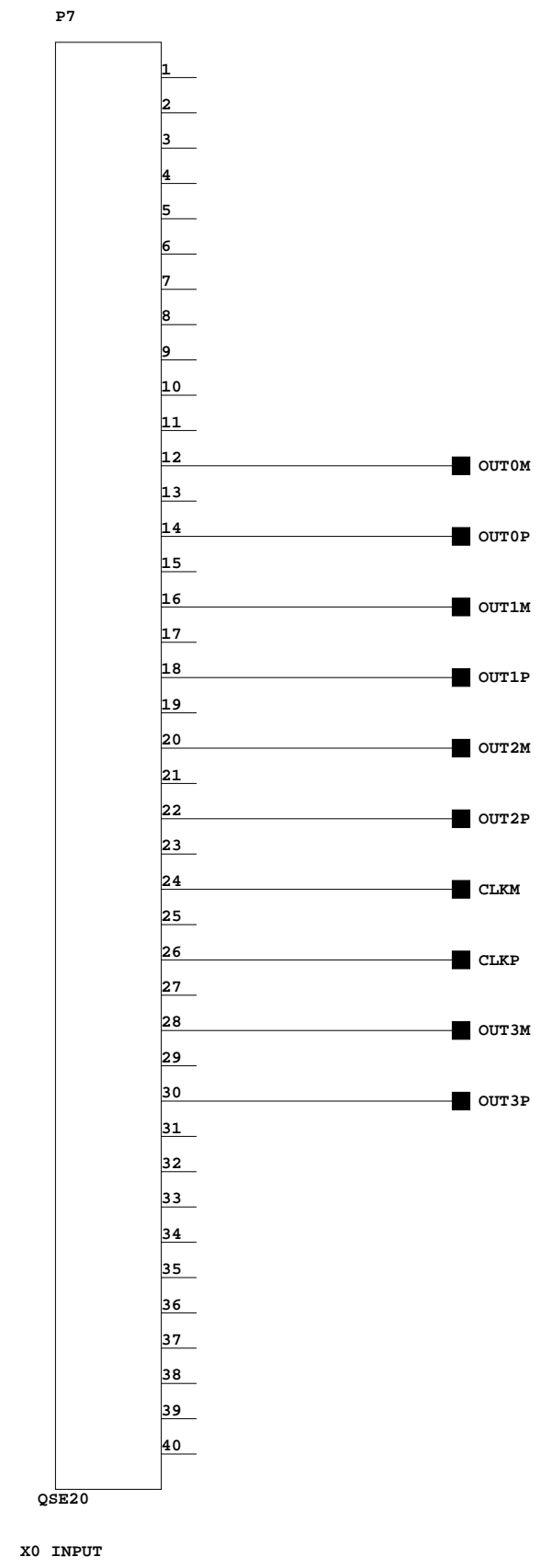

ZPDIN. 1
3-5-2003_13:34

BABAR ZPDI AUXILIARY BD 2

STANFORD LINEAR ACCELERATOR CENTER U.S. DEPARTMENT OF ENERGY		
STANFORD UNIVERSITY	STANFORD, CALIFORNIA	
<small>PROPRIETARY DATA OF STANFORD UNIVERSITY AND/OR U.S. DEPARTMENT OF ENERGY. RECIPIENT SHALL NOT PUBLISH THE INFORMATION WITHIN UNLESS GRANTED SPECIFIC PERMISSION OF STANFORD UNIVERSITY.</small>		
DATE	APPROVALS	
BY: Jeff Olsen	04/09/02	
CHKD:		
DATE:		
CHKD:		

SHEET 20 OF 29
BABAR ZPDI AUXILIARY BOARD 2
SD-350-755-23-R01
D

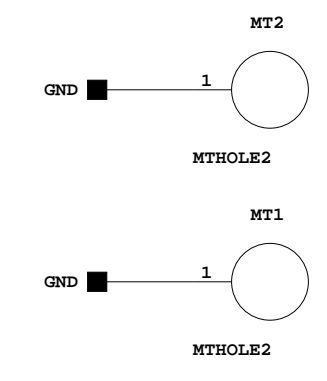
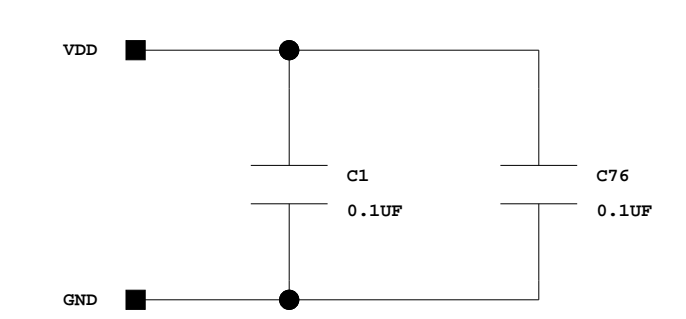
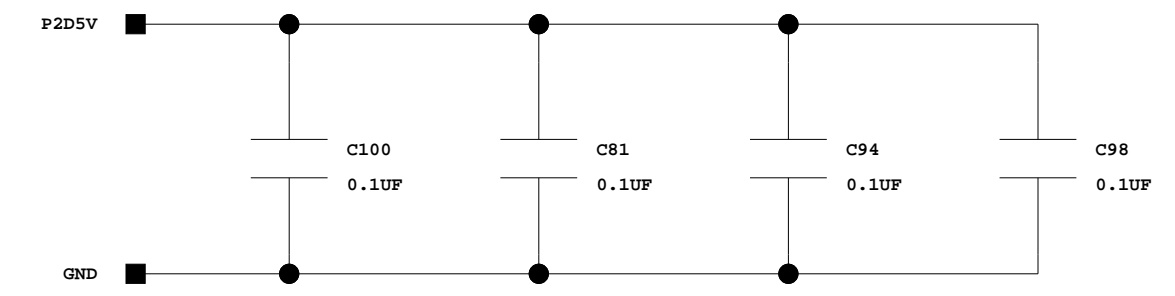
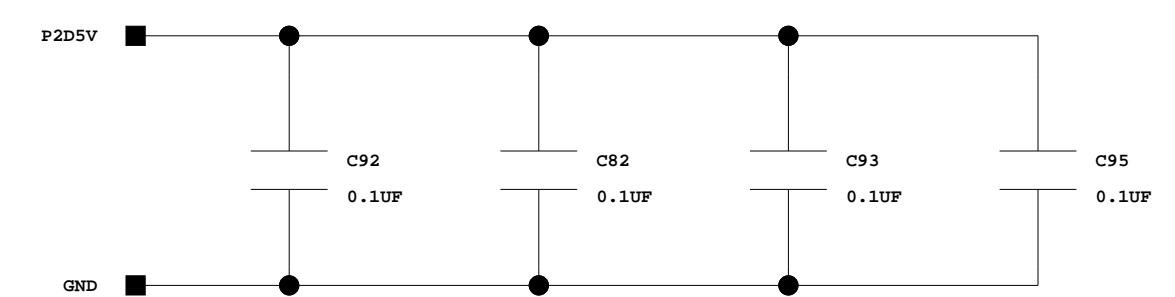
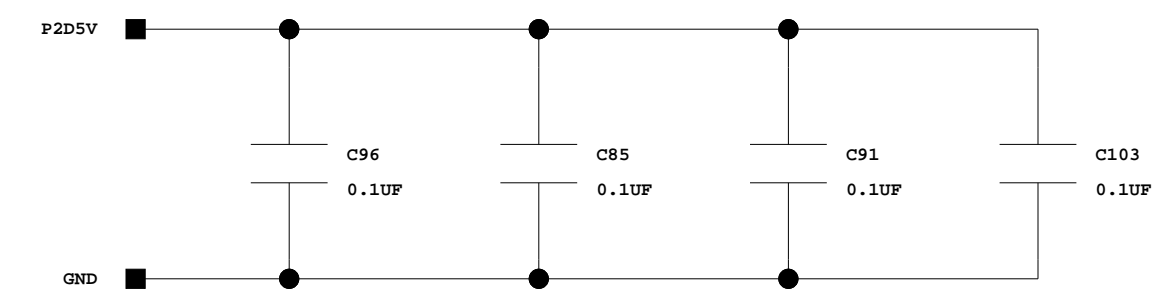
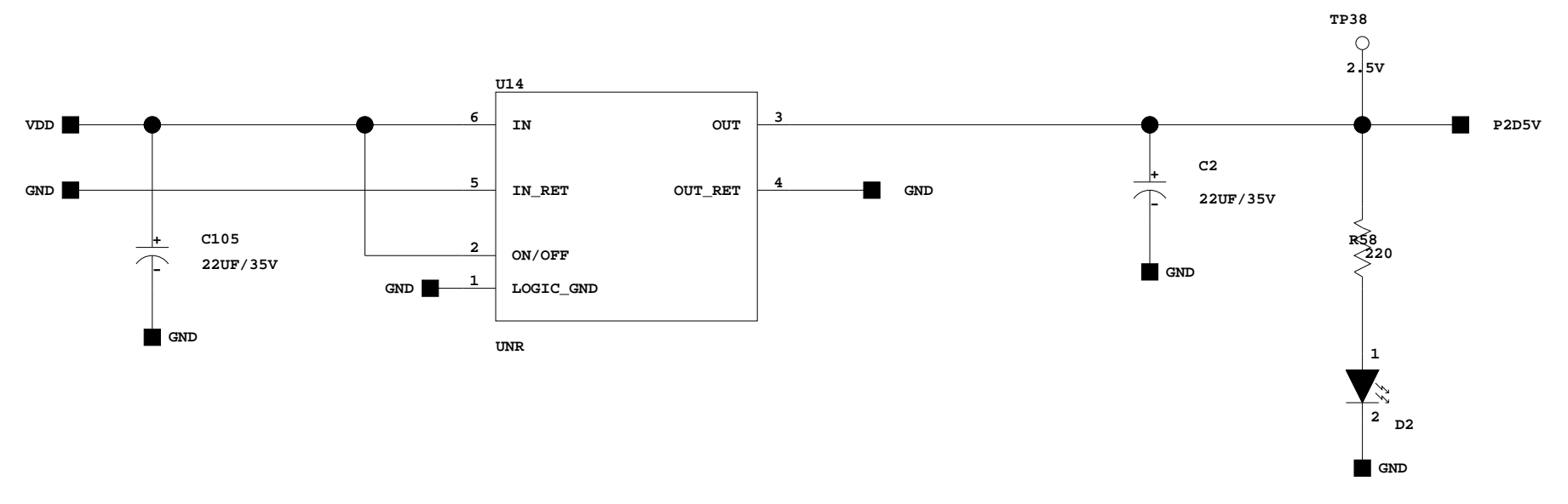
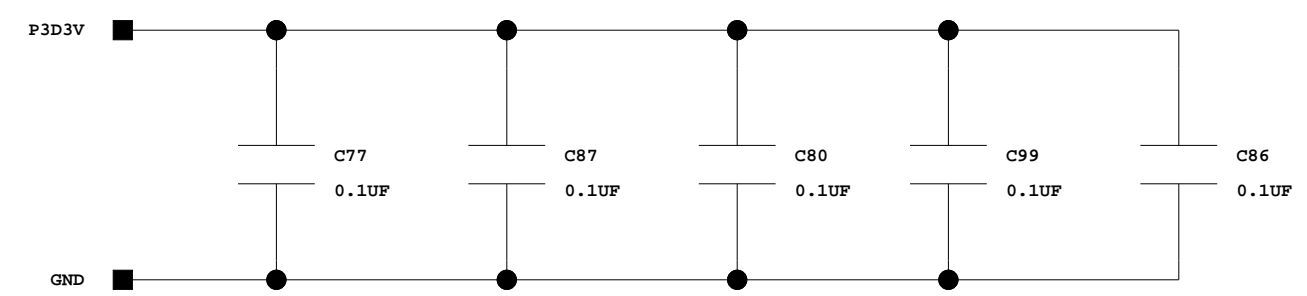
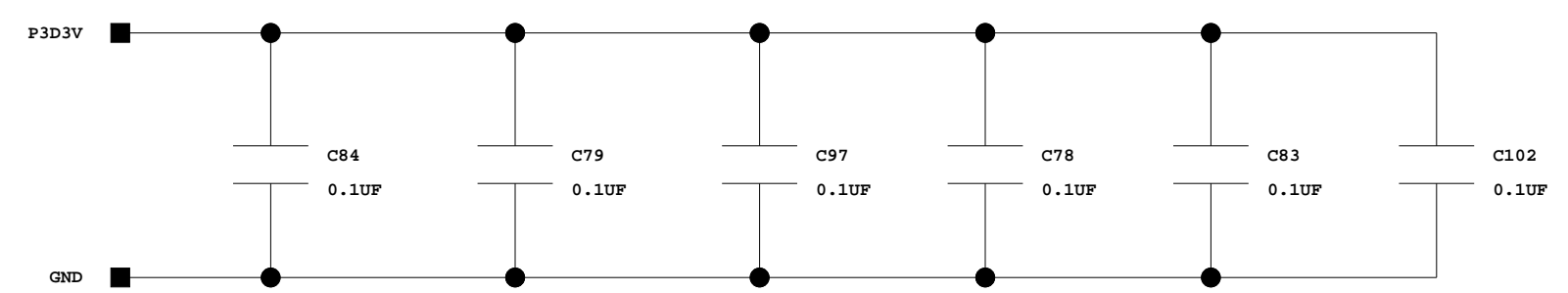
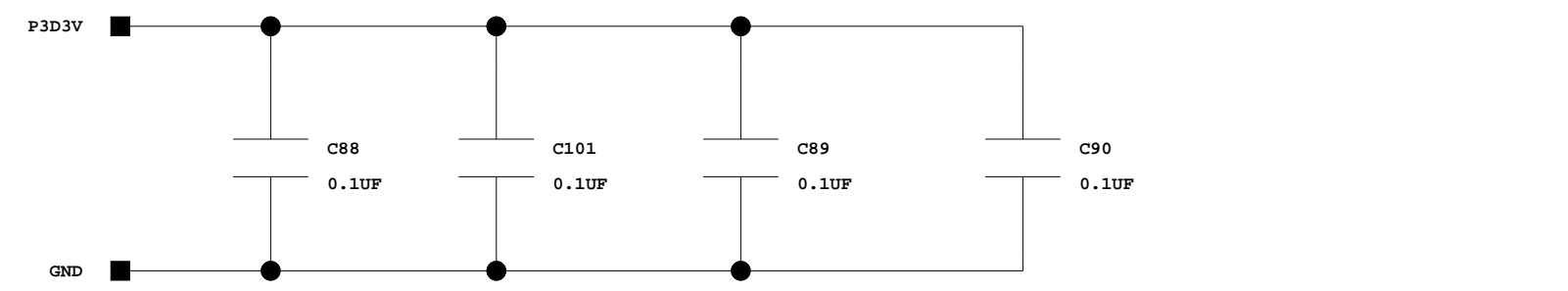
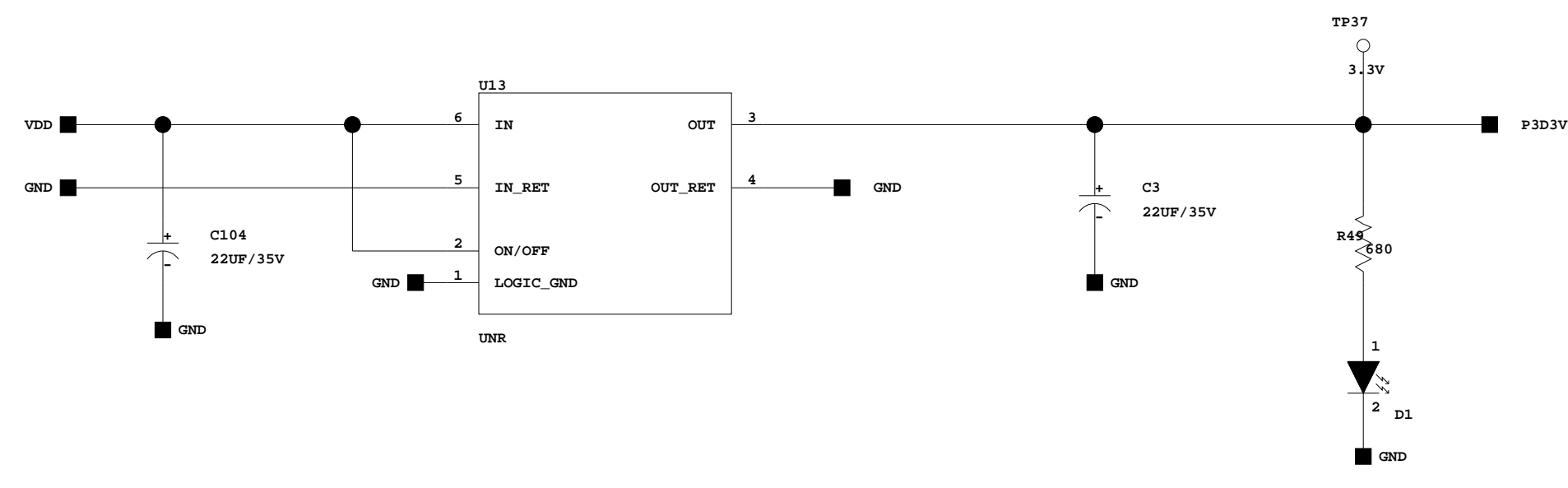

STANFORD LINEAR ACCELERATOR CENTER
U.S. DEPARTMENT OF ENERGY
STANFORD UNIVERSITY STANFORD, CALIFORNIA

PROPRIETARY DATA OF STANFORD UNIVERSITY AND/OR U.S. DEPARTMENT OF ENERGY. RECIPIENT SHALL NOT PUBLISH THE INFORMATION WITHIN UNLESS GRANTED SPECIFIC PERMISSION OF STANFORD UNIVERSITY.

DATE	APPROVALS
04/09/02	

DRWR	Jeff Olsen
CHKD	

BABAR
ZPDI
AUXILIARY BOARD 2

BABAR ZPDI AUXILIARY BD 2

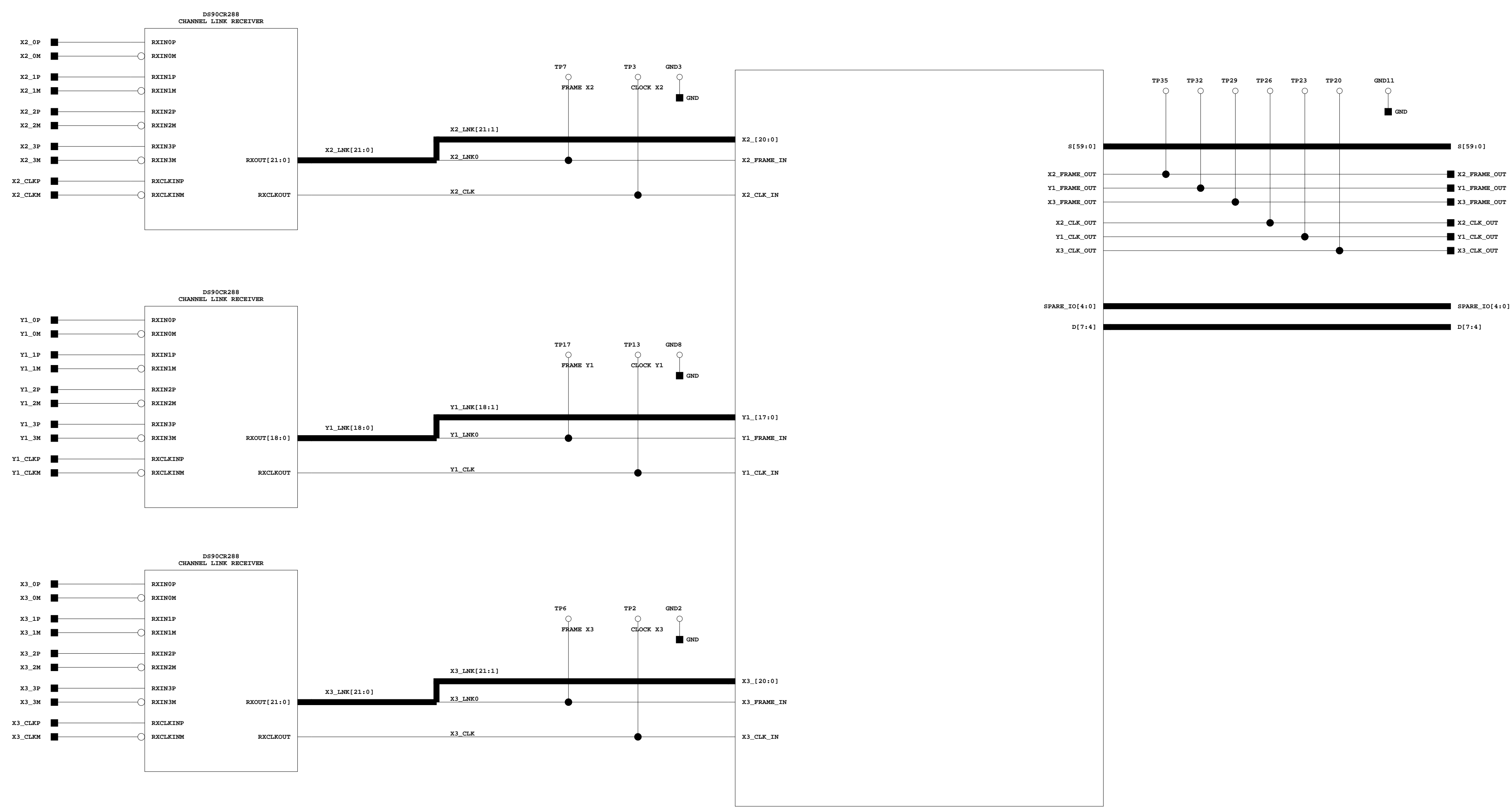

CHANNEL2. 1
4-25-2002_13:03

STANFORD LINEAR ACCELERATOR CENTER U.S. DEPARTMENT OF ENERGY		
STANFORD UNIVERSITY		STANFORD, CALIFORNIA
PROPRIETARY DATA OF STANFORD UNIVERSITY AND/OR U.S. DEPARTMENT OF ENERGY. RECIPIENT SHALL NOT PUBLISH THE INFORMATION WITHIN UNLESS GRANTED SPECIFIC PERMISSION OF STANFORD UNIVERSITY.		
DATE	04/09/02	APPROVALS
BY	Jeff Olsen	
CHKD		

SHEET 7 OF 29
BABAR ZPDI AUXILIARY BOARD 2
SD-350-755-23-R01

BABAR ZPDI AUXILIARY BD 2

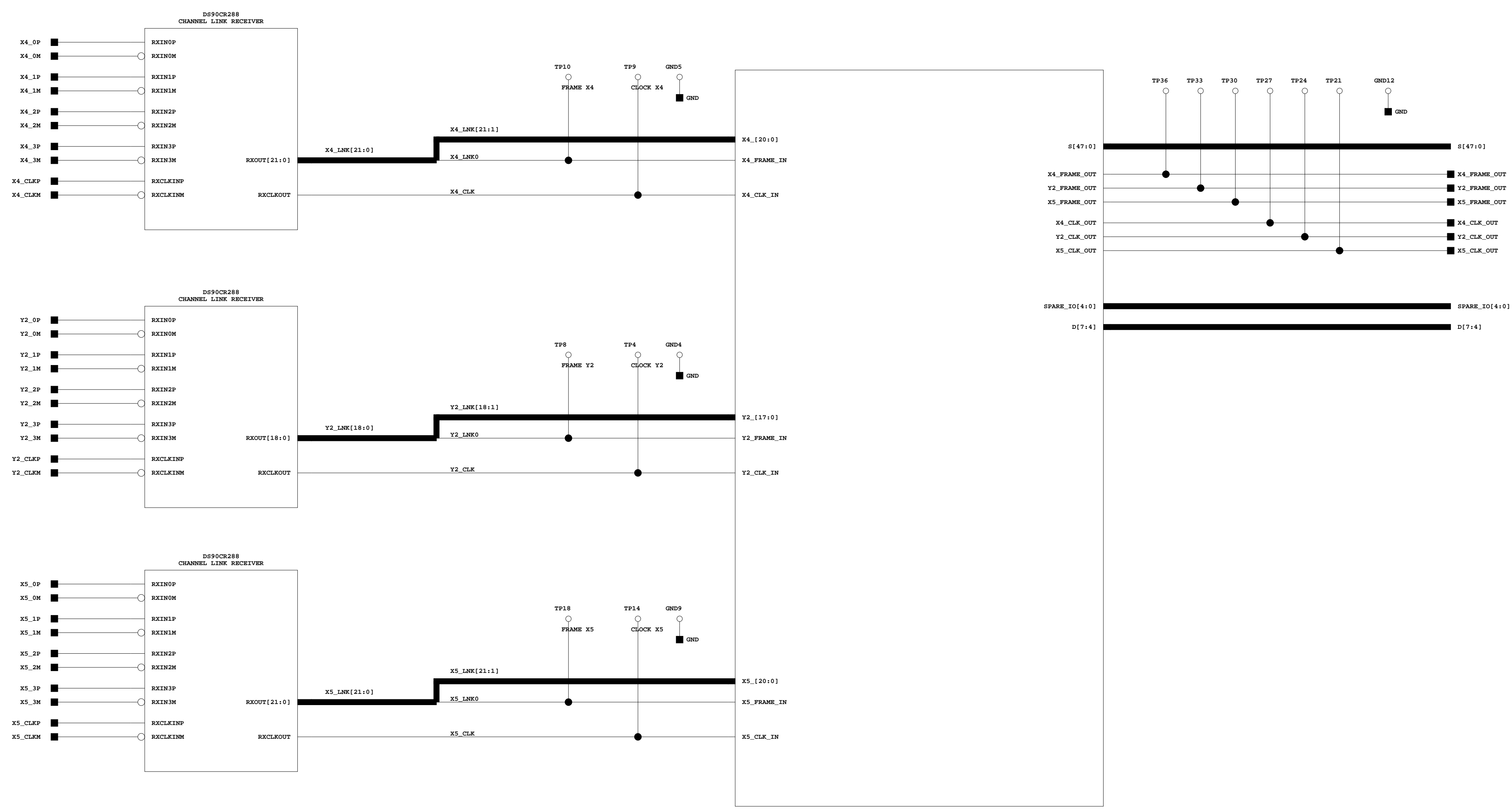

CHANNEL3. 1
4-25-2002_13:05

STANFORD LINEAR ACCELERATOR CENTER
U.S. DEPARTMENT OF ENERGY
STANFORD UNIVERSITY STANFORD, CALIFORNIA

PROPRIETARY DATA OF STANFORD UNIVERSITY AND/OR U.S. DEPARTMENT OF ENERGY. RECIPIENT SHALL NOT PUBLISH THE INFORMATION WITHIN UNLESS GRANTED SPECIFIC PERMISSION OF STANFORD UNIVERSITY.

ENGR	DATE	APPROVALS
Jeff Olsen	04/09/02	
DATE		
CHKD		

BABAR
ZPDI
AUXILIARY BOARD 2

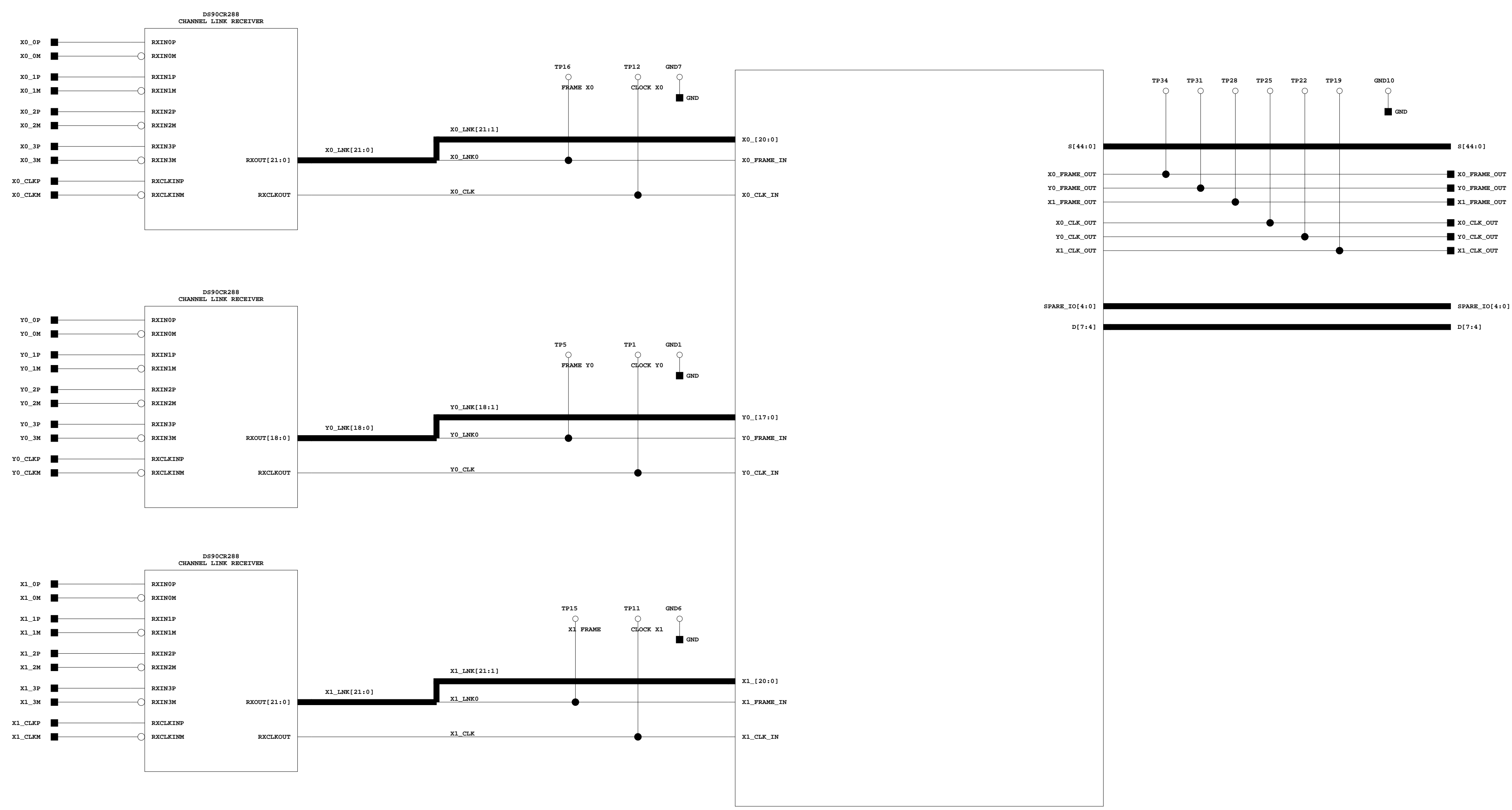

CHANNEL1. 1
4-25-2002_13:01

STANFORD LINEAR ACCELERATOR CENTER U.S. DEPARTMENT OF ENERGY		
STANFORD UNIVERSITY		STANFORD, CALIFORNIA
PROPRIETARY DATA OF STANFORD UNIVERSITY AND/OR U.S. DEPARTMENT OF ENERGY. RECIPIENT SHALL NOT PUBLISH THE INFORMATION WITHIN UNLESS GRANTED SPECIFIC PERMISSION OF STANFORD UNIVERSITY.		
DATE	DATE	APPROVALS
BY	04/09/02	
CHKD		
BY		

BABAR
ZPDI
AUXILIARY BOARD 2

SD-350-755-23-R01

BABAR ZPDI AUXILIARY BD 2

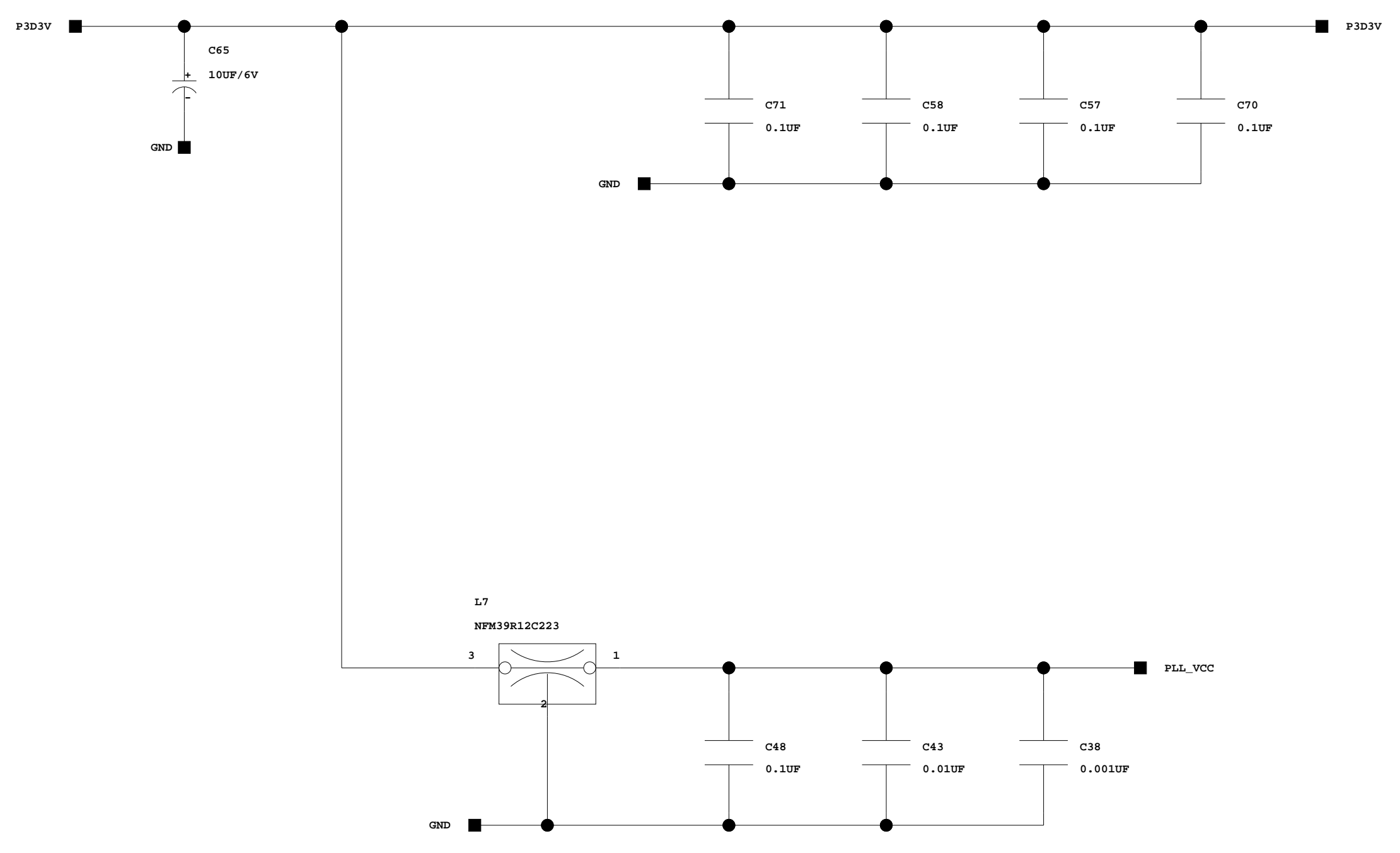
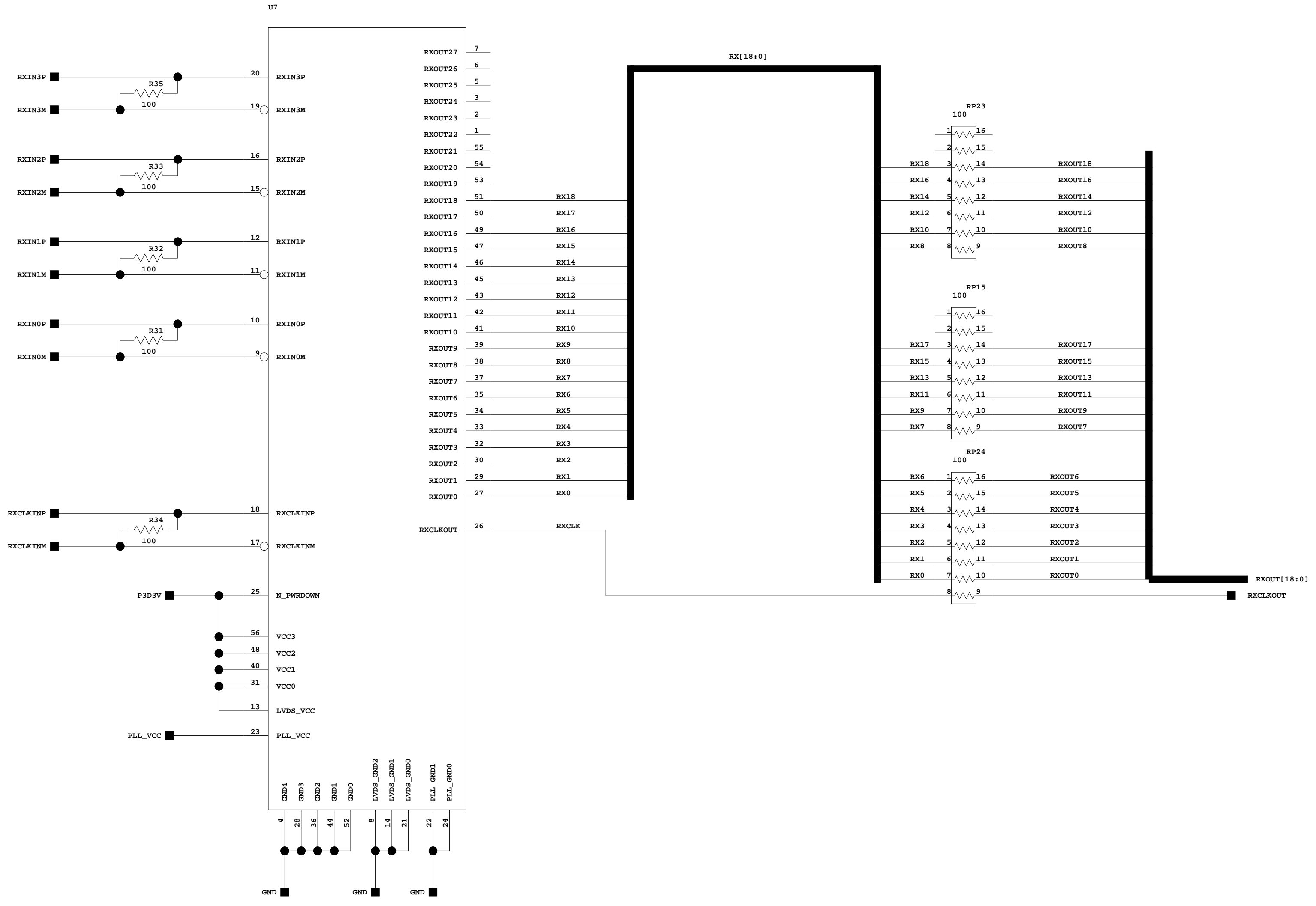

BABAR ZPDI AUXILIARY BD 2

LINK18. 1
4-25-2002_9:58

SHEET 8 OF 29

STANFORD LINEAR ACCELERATOR CENTER U.S. DEPARTMENT OF ENERGY	
STANFORD UNIVERSITY	STANFORD, CALIFORNIA
PROPRIETARY DATA OF STANFORD UNIVERSITY AND/OR U.S. DEPARTMENT OF ENERGY. RECIPIENT SHALL NOT PUBLISH THE INFORMATION WITHIN UNLESS GRANTED SPECIFIC PERMISSION OF STANFORD UNIVERSITY.	
DATE	APPROVALS
04/09/02	
BY	
Jeff Olsen	
CHKD	

BABAR
ZPDI
AUXILIARY BOARD 2

SD-350-755-23-R01

D

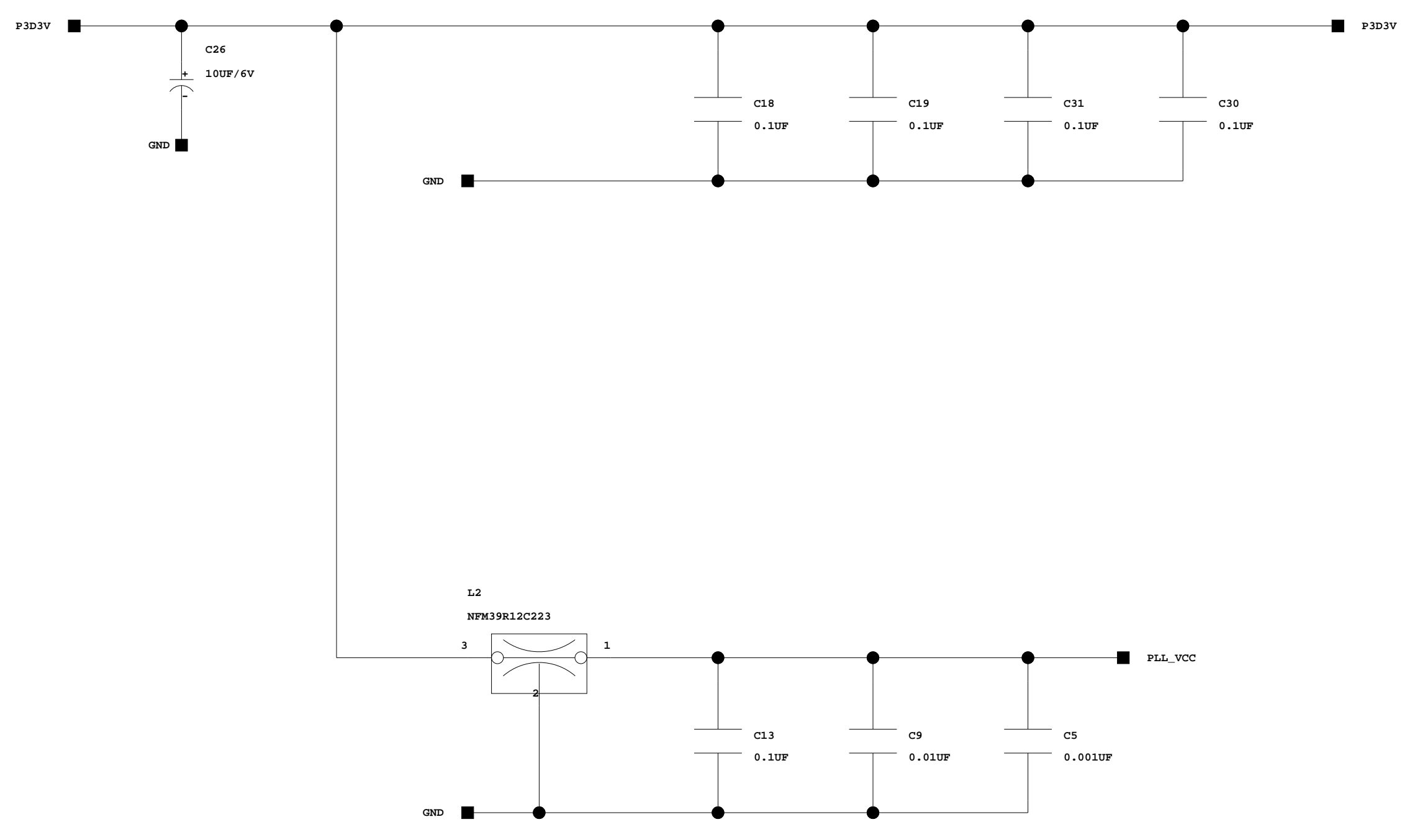
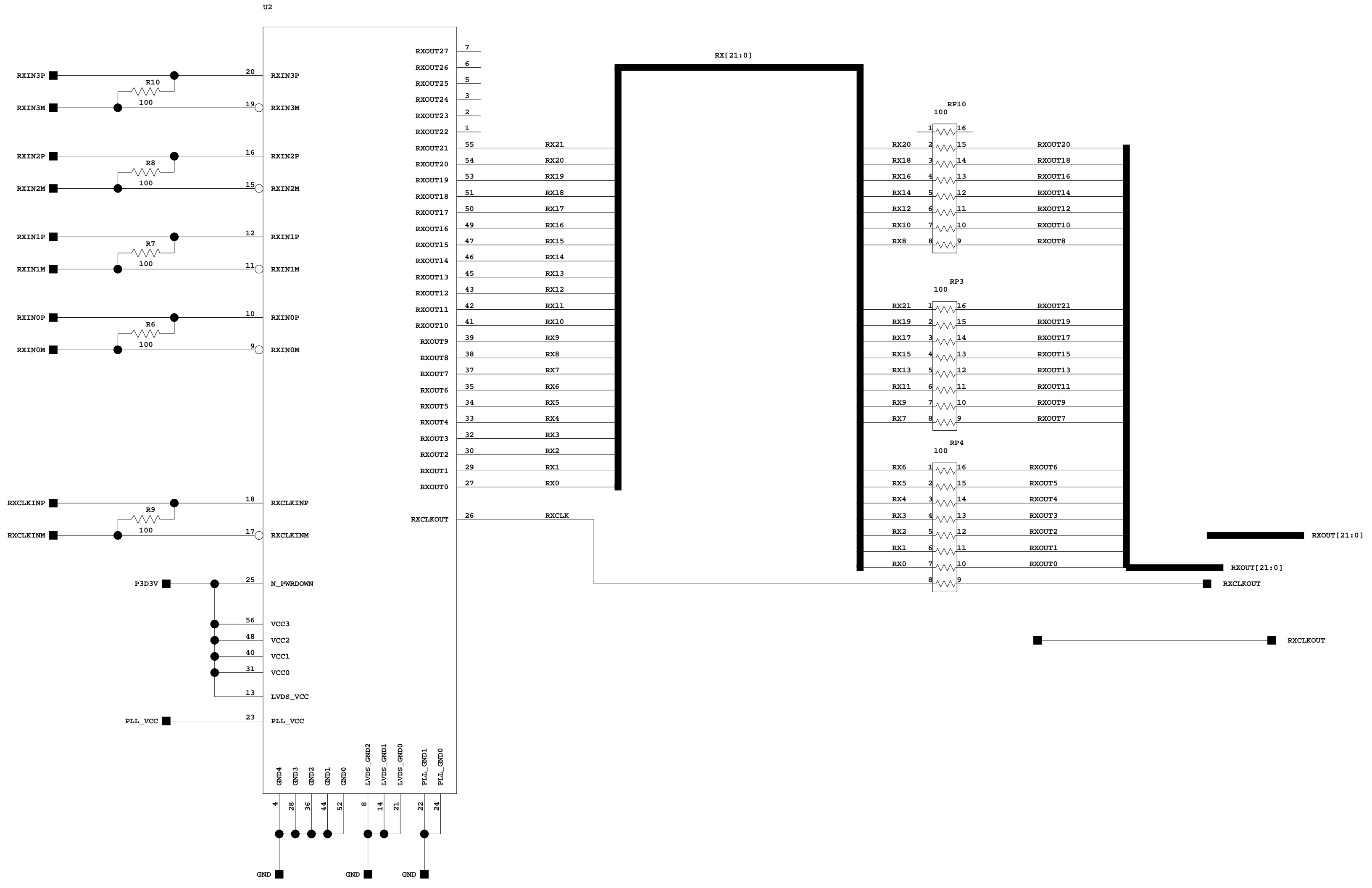

BABAR ZPDI AUXILIARY BD 2

LINK21. 1
4-25-2002_9:58

SHEET 10 OF 29

STANFORD LINEAR ACCELERATOR CENTER U.S. DEPARTMENT OF ENERGY		STANFORD, CALIFORNIA
PROPRIETARY DATA OF STANFORD UNIVERSITY AND/OR U.S. DEPARTMENT OF ENERGY. RECIPIENT SHALL NOT PUBLISH THE INFORMATION WITHIN UNLESS GRANTED SPECIFIC PERMISSION OF STANFORD UNIVERSITY.		
ENGR	DATE	APPROVALS
Jeff Olsen	04/09/02	
DATE		
CHKD		

BABAR
ZPDI
AUXILIARY BOARD 2

SD-350-755-23-R01

D

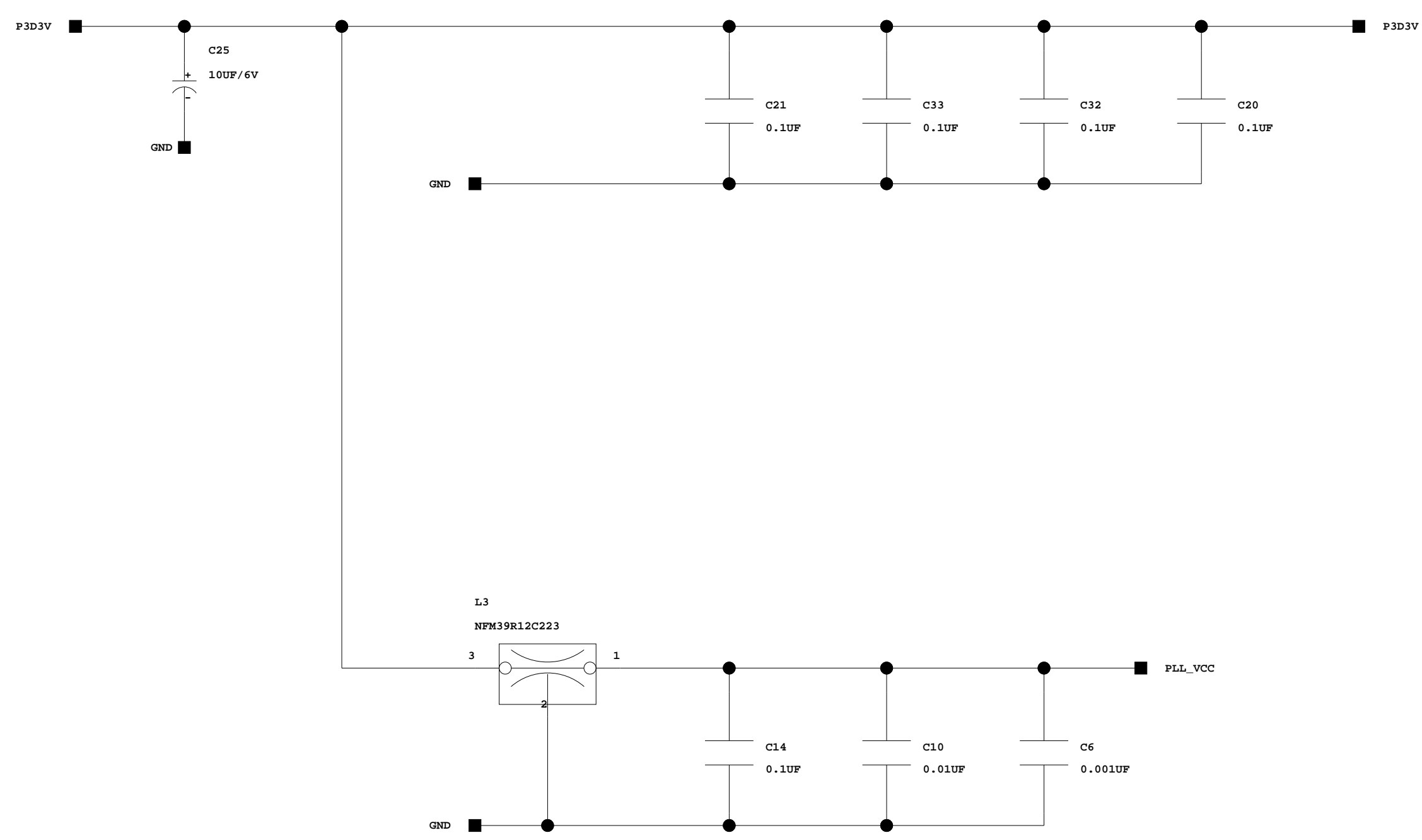
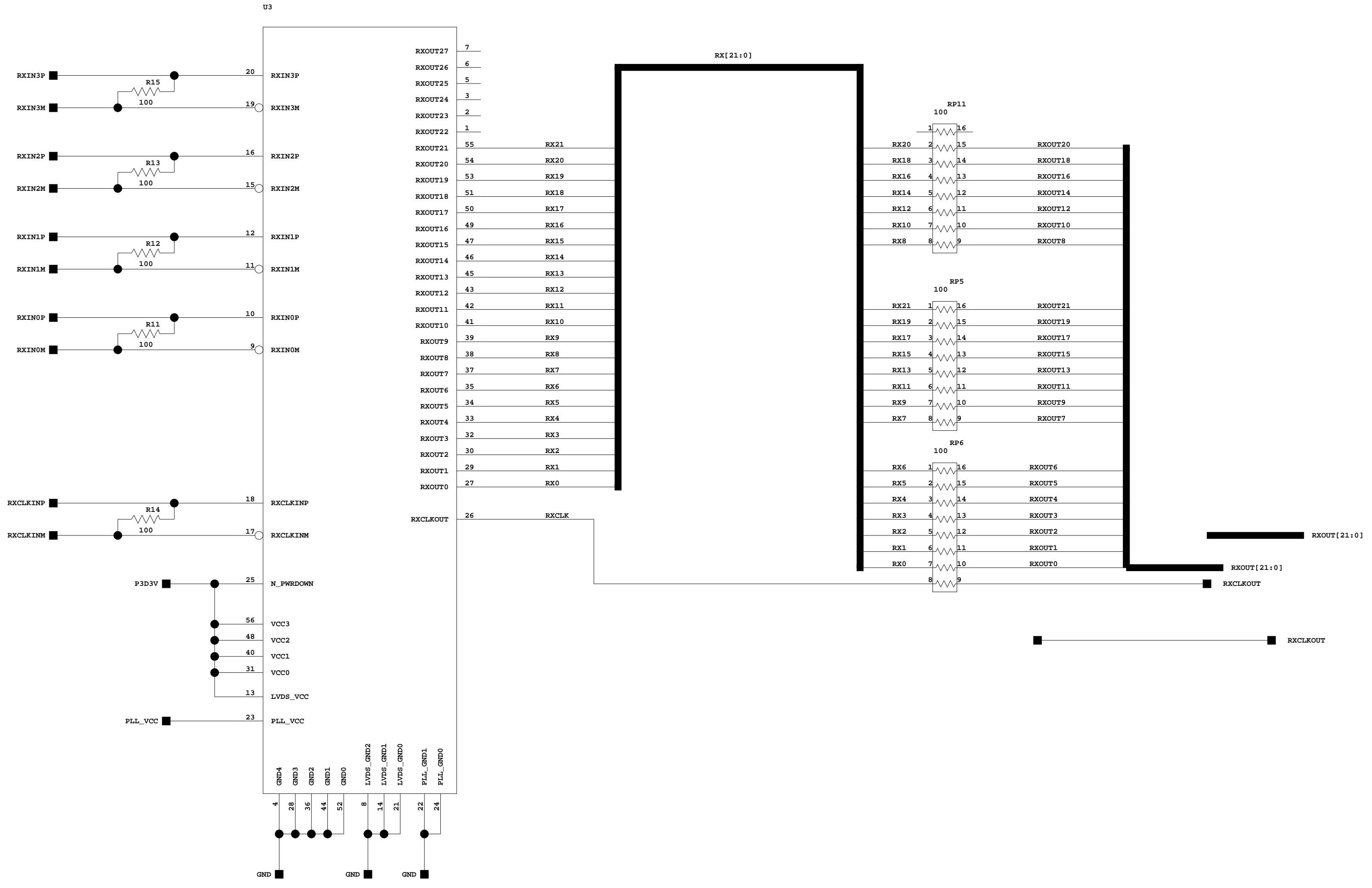

BABAR ZPDI AUXILIARY BD 2

LINK21. 1
4-25-2002_9:58

SHEET 9 OF 29

STANFORD LINEAR ACCELERATOR CENTER U.S. DEPARTMENT OF ENERGY		STANFORD, CALIFORNIA
PROPRIETARY DATA OF STANFORD UNIVERSITY AND/OR U.S. DEPARTMENT OF ENERGY. RECIPIENT SHALL NOT PUBLISH THE INFORMATION WITHIN UNLESS GRANTED SPECIFIC PERMISSION OF STANFORD UNIVERSITY.		
ENGR	DATE	APPROVALS
Jeff Olsen	04/09/02	
DATE		
CHKD		

BABAR
ZPDI
AUXILIARY BOARD 2

SD-350-755-23-R01

D

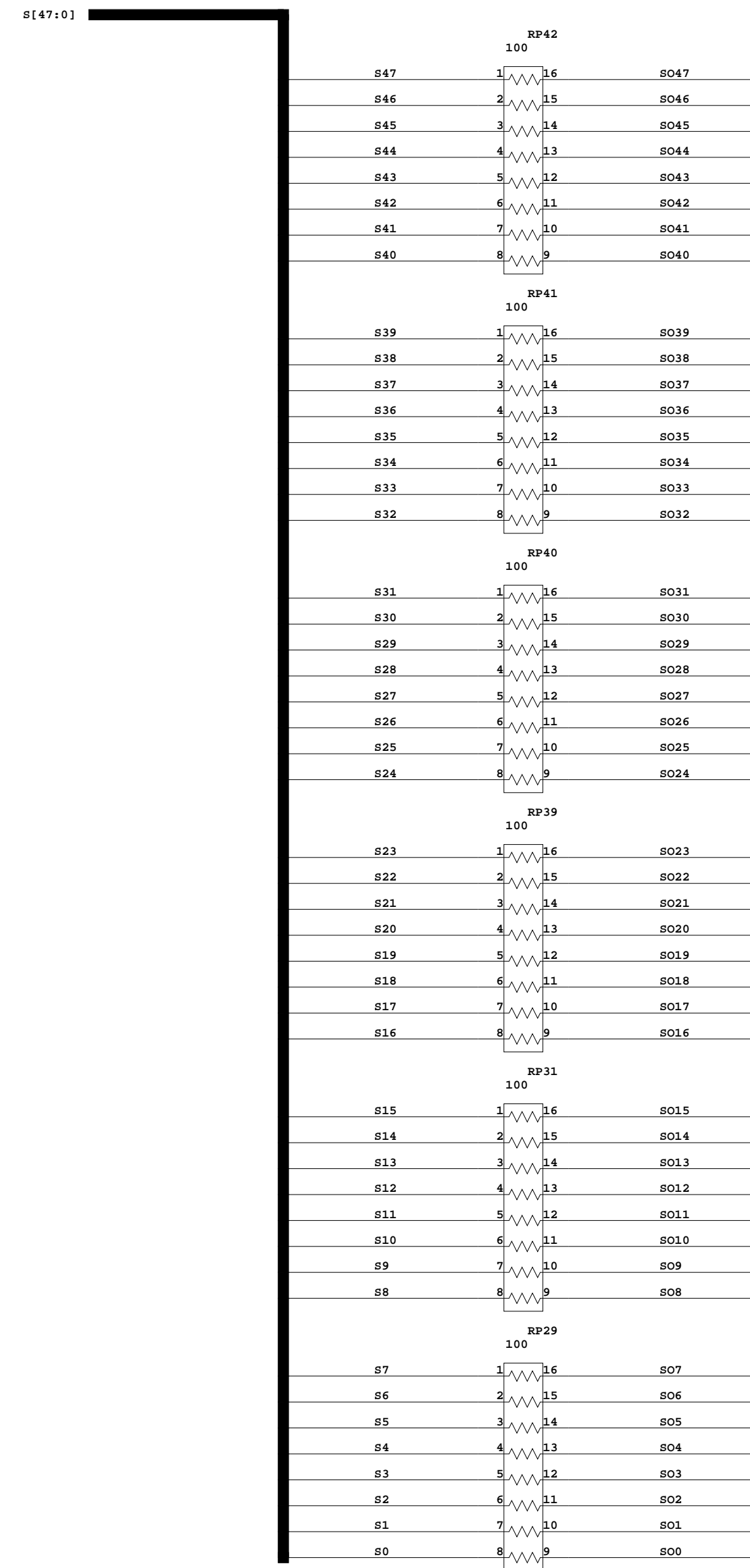

SO[57:0]

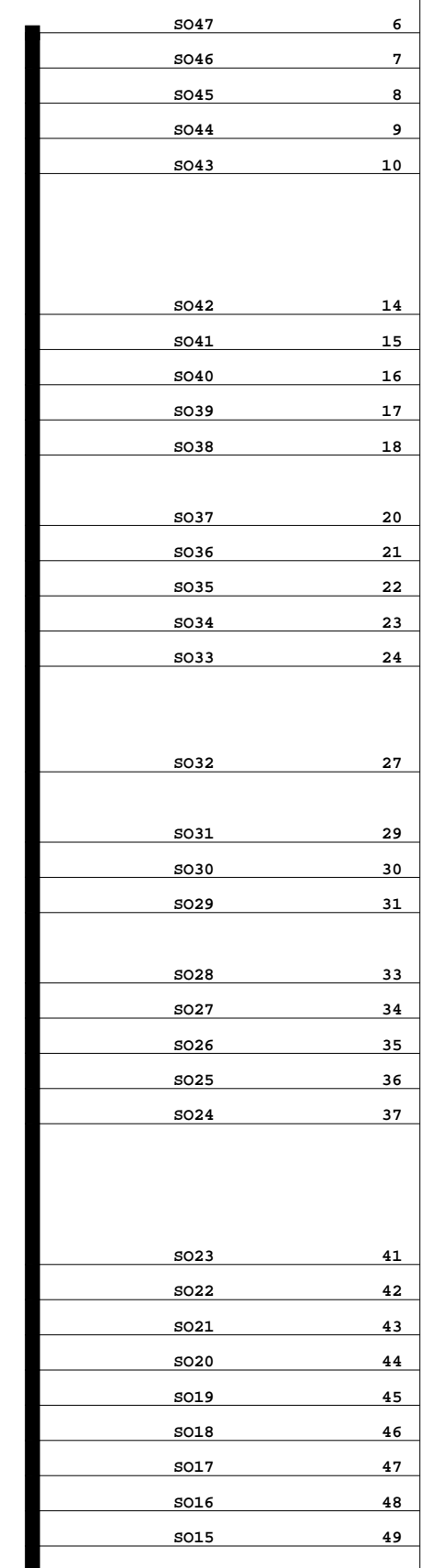

U12

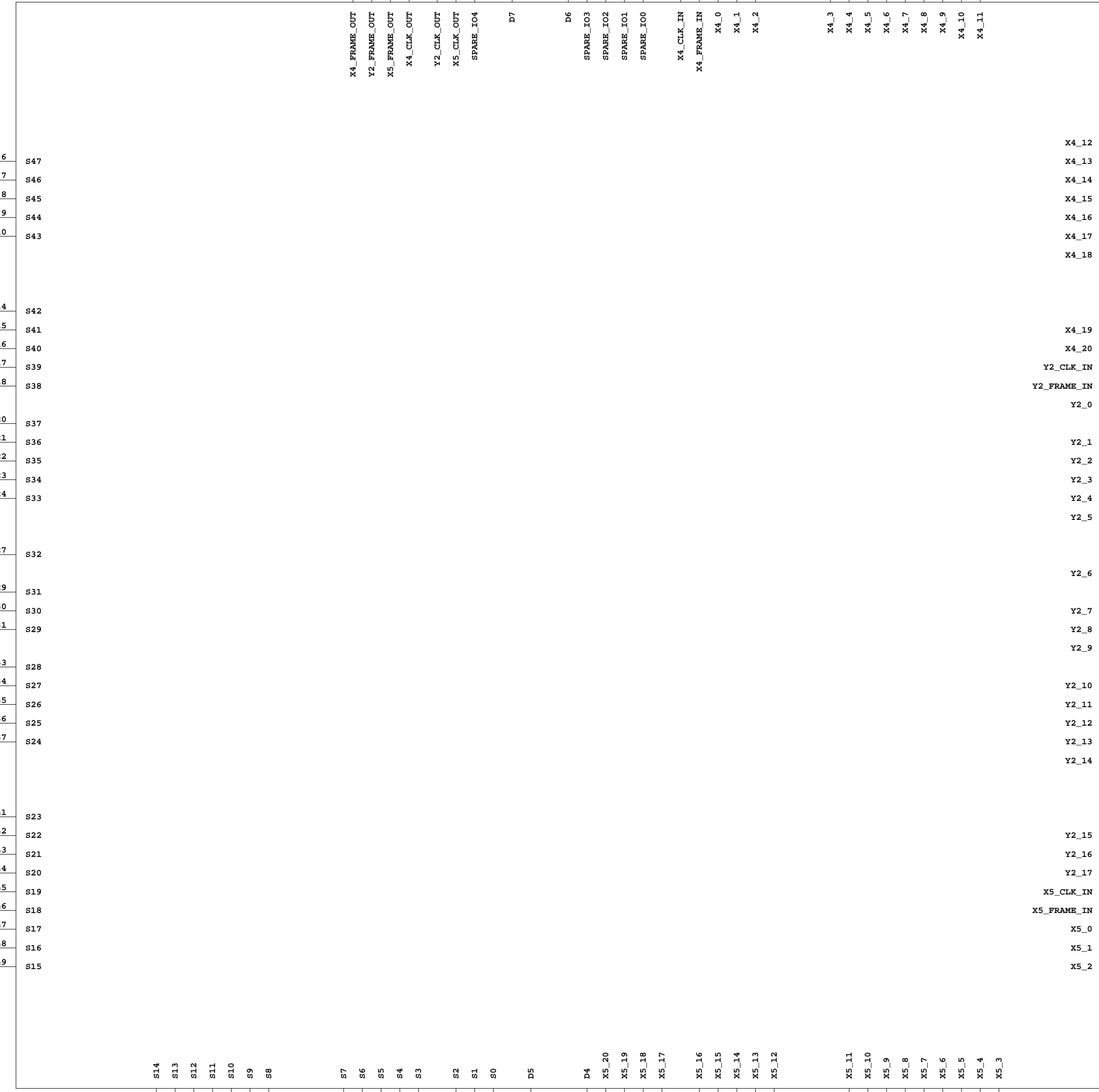

S014	S014
S013	S013
S012	S012
S011	S011
S010	S010
S009	S009
S008	S008
S007	S007
S006	S006
S005	S005
S004	S004
S003	S003
S002	S002
S001	S001
S000	S000
S07	S07
S06	S06
S05	S05
S04	S04
S03	S03
S02	S02
S01	S01
S00	S00
S05	S05
S04	S04
S03	S03
S02	S02
S01	S01
S00	S00
S05	S05
S04	S04
S03	S03
S02	S02
S01	S01
S00	S00
S05	S05
S04	S04
S03	S03
S02	S02
S01	S01
S00	S00

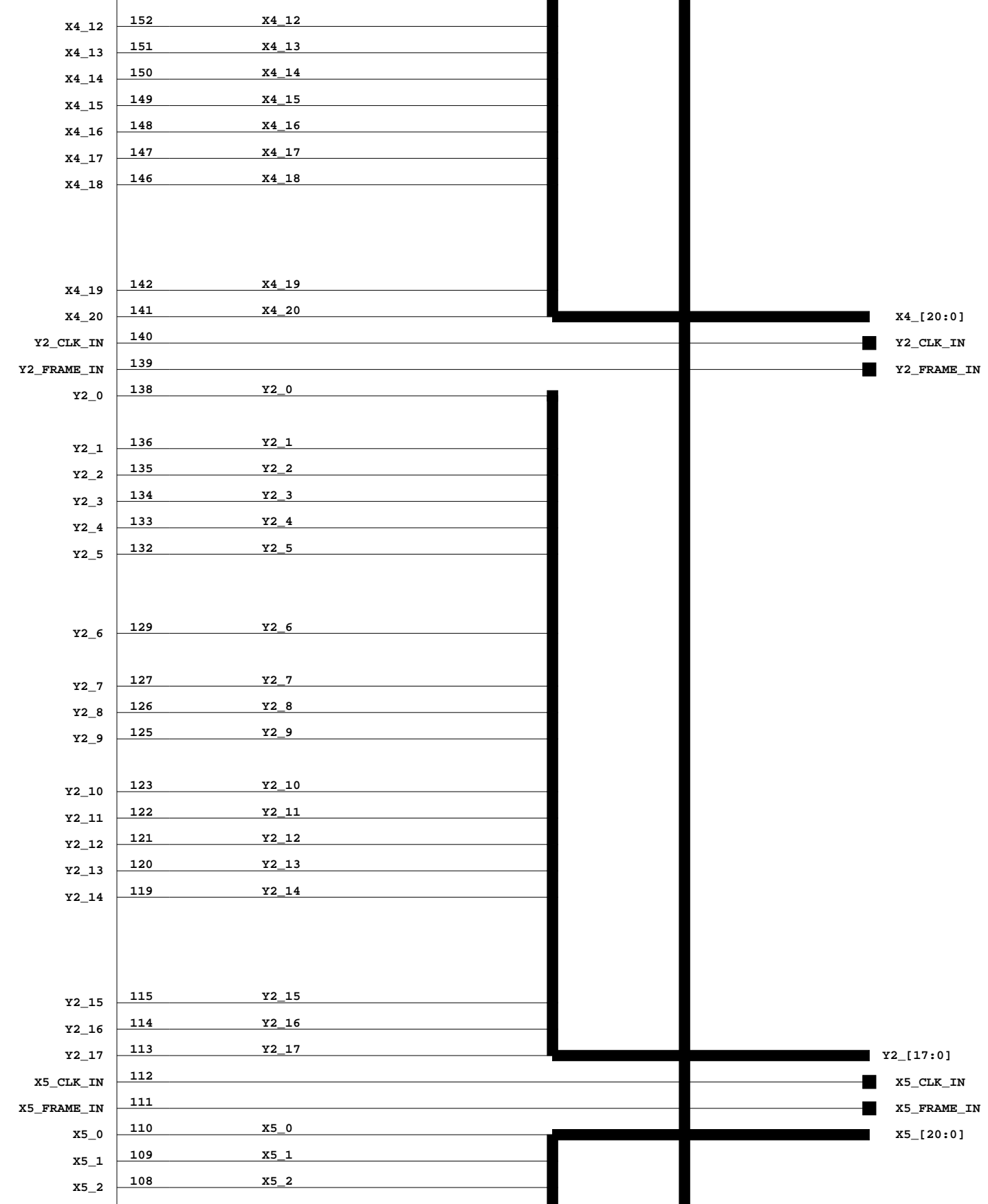

SWITCH3. 1
4-25-2002_9:58

STANFORD LINEAR ACCELERATOR CENTER
U.S. DEPARTMENT OF ENERGY

STANFORD UNIVERSITY STANFORD, CALIFORNIA

PROPRIETARY DATA OF STANFORD UNIVERSITY AND/OR U.S. DEPARTMENT OF ENERGY. RECIPIENT SHALL NOT PUBLISH THE INFORMATION WITHIN UNLESS GRANTED SPECIFIC PERMISSION OF STANFORD UNIVERSITY.

DATE	APPROVALS
04/09/02	

BABAR
ZPDI
AUXILIARY BOARD 2

SD-350-755-23-R01

BABAR ZPDI AUXILIARY BD 2

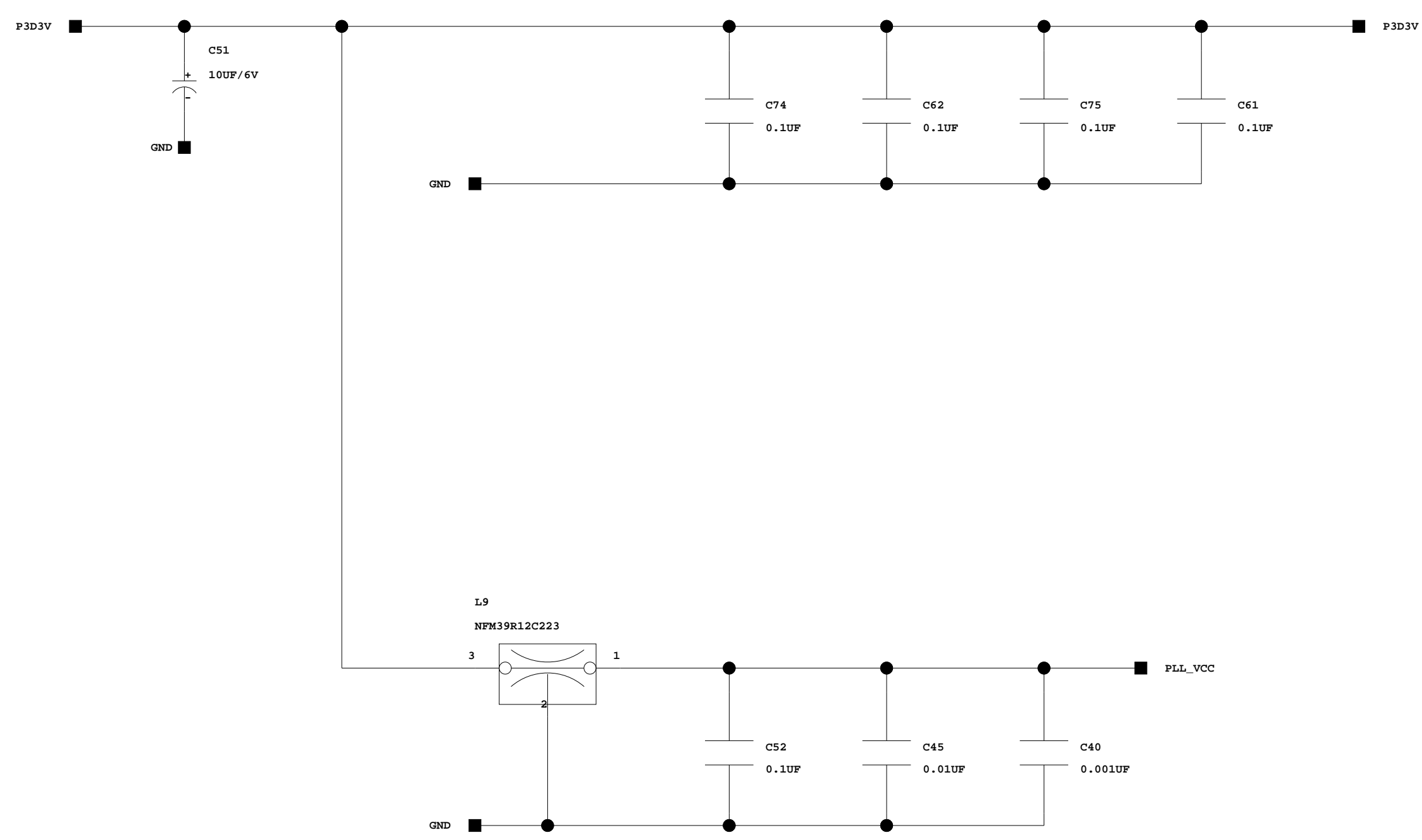
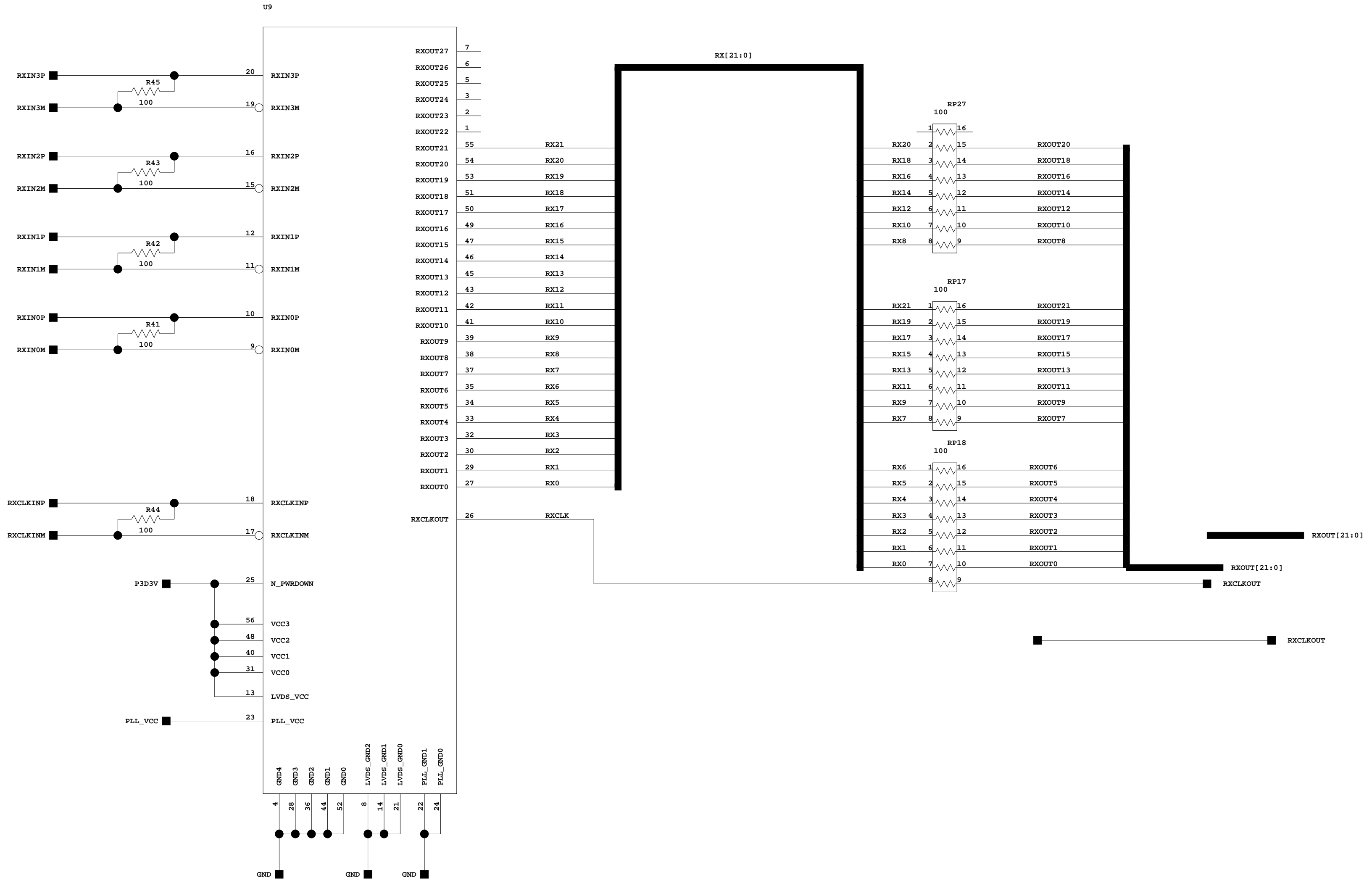

BABAR ZPDI AUXILIARY BD 2

LINK21. 1
4-25-2002_9:58

SHEET 13 OF 29

STANFORD UNIVERSITY		STANFORD, CALIFORNIA	
STANFORD LINEAR ACCELERATOR CENTER U.S. DEPARTMENT OF ENERGY			
PROPRIETARY DATA OF STANFORD UNIVERSITY AND/OR U.S. DEPARTMENT OF ENERGY. RECIPIENT SHALL NOT PUBLISH THE INFORMATION WITHIN UNLESS GRANTED SPECIFIC PERMISSION OF STANFORD UNIVERSITY.			
ENGR	DATE	APPROVALS	
Jeff Olsen	04/09/02		
DATE			
CHKD			

BABAR
ZPDI
AUXILIARY BOARD 2
SD-350-755-23-R01

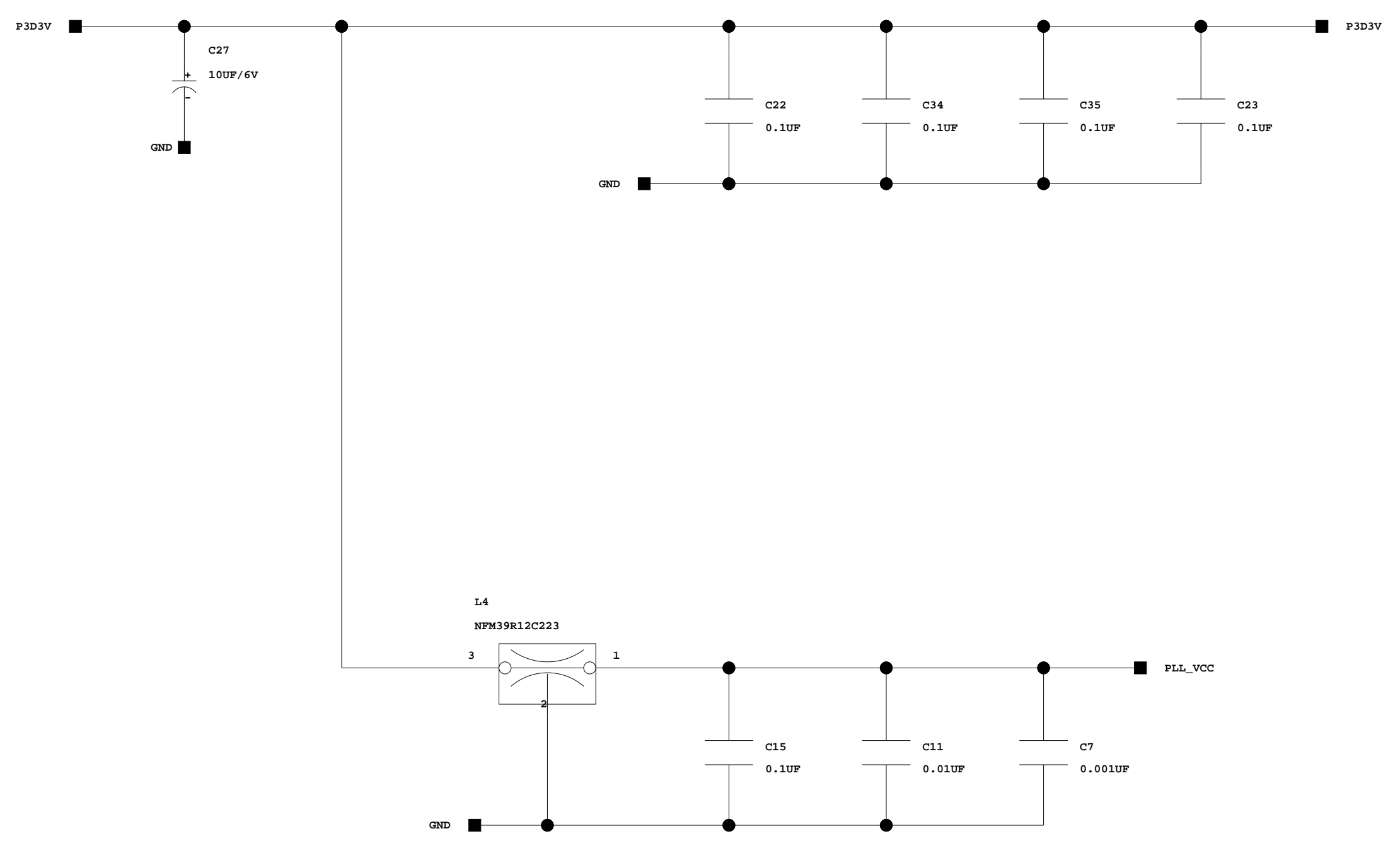
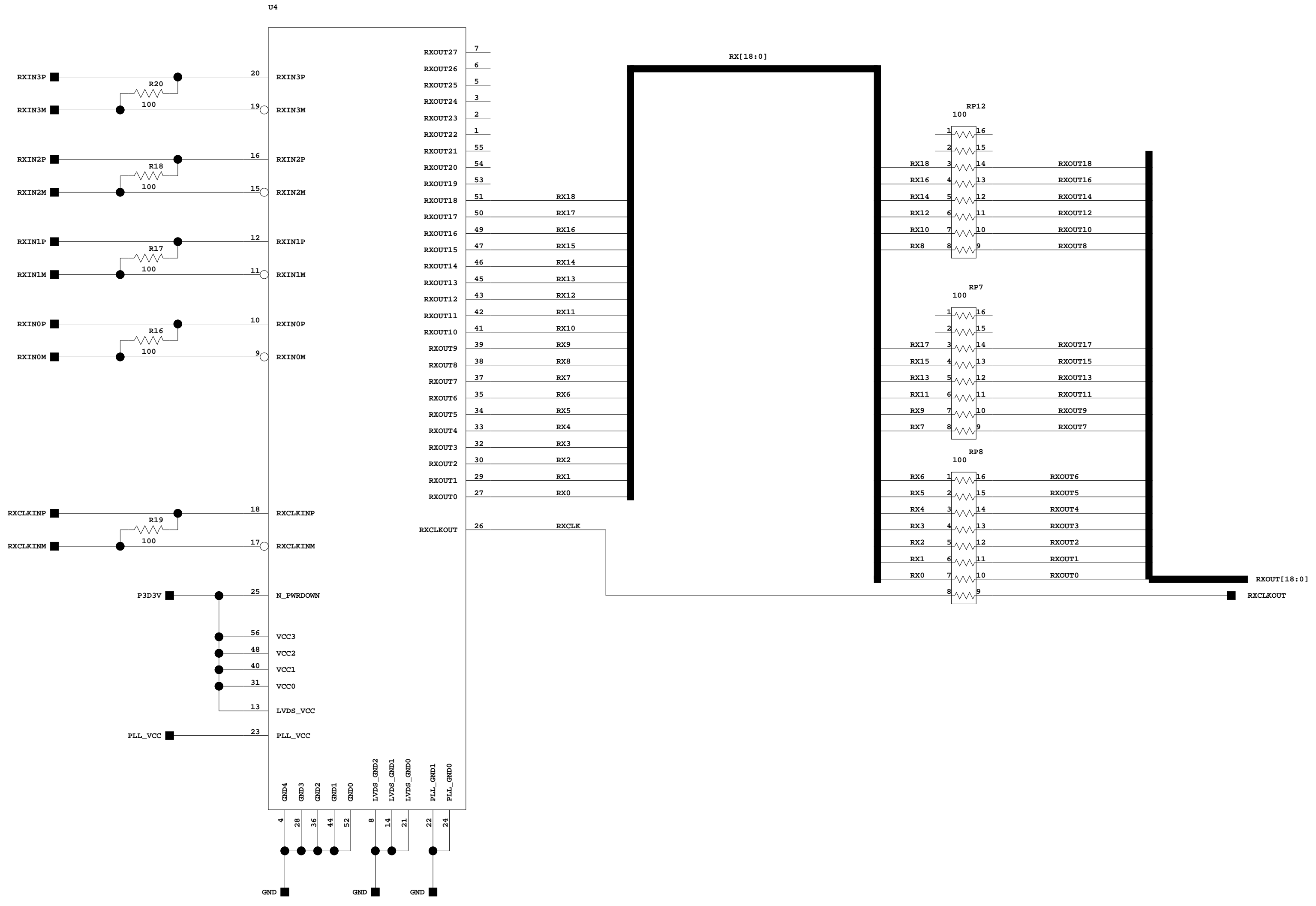

BABAR ZPDI AUXILIARY BD 2

LINK18. 1
4-25-2002_9:58

SHEET 14 OF 29

STANFORD LINEAR ACCELERATOR CENTER U.S. DEPARTMENT OF ENERGY		
STANFORD UNIVERSITY	STANFORD, CALIFORNIA	
PROPRIETARY DATA OF STANFORD UNIVERSITY AND/OR U.S. DEPARTMENT OF ENERGY. RECIPIENT SHALL NOT PUBLISH THE INFORMATION WITHIN UNLESS GRANTED SPECIFIC PERMISSION OF STANFORD UNIVERSITY.		
ENGR	DATE	APPROVALS
Jeff Olsen	04/09/02	
OPTR		
CHKA		

BABAR
ZPDI
AUXILIARY BOARD 2

SD-350-755-23-R01

D

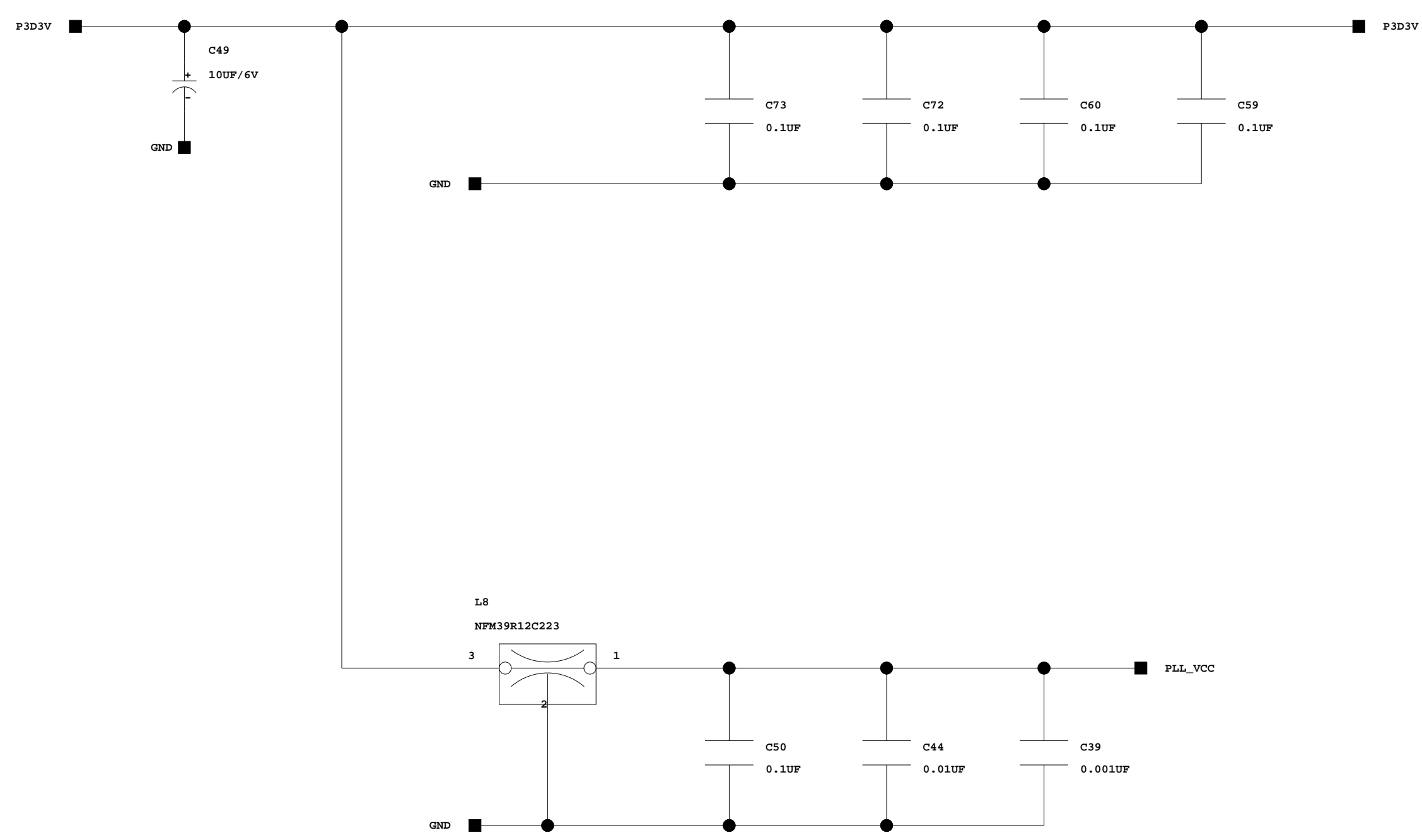
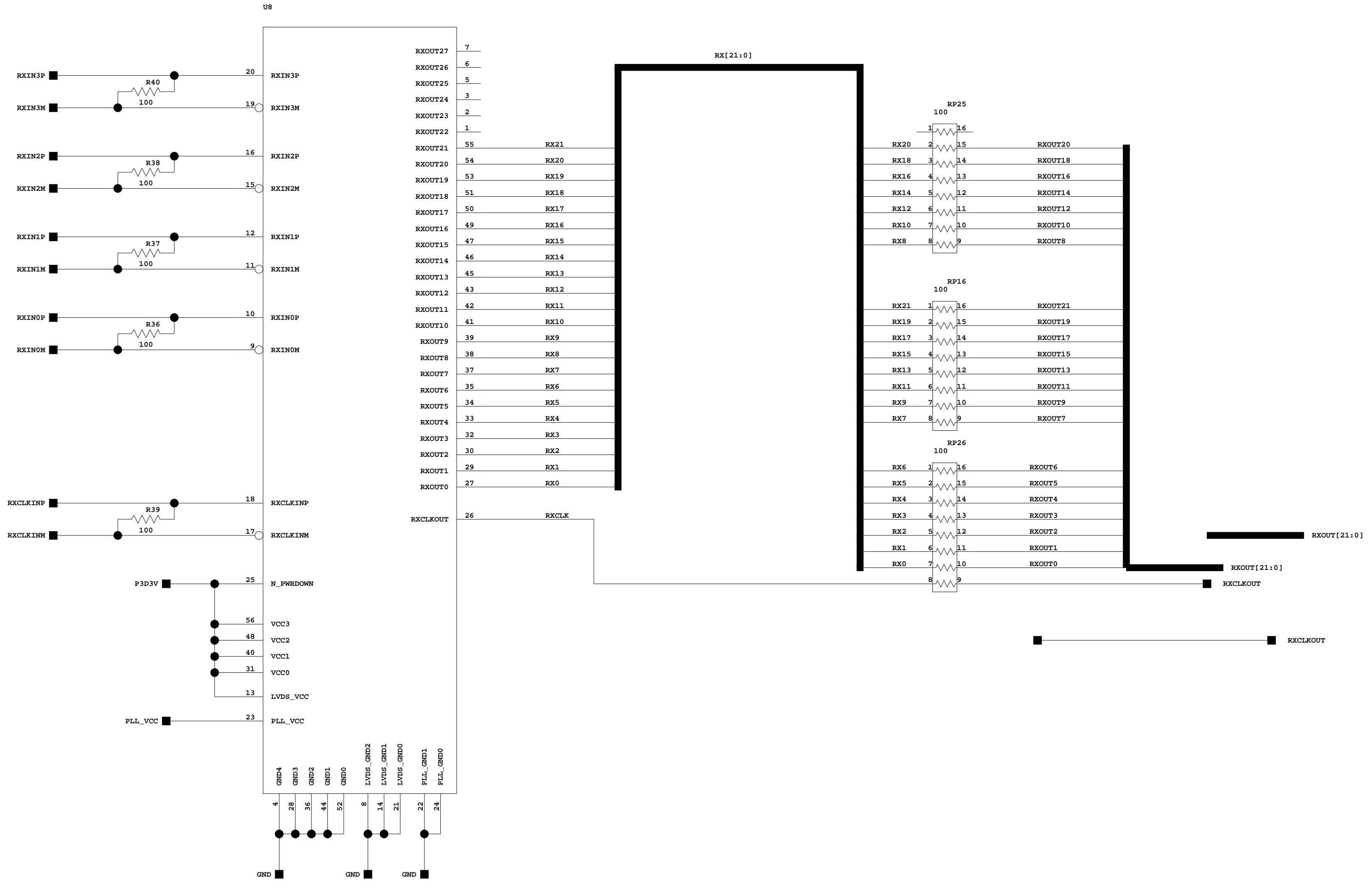

BABAR ZPDI AUXILIARY BD 2

LINK21. 1
4-25-2002_9:58

SHEET 15 OF 29

STANFORD LINEAR ACCELERATOR CENTER U.S. DEPARTMENT OF ENERGY		STANFORD, CALIFORNIA
PROPRIETARY DATA OF STANFORD UNIVERSITY AND/OR U.S. DEPARTMENT OF ENERGY. RECIPIENT SHALL NOT PUBLISH THE INFORMATION WITHIN UNLESS GRANTED SPECIFIC PERMISSION OF STANFORD UNIVERSITY.		
ENGR	DATE	APPROVALS
Jeff Olsen	04/09/02	
DATE		
CHKD		

BABAR
ZPDI
AUXILIARY BOARD 2

SD-350-755-23-R01

D

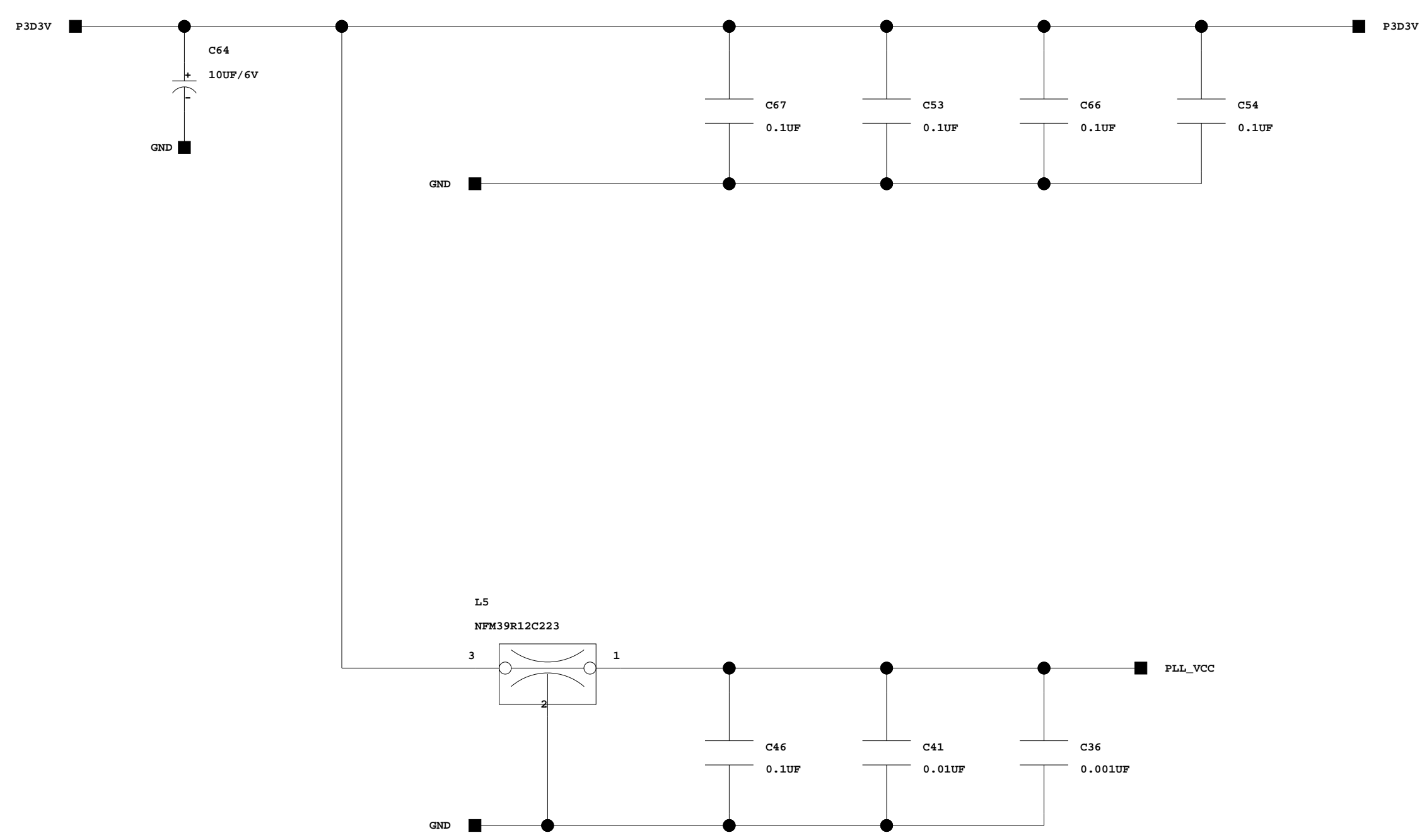
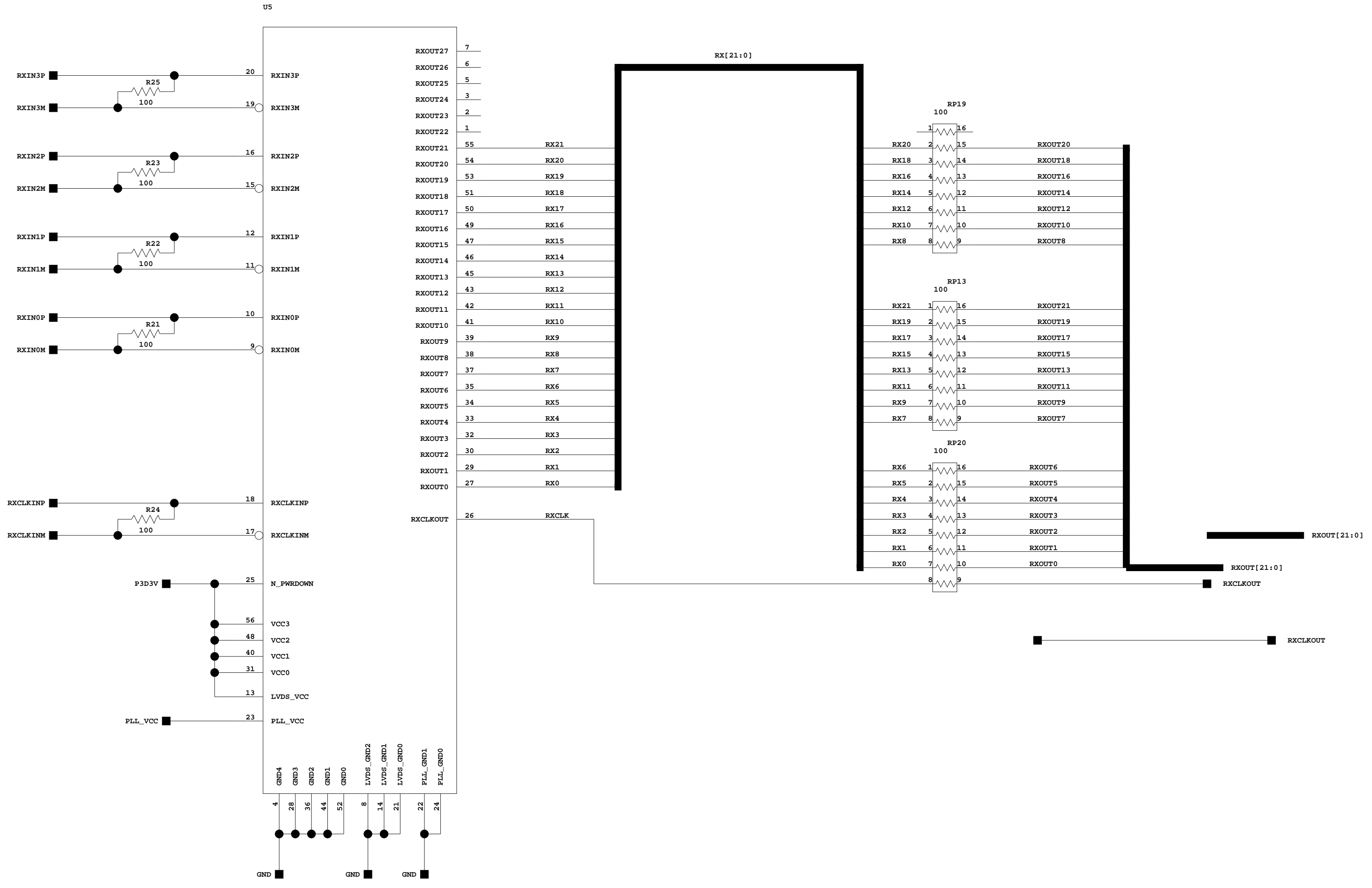

BABAR ZPDI AUXILIARY BD 2

LINK21. 1
4-25-2002_9:58

SHEET 5 OF 29

STANFORD LINEAR ACCELERATOR CENTER U.S. DEPARTMENT OF ENERGY		
STANFORD UNIVERSITY	STANFORD, CALIFORNIA	
PROPRIETARY DATA OF STANFORD UNIVERSITY AND/OR U.S. DEPARTMENT OF ENERGY. RECIPIENT SHALL NOT PUBLISH THE INFORMATION WITHIN UNLESS GRANTED SPECIFIC PERMISSION OF STANFORD UNIVERSITY.		
ENGR	DATE	APPROVALS
Jeff Olsen	04/09/02	
OPTR		
CHKD		

BABAR
ZPDI
AUXILIARY BOARD 2

SD-350-755-23-R01

D

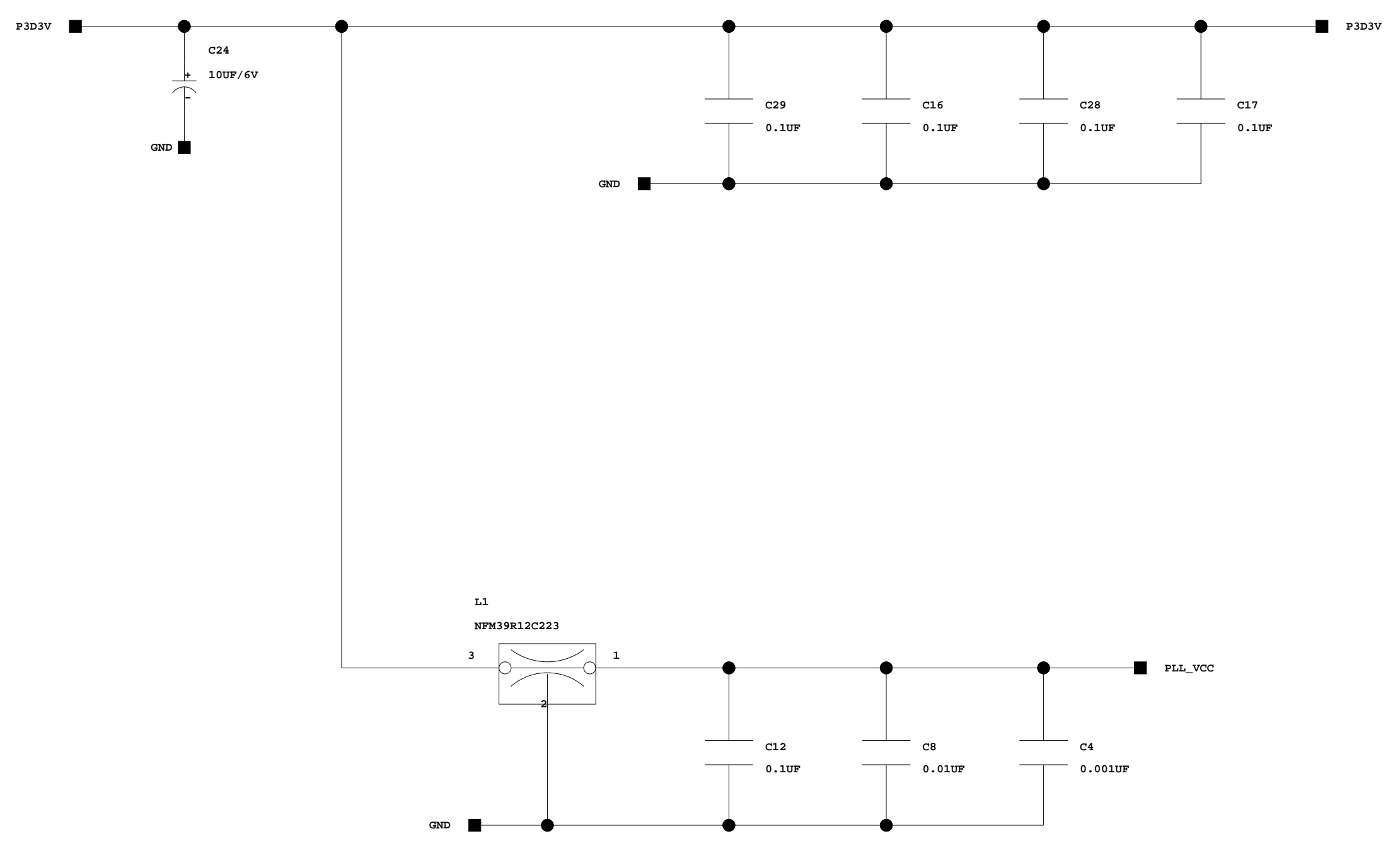
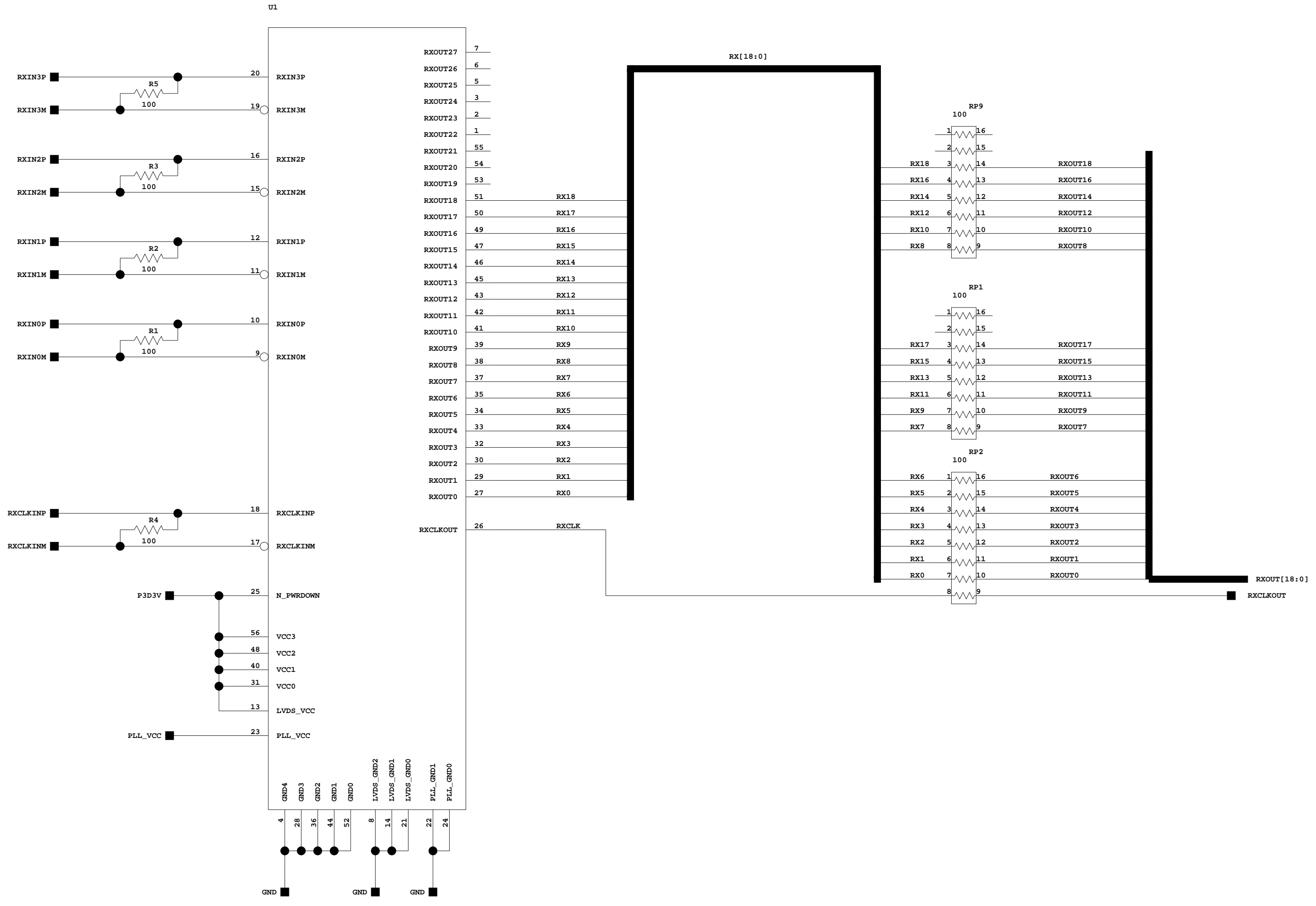

BABAR ZPDI AUXILIARY BD 2

LINK18. 1
4-25-2002_9:58

SHEET 4 OF 29

STANFORD LINEAR ACCELERATOR CENTER U.S. DEPARTMENT OF ENERGY	
STANFORD UNIVERSITY	STANFORD, CALIFORNIA
PROPRIETARY DATA OF STANFORD UNIVERSITY AND/OR U.S. DEPARTMENT OF ENERGY. RECIPIENT SHALL NOT PUBLISH THE INFORMATION WITHIN UNLESS GRANTED SPECIFIC PERMISSION OF STANFORD UNIVERSITY.	
ENGR Jeff Olsen	DATE 04/09/02
DFT	APPROVALS
CHKD	

BABAR
ZPDI
AUXILIARY BOARD 2

SD-350-755-23-R01

D

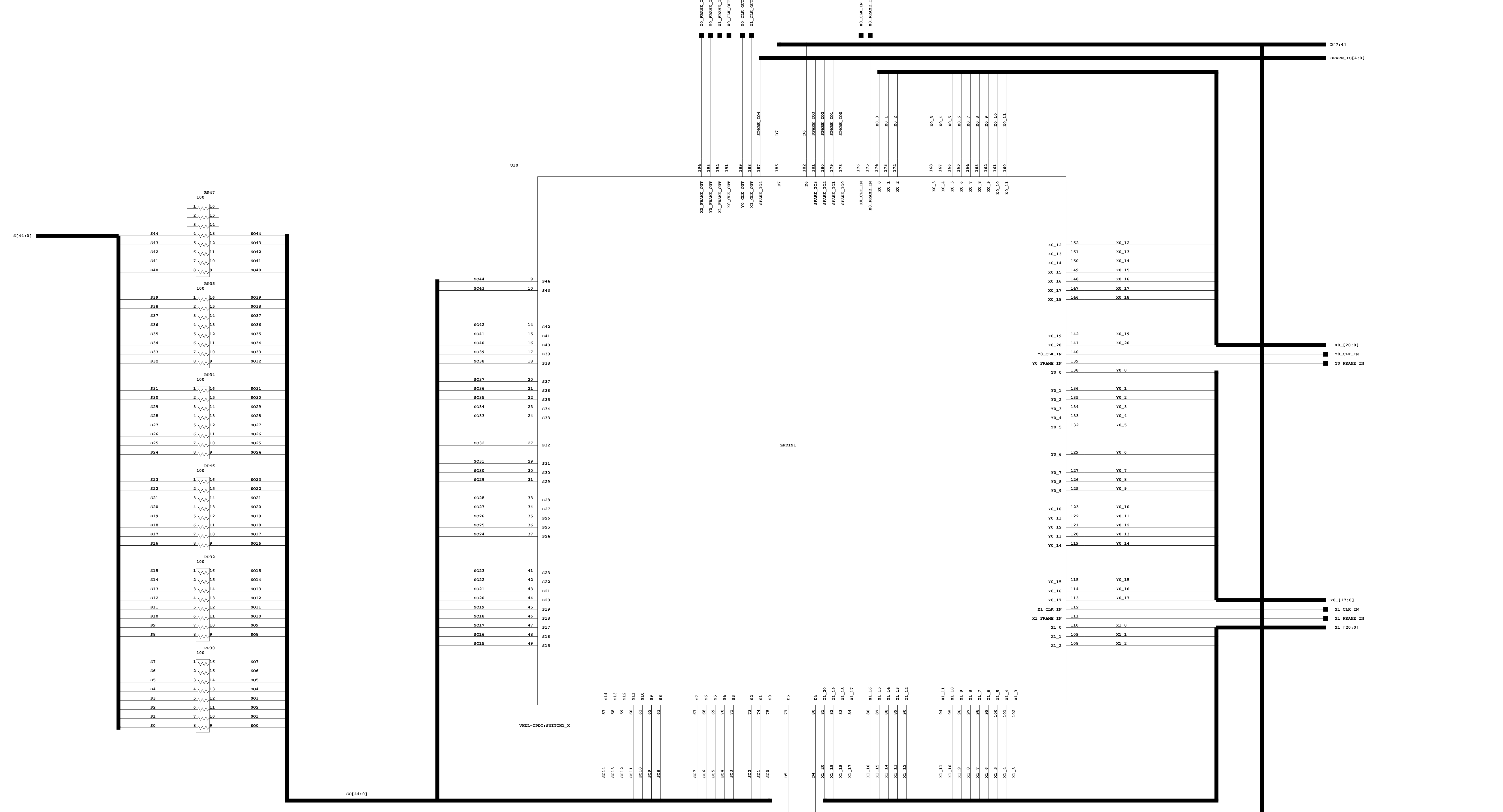

SO[44:0]

VIDL-ZPDI:SWITCH1_X

BABAR ZPDI AUXILIARY BD 2

SWITCH1. 1
4-25-2002_9:58

STANFORD LINEAR ACCELERATOR CENTER U.S. DEPARTMENT OF ENERGY	
STANFORD UNIVERSITY	STANFORD, CALIFORNIA
PROPRIETARY DATA OF STANFORD UNIVERSITY AND/OR U.S. DEPARTMENT OF ENERGY. RECIPIENT SHALL NOT PUBLISH THE INFORMATION WITHIN UNLESS GRANTED SPECIFIC PERMISSION OF STANFORD UNIVERSITY.	
DATE	APPROVALS
04/09/02	
BY	
JEFF OLSEN	
CHKD	

SHEET 6 OF 29	
BABAR ZPDI AUXILIARY BOARD 2	
SD-350-755-23-R01	